

---

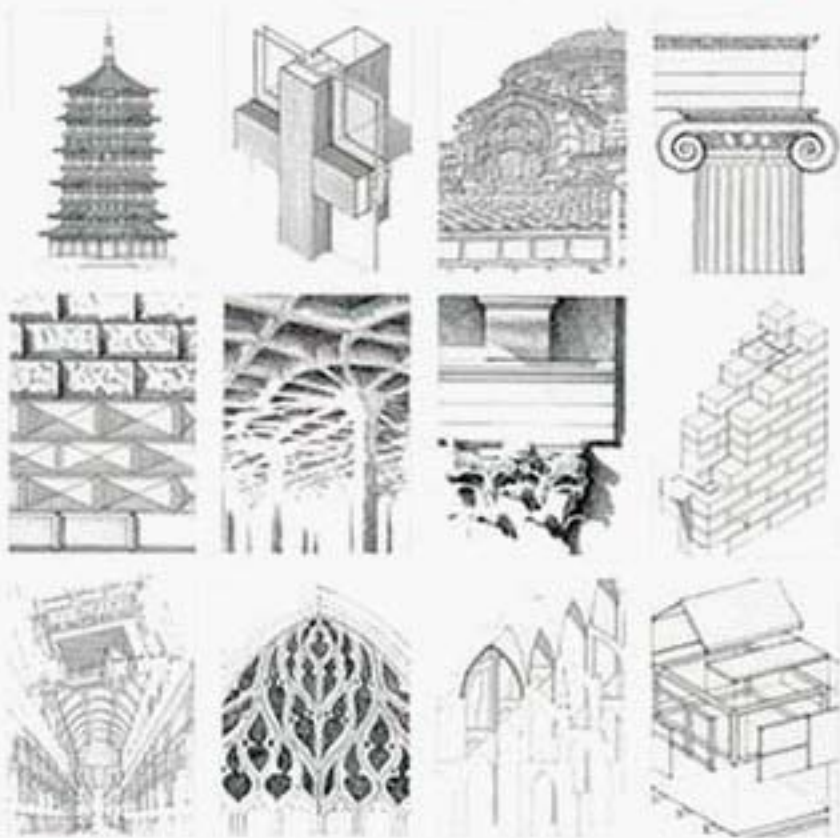
A VISUAL DICTIONARY OF

# Architecture



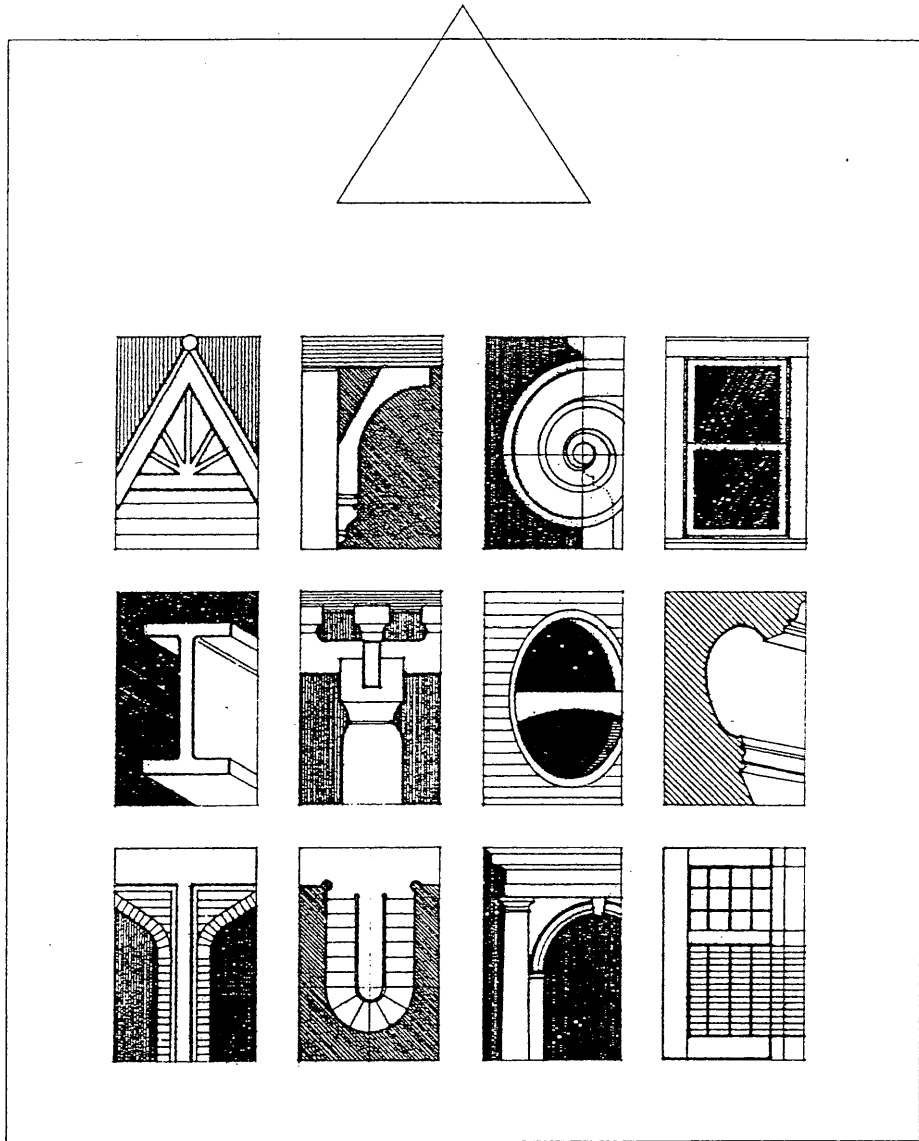
FRANCIS D.K. CHING

A VISUAL DICTIONARY OF  
**ARCHITECTURE**



FRANCIS D.K. CHING

A  
VISUAL DICTIONARY  
OF  
**ARCHITECTURE**



**FRANCIS D.K. CHING**

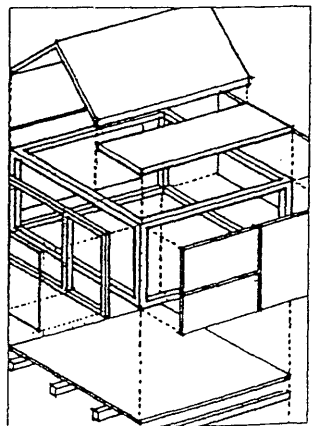
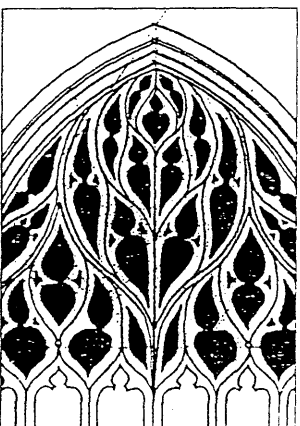
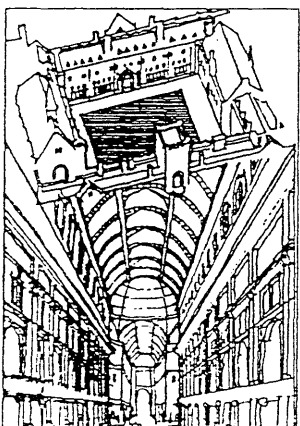
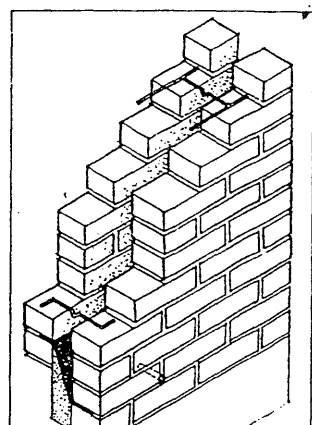
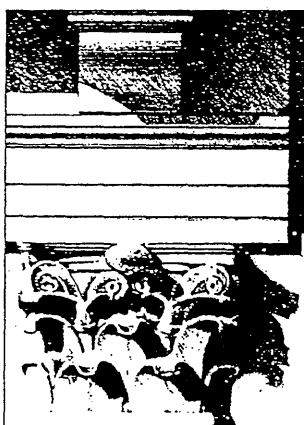
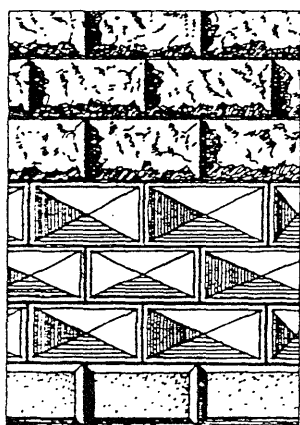
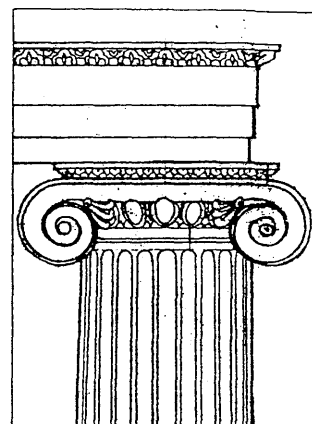
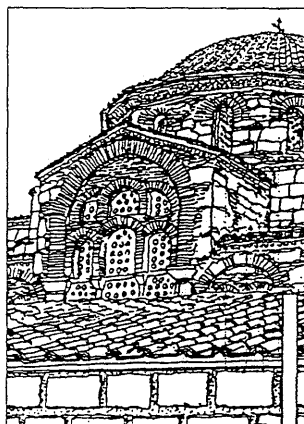
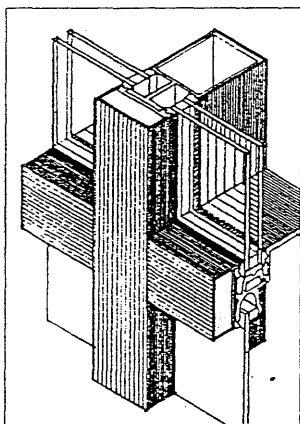
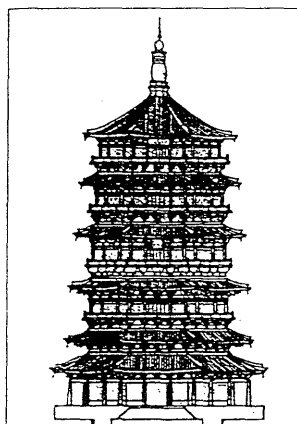
A VNR BOOK



**JOHN WILEY & SONS, INC.**

NEW YORK CHICHESTER WEINHEIM BRISBANE SINGAPORE TORONTO

# A VISUAL DICTIONARY OF ARCHITECTURE



ARCH.  
FRANCIS D.K. CHING  
FERNANDEZ



This book is printed on acid-free paper. ☺

Copyright © 1995 by John Wiley & Sons, Inc. All rights reserved.

Published simultaneously in Canada.

No part of this publication may be reproduced, stored in a retrieval system or transmitted in any form or by any means, electronic, mechanical, photocopying, recording, scanning or otherwise, except as permitted under Sections 107 or 108 of the 1976 United States Copyright Act, without either the prior written permission of the Publisher, or authorization through payment of the appropriate per-copy fee to the Copyright Clearance Center, 222 Rosewood Drive, Danvers, MA 01923, (978) 750-8400, fax (978) 750-4744. Requests to the Publisher for permission should be addressed to the Permissions Department, John Wiley & Sons, Inc., 605 Third Avenue, New York, NY 10158-0012, (212) 850-6011, fax (212) 850-6008, E-Mail: PERMREQ@WILEY.COM.

This publication is designed to provide accurate and authoritative information in regard to the subject matter covered. It is sold with the understanding that the publisher is not engaged in rendering professional services. If professional advice or other expert assistance is required, the services of a competent professional person should be sought.

Library of Congress Cataloging-in-Publication Data:

ISBN 0-471-28451-3

Printed in the United States of America.

20 19 18 17 16 15 14 13 12

# CONTENTS

---

PREFACE 7

## ARCHITECTURE 9

ARCH 12

BEAM 15

BRICK 18

BUILDING 21

CABLE STRUCTURE 28

CEILING 30

CERAMIC 32

CHURCH 35

COLOR 38

COLUMN 40

CONCRETE 42

CONSTRUCTION 48

DESIGN 52

DOME 60

DOOR 62

DRAWING 66

ELECTRICITY 74

ELEVATOR 80

FASTENING 82

FIREPLACE 87

FIRE SAFETY 88

FLOOR 92

FORCE 96

FORTIFICATION 98

FOUNDATION 100

FRAME 104

GEOMETRY 108

GLASS 112

HARDWARE 114

HEAT 117

HISTORY 128

HOUSE 136

JOINERY 140

LIGHT 142

LOAD 151

MASONRY 155

MATERIAL 161

MEASURE 166

MEMBRANE 168

METAL 169

MOISTURE CONTROL 176

ORDER 179

ORNAMENT 182

PAINT 187

PLASTER 188

PLASTIC 192

PLATE 194

PLUMBING 196

REINFORCED CONCRETE 202

ROOF 208

ROOM 216

SHELL 219

SITework 221

SOIL 224

SOLAR ENERGY 226

SOUND 228

STAIR 233

STONE 236

STRUCTURE 238

SURVEY 246

TEMPLE 248

THEATER 256

TRUSS 259

VAULT 262

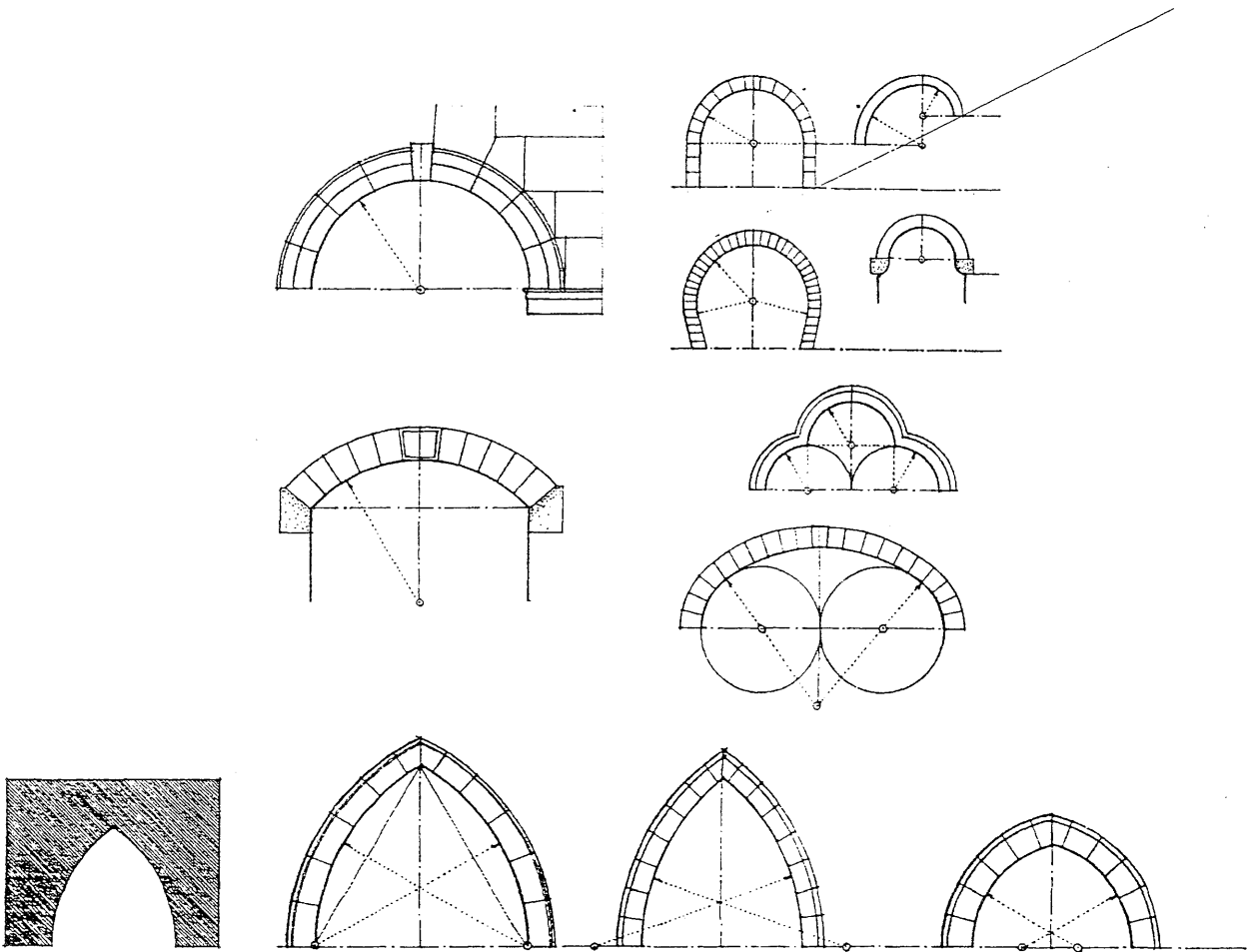
VISION 264

WALL 266

WINDOW 271

WOOD 276

INDEX 285



*One picture is worth a thousand words*

Just as a single image can be worth a thousand words, a single word can conjure up in the mind's eye a thousand images. Regardless of the power of a solitary word or image, however, each communicates meaning more effectively when brought together into a single presentation. The symbiotic relationship between graphic and verbal communication is the basis for this visual dictionary of architecture.

Instead of an alphabetical listing of entries as found in most dictionaries, the information is clustered around basic aspects of architecture as outlined in the table of contents. Within each section, words are placed in a visual context which further explains, clarifies, and completes their meaning.

The reader may use this dictionary in a number of ways. If one knows the exact term and wants to find out its meaning, then one can look it up in the index. Looking up one term will always present related terms arranged around one or more illustrations.

If one does not know the precise term, then one can look up the general subject either in the table of contents or the index. One can then refer to the appropriate section, browse the illustrations, and scan for the terms. While browsing, if one encounters an entry or a word used in a definition that is unfamiliar, one can look it up in the index.

Included are fundamental terms relating to architectural design, history, and technology. Since architecture is a visual art, most of the entries naturally lend themselves to graphic representation. Some are more abstract but are included to help clarify related terms or to complete the treatment of a subject. Others are inserted simply because they are of historical interest.

This is a book for the curious to browse as well as a desktop reference for the student of architecture. The compilation of words and definitions is not intended to be exhaustive. Rather, the selection is designed to be comprehensive enough to reflect the rich, complex, and multidimensional nature of architecture.

---

Architecture is an art for all to learn because all are concerned with it. –John Ruskin • Architecture depends on Order, Arrangement, Eurythmy, Symmetry, Propriety, and Economy. All of these must be built with due reference to durability, convenience, and beauty. Durability will be assured when foundations are carried down to the solid ground and materials wisely and liberally selected; convenience, when the arrangement of the apartments is faultless and presents no hindrance to use, and when each class of building is assigned to its suitable and appropriate exposure; and beauty, when the appearance of the work is pleasing and in good taste, and when its members are in due proportion according to correct principles of symmetry. –Vitruvius • Architecture is the mastery, correct and magnificent play of masses brought together in light. –Le Corbusier • Anyone entering on the study of architecture must understand that even though a plan may have abstract beauty on paper, the four facades may seem well-balanced and the total volume well-proportioned, the building itself may turn out to be poor architecture. Internal space, that space which cannot be completely represented in any form, which can be grasped and felt only through direct experience, is the protagonist of architecture. To grasp space, to know how to see it, is the key to the understanding of building. –Bruno Zevi • Architecture, painting, and sculpture are called the fine arts. They appeal to the eye as music does to the ear. But architecture is not judged by visual appeal alone. Buildings affect all of the human senses – sound, smell, touch, taste, and vision. –Forrest Wilson • It became apparent to us that architecture is generally assumed to be a highly specialized system with a set of prescribed technical goals rather than a sensual social art responsive to real human desires and feelings. This limitation is most frighteningly manifested in the reliance on two-dimensional diagrams that lay more stress on the quantifiable features of building organization than on the polychromatic and three-dimensional qualities of the whole architectural experience. –Kent Bloomer & Charles Moore • The only way you can build, the only way you can get the building into being, is through the measurable. You must follow the laws of nature and use quantities of brick, methods of construction, and engineering. But in the end, when the building becomes part of living, it evokes unmeasurable qualities, and the spirit of its existence takes over. –Louis Kahn • Built environments have various purposes: to shelter people and their activities and possessions from the elements, from human and animal enemies, and from supernatural powers; to establish place; to create a humanized, safe area in a profane and potentially dangerous world; to stress social identity and indicate status; and so on. Thus the origins of architecture are best understood if one takes a wider view and considers sociocultural factors, in the broadest sense, to be more important than climate, technology, materials, and economy. In any situation, it is the interplay of all these factors that best explains the form of buildings. No single explanation will suffice, because buildings – even apparently humble dwellings – are more than material objects or structures. They are institutions, basic cultural phenomena. People think environments before they build them. Thought orders space, time, activity, status, roles, and behavior. But giving physical expression to ideas is valuable. Encoding ideas makes them useful mnemonics; ideas help behavior by reminding people of how to act, how to behave, and what is expected of them. It is important to stress that all built environments – buildings, settlements, and landscapes – are one way of ordering the world by making ordering systems visible. The essential step, therefore, is the ordering or organizing of the environment. –Amos Rapaport • Ruskin said: 'Great nations write their autobiographies in three manuscripts, the book of their deeds, the book of their words and the book of their art. Not one of these books can be understood unless we read the two others, but of the three the only trustworthy one is the last.' On the whole I think this is true. If I had to say which was telling the truth about society, a speech by a minister of housing or the actual buildings put up in his time, I should believe the buildings. –Kenneth Clark • We require of any building, that it act well, and do the things it was intended to do in the best way; that it speak well, and say the things it was intended to say in the best words; that it look well, and please us by its presence, whatever it has to do or say. –John Ruskin • Architecture also exists without necessary assistance from an architect; and architects sometimes create buildings which are not architecture. –Norval White • Architecture is produced by ordinary people, for ordinary people; therefore it should be easily comprehensible to all. –Steen Eiler Rasmussen

# ARCHITECTURE

The **ART**

*architecture* The product or result of architectural work: buildings, collectively.

and **SCIENCE**

*architecture* A style or method of building characteristic of a people, place, or time.

of **DESIGNING**

*architecture* The profession of designing buildings and other habitable environments.

and **CONSTRUCTING**

*architecture* The conscious act of forming things resulting in a unifying or coherent structure.

## BUILDINGS

# ARCHITECTURE

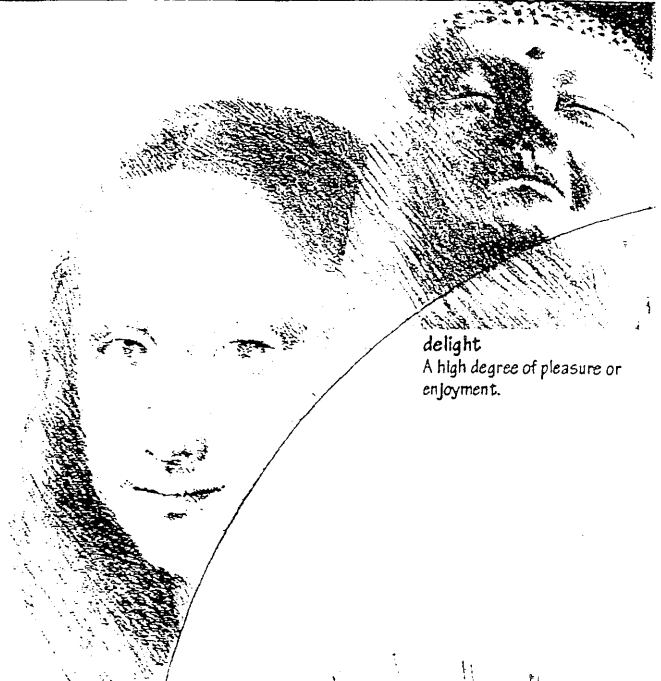
**art**  
The conscious use of skill, craft, and creative imagination in the production of what is beautiful, appealing, or of more than ordinary significance.



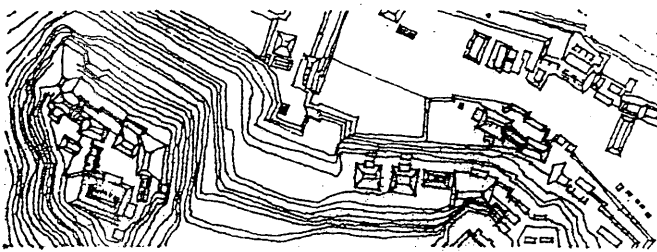
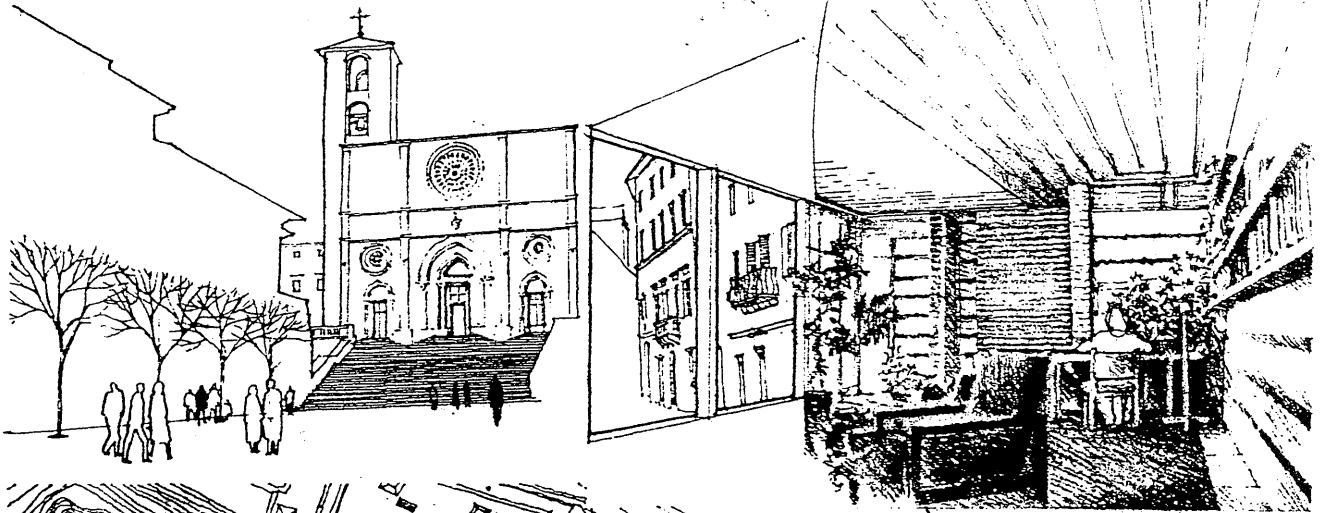
**aesthetics**  
The branch of philosophy that deals with the nature of art, beauty, and taste, with a view to establishing the meaning and validity of critical judgments concerning works of art. Also, esthetics.

**beauty**  
The aggregate of qualities in a person or thing that gives intense pleasure to the senses or deep satisfaction to the mind or spirit, whether arising from harmony of form or color, excellence of craft, truthfulness, originality, or other, often unspecifiable property.

**taste**  
Critical judgment, discernment, or appreciation of what is fitting, harmonious, or beautiful prevailing in a culture or personal to an individual.



**delight**  
A high degree of pleasure or enjoyment.



**commodity**  
Something of value, use, or convenience.

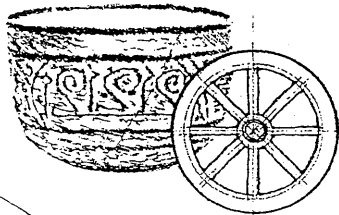
**environmental design**  
The ordering of the physical environment by means of architecture, engineering, construction, landscape architecture, urban design, and city planning.

**urban design**  
The aspect of architecture and city planning that deals with the design of urban structures and spaces.

**interior design**  
The art, business, or profession of planning the design and supervising the execution of architectural interiors, including their color schemes, furnishings, fittings, finishes, and sometimes architectural features.

**city planning**  
The activity or profession of determining the future physical arrangement and condition of a community, involving an appraisal of the current conditions, a forecast of future requirements, a plan for the fulfillment of these requirements, and proposals for legal, financial, and constructional programs to implement the plan. Also called town planning, urban planning.

**space planning**  
The aspect of architecture and interior design that deals with the planning, layout, design, and furnishing of spaces within a proposed or existing building.



**technology**

Applied science: the branch of knowledge that deals with the creation and use of technical methods and materials, and their interrelation with life, society, and the environment.

**technics**

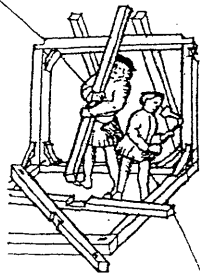
The science of an art or of the arts in general.

**tectonics**

The science or art of shaping, ornamenting, or assembling materials in construction.

**architectonics**

The unifying structure or concept of an artistic work.

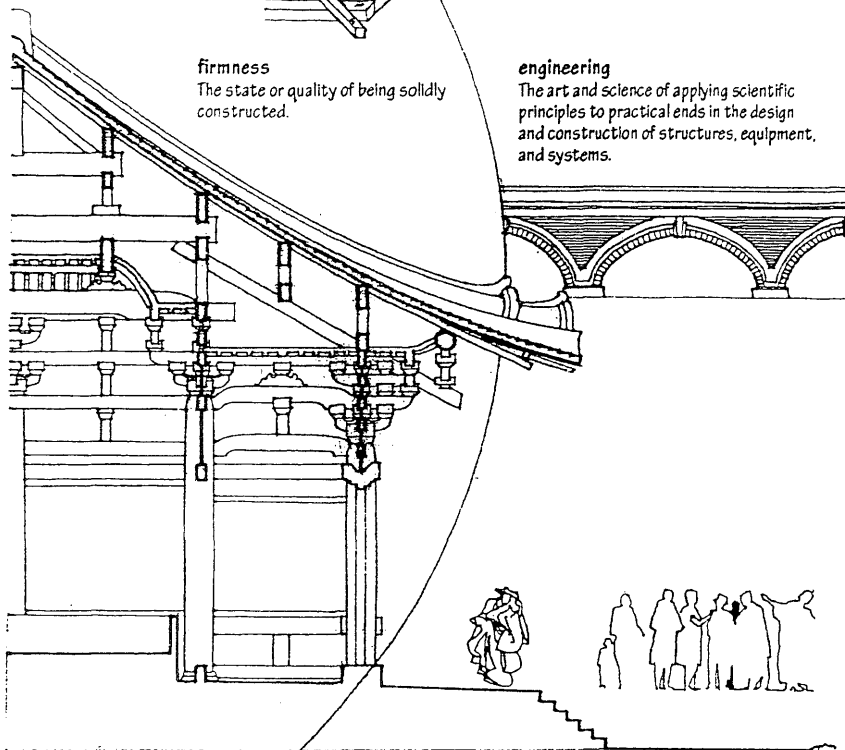


**firmness**

The state or quality of being solidly constructed.

**engineering**

The art and science of applying scientific principles to practical ends in the design and construction of structures, equipment, and systems.



**behavioral science**

Any of the sciences, as sociology and anthropology, that seek to discover general truths from the observation of human behavior in society.

**sociology**

The science of human social institutions and relationships; specif. the study of the origin, development, structure, functioning, and collective behavior of organized groups of human beings.

**anthropology**

The science of human beings; specif. the study of the origins, physical and cultural development, and environmental and social relations of humankind.



**landscape architecture**

The art, business, or profession of designing, arranging, or modifying the features of a landscape for aesthetic or practical reasons.





# ARCH

A curved structure for spanning an opening, designed to support a vertical load primarily by axial compression.

## masonry arch

An arch constructed of individual stone or brick voussoirs.

## vousoir

Any of the wedge-shaped units in a masonry arch or vault, having side cuts converging at one of the arch centers.

## springer

The first voussoir resting on the impost of an arch.

## keystone

The wedge-shaped, often embellished voussoir at the crown of an arch, serving to lock the other voussoirs in place.

## extrados

The exterior curve, surface, or boundary of the visible face of an arch. Also called back.

## archivolt

A decorative molding or band on the face of an arch following the curve of the intrados.

## intrados

The inner curve or surface of an arch forming the concave underside.

## rise

The height of an arch from the springing line to the highest point of the intrados.

## spring

The point at which an arch, vault, or dome rises from its support. Also called springing.

## crown

The highest part or point of a convex construction, as an arch, vault, or roadway.

## haunch

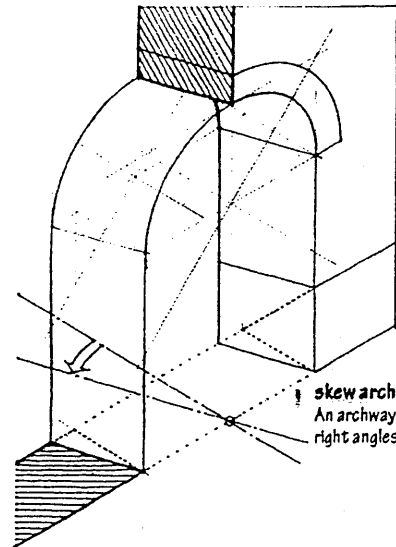
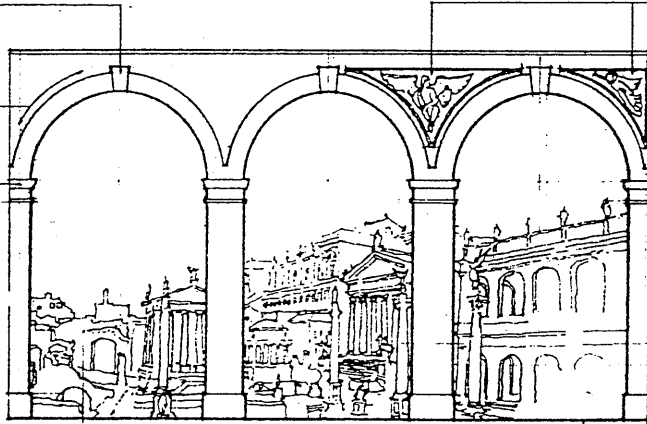
Either side of an arch curving down from the crown to the impost.

## impost

The uppermost part of an abutment, often in the form of a block, capital, or molding, from which an arch springs.

## spandrel

The triangular-shaped, sometimes ornamented area between the extrados of two adjoining arches, or between the left or right extrados of an arch and the rectangular framework surrounding it. Also, spandril.



## skew arch

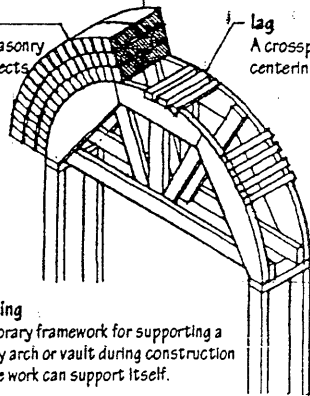
An archway having sides or jambs not at right angles with the face of its abutments.

## order

Any of several concentric rings of masonry forming an arch, esp. when each projects beyond the one below.

## lag

A crosspiece connecting the ribs in a centering. Also called bolster.

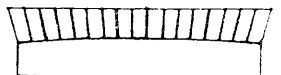


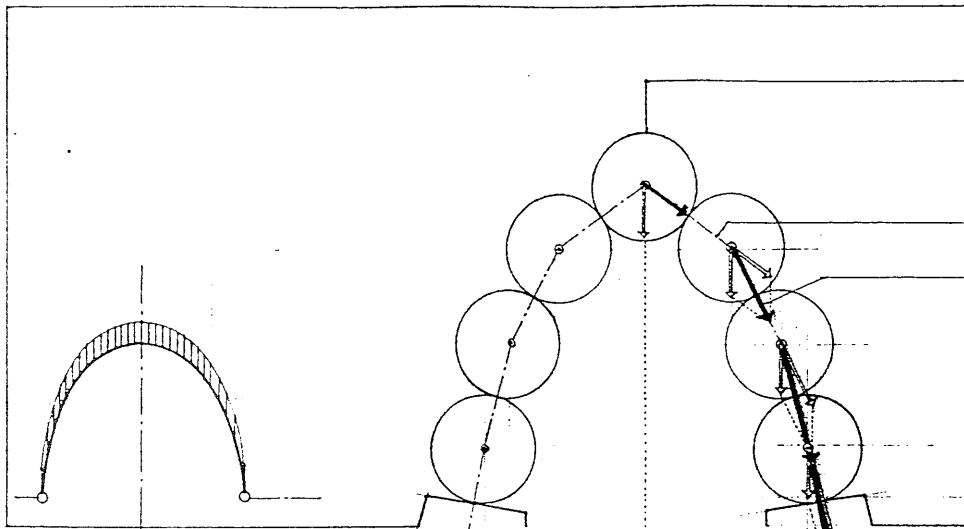
## centering

A temporary framework for supporting a masonry arch or vault during construction until the work can support itself.

## camber piece

A board used as centering for a flat arch, slightly crowned to allow for settling of the arch. Also called camber slip.





**arch action**  
The manner in which an arch transforms the vertical forces of a supported load into inclined components and transmits them to abutments on either side of the archway.

**arch axis**  
The median line of an arched structure.

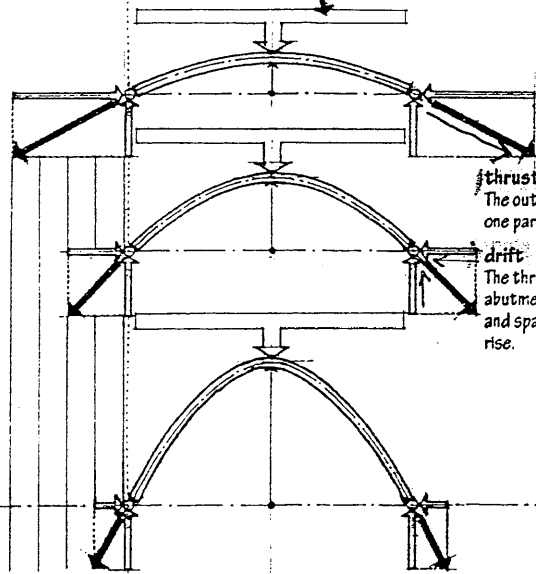
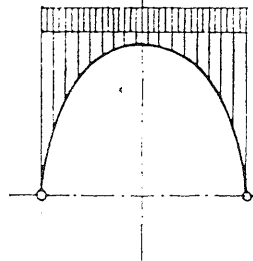
**line of thrust**  
The set of resultants of thrust and weight each part of an arch imposes on the next lower one. For bending to be eliminated throughout an arch, the line of thrust must coincide with the arch axis.

**funicular arch**

An arch shaped to develop only axial compression under a given loading. This shape may be found by inverting the funicular shape for a cable carrying a similar loading pattern. As with any funicular structure, a funicular arch is subject to bending if the loading pattern changes.

An inverted catenary is the funicular shape for an arch carrying a vertical load uniformly distributed along the length of the arch axis.

The parabola is the funicular shape for an arch carrying a vertical load uniformly distributed over its horizontal projection.



**thrust**  
The outward force or pressure exerted by one part of a structure against another.

**drift**  
The thrust of an arched structure on its abutments, proportional to the total load and span, and inversely proportional to the rise.

**rigid arch**

An arched structure of timber, steel, or reinforced concrete, constructed as a rigid body capable of carrying bending stresses.

**fixed arch**

A fixed frame structure having an arched form.

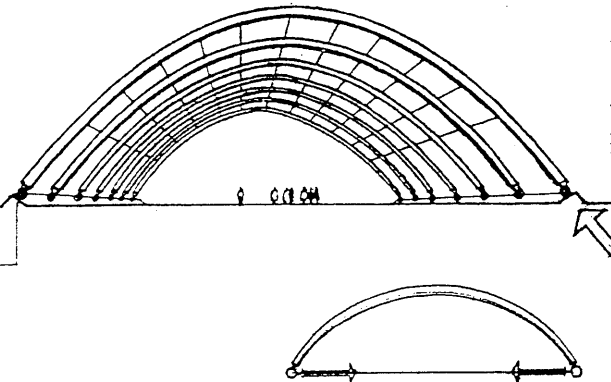
**two-hinged arch**

A two-hinged frame structure having an arched form.

**three-hinged arch**

A three-hinged frame structure having an arched form.

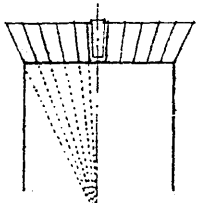
\* See frame structure



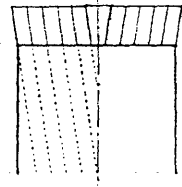
**abutment**  
The part of a structure receiving and supporting the thrust of an arch, vault, or strut.

**tie rod**  
An iron or steel rod serving as a structural tie, esp. one keeping the lower ends of an arch or frame from spreading.

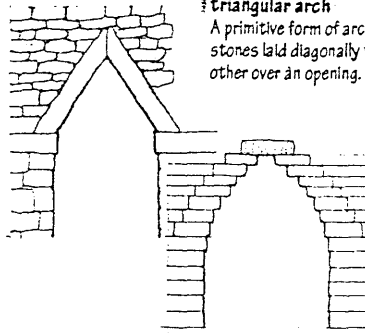
# ARCH



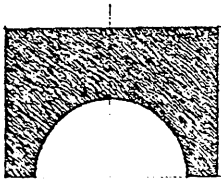
**flat arch**  
An arch having a horizontal intrados with voussoirs radiating from a center below, often built with a slight camber to allow for settling. Also called **jack arch**.



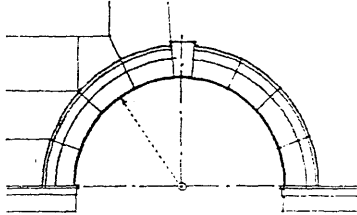
**French arch**  
A flat arch having voussoirs inclined to the same angle on each side of the center.



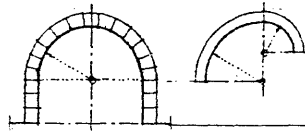
**triangular arch**  
A primitive form of arch consisting of two stones laid diagonally to support each other over an opening.



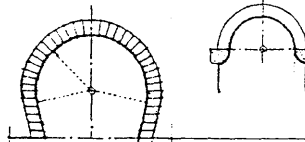
**round arch**  
An arch having a continuously curved intrados, esp. a semicircular one.



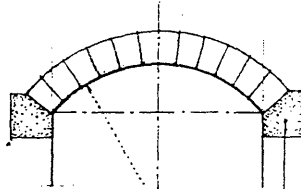
**Roman arch**  
An arch having a semicircular intrados.



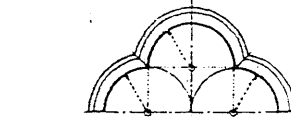
**rampant arch**  
An arch having one impost higher than the other.



**stilted arch**  
An arch resting on imposts treated as downward continuations of the archivolts.

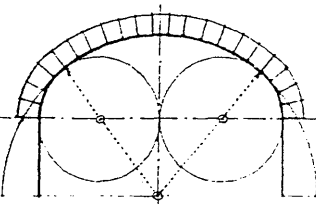


**segmental arch**  
An arch struck from one or more centers below the springing line.



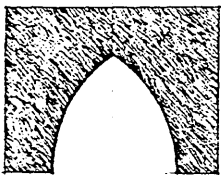
**bell arch**  
A round arch resting on two large corbels with curved faces.

**skewback**  
A stone or course of masonry having a sloping face against which the end of a segmental arch rests.

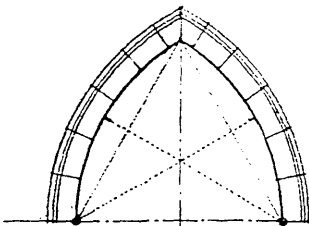


**horseshoe arch**  
An arch having an intrados that widens above the springing before narrowing to a rounded crown. Also called **Moorish arch**.

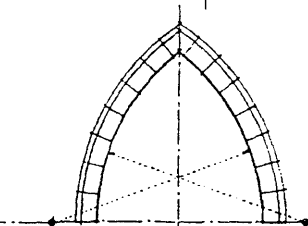
**trefoll arch**  
An arch having a cusped intrados with three round or pointed foils.



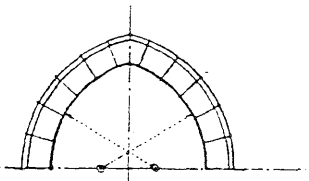
**pointed arch**  
An arch having a pointed crown.



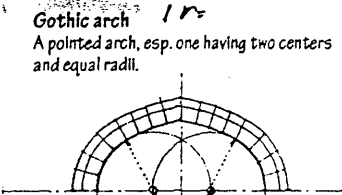
**equilateral arch**  $2r = s$   
A pointed arch having two centers and radii equal to the span.



**lancet arch**  
A pointed arch having two centers and radii greater than the span.

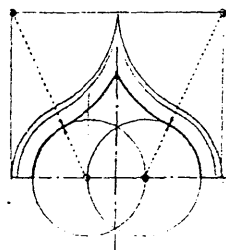


**drop arch**  
A pointed arch having two centers and radii less than the span.



**Gothic arch**  $1r = s$   
A pointed arch, esp. one having two centers and equal radii.

**Tudor arch**  $4r = s$   
A four-centered arch having an inner pair of curves with a radius much greater than that of the outer pair.

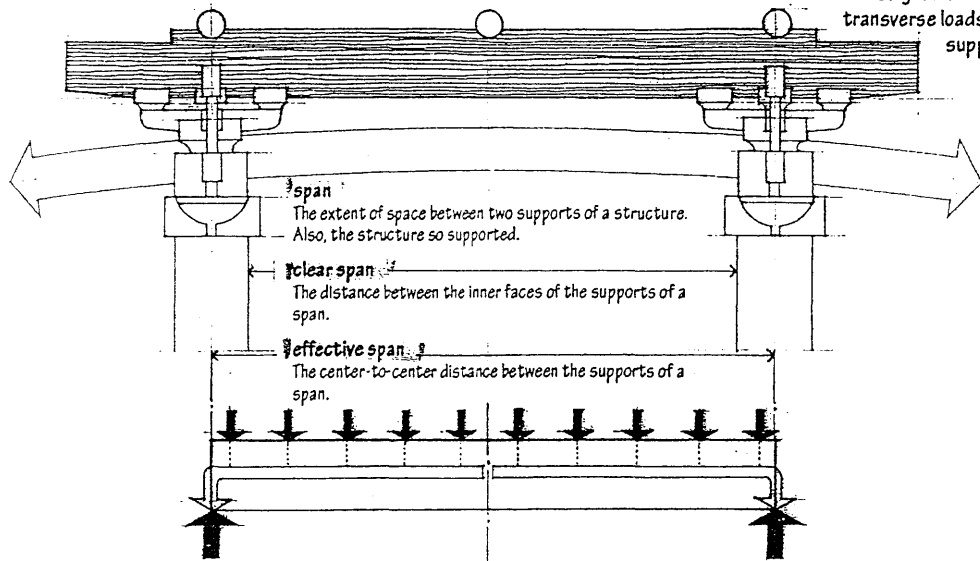


**surbased arch**  
An arch having a rise of less than half the span.

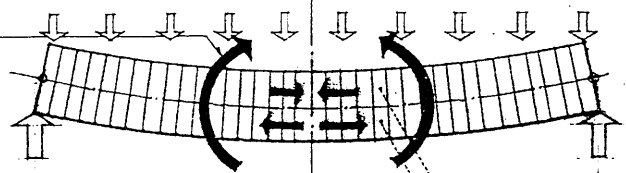
**ogee arch**  
A pointed arch, each haunch of which is a double curve with the concave side uppermost.

# BEAM

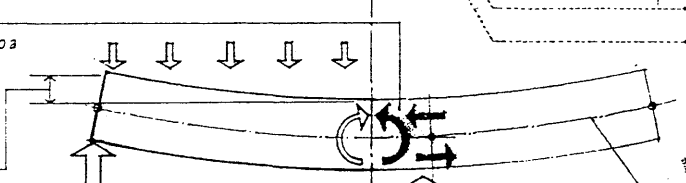
A rigid structural member designed to carry and transfer transverse loads across space to supporting elements.



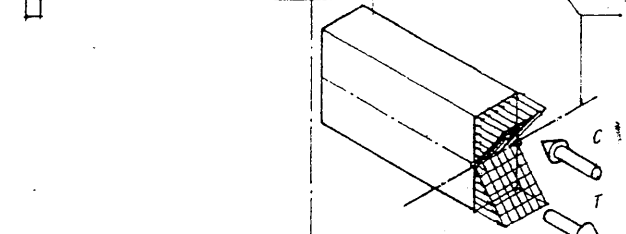
**bending moment**  
An external moment tending to cause part of a structure to rotate or bend, equal to the algebraic sum of the moments about the neutral axis of the section under consideration.



**resisting moment**  
An internal moment equal and opposite to a bending moment, generated by a force couple to maintain equilibrium of the section being considered.

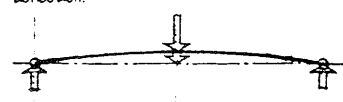


**deflection**  
The perpendicular distance a spanning member deviates from a true course under transverse loading, increasing with load and span, and decreasing with an increase in the moment of inertia of the section or the modulus of elasticity of the material.

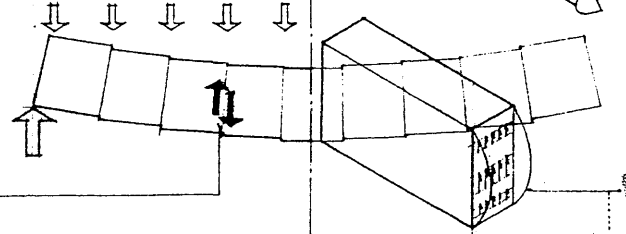


**neutral axis**  
An imaginary line passing through the centroid of the cross section of a beam or other member subject to bending, along which no bending stresses occur.

**camber**  
A slight convex curvature intentionally built into a beam, girder, or truss to compensate for an anticipated deflection.



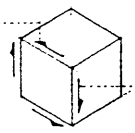
**transverse shear**  
An external shear force at a cross section of a beam or other member subject to bending, equal to the algebraic sum of transverse forces on one side of the section.



**bending stress**  
A combination of compressive and tension stresses developed at a cross section of a structural member to resist a transverse force, having a maximum value at the surface furthest from the neutral axis.

**vertical shearing stress**  
The shearing stress developed along a cross section of a beam to resist transverse shear, having a maximum value at the neutral axis and decreasing nonlinearly toward the outer faces.

**horizontal shearing stress**  
The shearing stress developed to prevent slippage along longitudinal planes of a beam under transverse loading, equal at any point to the vertical shearing stress at that point. Also called longitudinal shearing stress.



# BEAM

## flexure formula

A formula defining the relationship between bending moment, bending stress, and the cross-sectional properties of a beam. Bending stress is directly proportional to bending moment and inversely proportional to the moment of inertia of a beam section.

$$f_b = M/c \quad (1)$$

where

$f_b$  = extreme fiber stress in bending

$M$  = bending moment

$c$  = distance from neutral axis to the outermost surface in bending

if

$$1/c = S \quad (2)$$

then

$$f_b = M/S$$

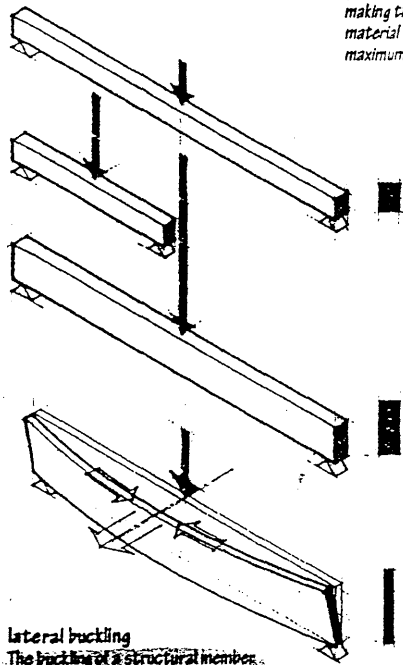
## moment of inertia

The sum of the products of each element of an area and the square of its distance from a coplanar axis of rotation. Moment of inertia is a geometric property that indicates how the cross-sectional area of a structural member is distributed and does not reflect the intrinsic physical properties of a material.

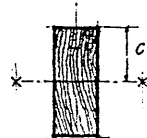
## section modulus

A geometric property of a cross section, defined as the moment of inertia of the section divided by the distance from the neutral axis to the most remote surface.

While halving a beam span reduces the bending stresses by a factor of 2, doubling the depth reduces the bending stresses by a factor of 4.



The efficiency of a beam is increased by configuring the cross section to provide the required moment of inertia or section modulus with the smallest possible area, usually by making the section deep with most of the material at the extremities where the maximum bending stresses occur.

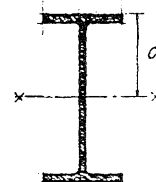


4 x 10 timber beam

$$33.25 \text{ in}^2 = \text{Area of section}$$

$$250 \text{ in}^4 = I \text{ about } x-x \text{ axis}$$

$$52.6 \text{ in}^3 = S$$



W 14 x 38 steel beam

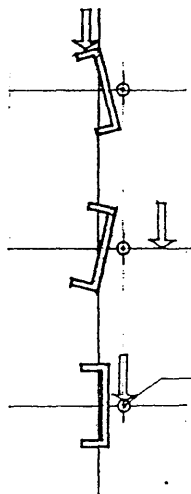
$$11.20 \text{ in}^2 = \text{Area of section}$$

$$386 \text{ in}^4 = I \text{ about } x-x \text{ axis}$$

$$54.7 \text{ in}^3 = S$$

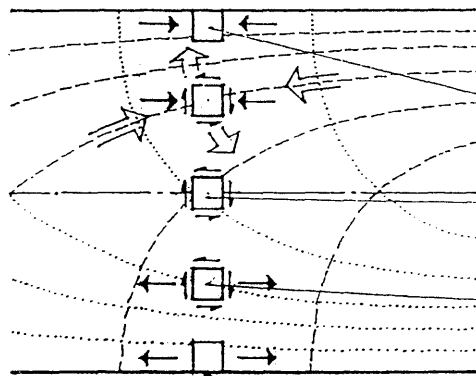
## lateral buckling

The buckling of a structural member induced by compressive stresses acting on a slender portion insufficiently rigid in the lateral direction.



## shear center

The point in the cross-sectional plane of a structural member through which a transverse load must pass in order to prevent torsion or twisting of the member about a longitudinal axis.



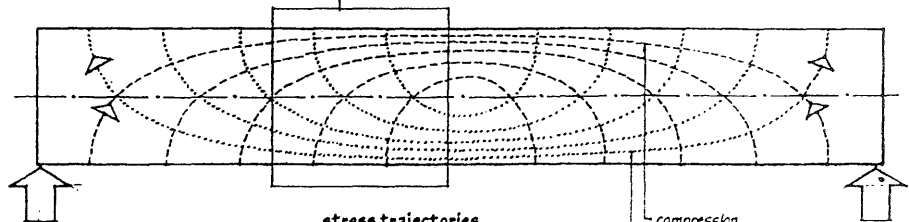
## principal stresses

The tensile and compressive stresses resulting from the interaction of bending and shear stresses at a cross section of a beam.

At the extreme surfaces of a beam, only bending stresses exist and the principal stresses are equivalent to the tensile and compressive stresses resulting from bending.

At the neutral axis of the section, only shear stresses exist and these can be resolved into tensile and compressive stresses acting at 45° angles to the neutral axis.

For an intermediate element subject to both bending and shear stresses, the principal stresses have an inclination determined by the relative magnitudes of these stresses.



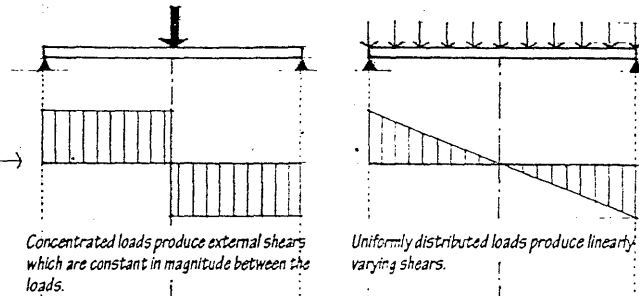
## stress trajectories

Lines depicting the direction but not the magnitude of the principal stresses in a beam.

compression  
tension

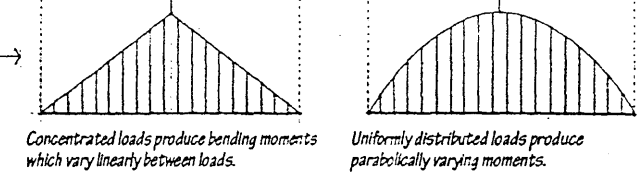
**shear diagram**

A graphic representation of the variation in magnitude of the external shears present in a structure for a given set of transverse loads and support conditions.



**moment diagram**

A graphic representation of the variation in magnitude of the bending moments present in a structure for a given set of transverse loads and support conditions. The overall deflected shape of a structure subject to bending can often be inferred from the shape of its moment diagram.

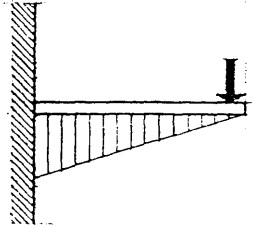


**simple beam**

A beam resting on simple supports at both ends, which are free to rotate and have no moment resistance. As with any statically determinate structure, the values of all reactions, shears, and moments for a simple beam are independent of its cross-sectional shape and material.

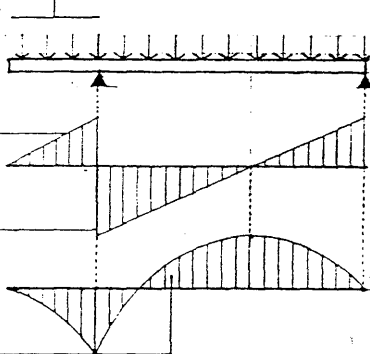
**cantilever beam**

A projecting beam supported at only one fixed end.



**cantilever**

A beam or other rigid structural member extending beyond a fulcrum and supported by a balancing member or a downward force behind the fulcrum.



**overhanging beam**

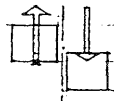
A simple beam extending beyond one its supports. The overhang reduces the positive moment at midspan while developing a negative moment at the base of the cantilever over the support.

Assuming a uniformly distributed load, the projection for which the moment over the support is equal and opposite to the moment at midspan is approximately 1/3 of the span.

**double overhanging beam**

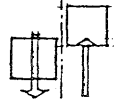
A simple beam extending beyond both of its supports.

Assuming a uniformly distributed load, the projections for which the moments over the supports are equal and opposite to the moment at midspan are approximately 1/3 of the span.



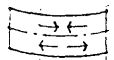
**positive shear**

A net resultant of shear forces that acts vertically upward on the left part of the structure being considered.



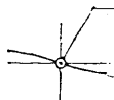
**negative shear**

A net resultant of shear forces that acts vertically downward on the left part of the structure being considered.



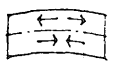
**positive moment**

A bending moment that produces a concave curvature at a section of a structure.



**inflection point**

A point at which a structure changes curvature from convex to concave or vice versa as it deflects under a transverse load; theoretically an internal hinge and therefore a point of zero moment.

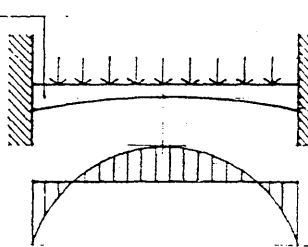


**negative moment**

A bending moment that produces a convex curvature at a section of a structure.

**haunch**

The part of a beam that is thickened or deepened to develop greater moment resistance. The efficiency of a beam can be increased by shaping its length in response to the moment and shear values which typically vary along its longitudinal axis.

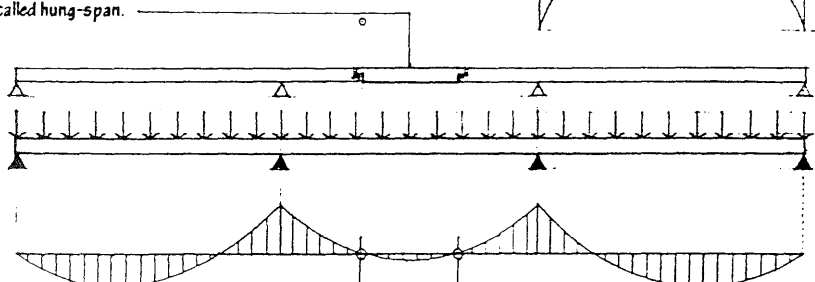


**fixed-end beam**

A beam having both ends restrained against translation and rotation. The fixed ends transfer bending stresses, increase the rigidity of the beam, and reduce its maximum deflection.

**suspended-span**

A simple beam supported by the cantilevers of two adjoining spans with pinned construction joints at points of zero moment. Also called hung-span.



**effective length**

The distance between inflection points in the span of a fixed-end or continuous beam, equivalent in nature to the actual length of a simply supported beam.

**continuous beam**

A beam extending over more than two supports in order to develop greater rigidity and smaller moments than a series of simple beams having similar spans and loading. Both fixed-end and continuous beams are indeterminate structures for which the values of all reactions, shears, and moments are dependent not only on span and loading but also on cross-sectional shape and material.

# BRICK

A masonry unit of clay, formed into a rectangular prism while plastic and hardened by drying in the sun or firing in a kiln.

## Common brick

Brick made for general building purposes and not specially treated for color and texture. Also called building brick.

## facing brick

Brick made of special clays for facing a wall, often treated to produce the desired color and surface texture. Also called face brick.

## brick type

A designation indicating the permissible variation in size, color, chippage, and distortion allowed in a facing brick unit.

### FBX

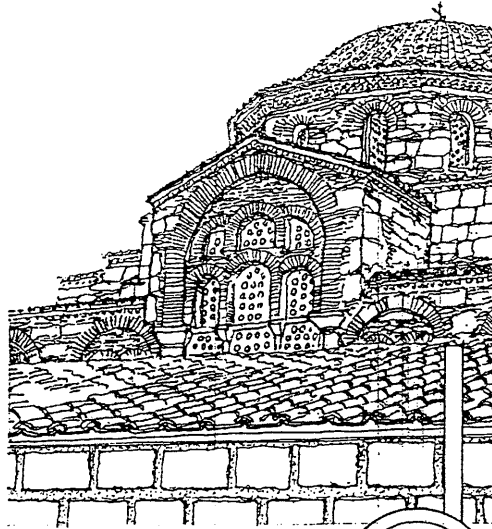
Facing brick suitable for use where a minimum variation in size, narrow color range, and high degree of mechanical perfection are required.

### FBS

Facing brick suitable for use where a wider color range and greater variation in size are permitted than for type FBX.

### FBA

Facing brick suitable for use where particular effects are desired resulting from nonuniformity in size, color, and texture of the individual units.



## soft-mud process

The process of forming brick by molding relatively wet clay having a moisture content of 20% to 30%.

## sandstruck brick

Brick formed in the soft-mud process with a mold lined with sand to prevent sticking, producing a matte-textured surface.

## waterstruck brick

Brick formed in the soft-mud process with a mold lubricated with water to prevent sticking, producing a smooth, dense surface.

## stiff-mud process

The process of forming brick and structural tile by extruding stiff but plastic clay having a moisture content of 12% to 15% through a die and cutting the extrusion to length with wires before firing.

## dry-press process

The process of forming brick by molding relatively dry clay having a moisture content of 5% to 7% under high pressure, resulting in sharp-edged, smooth-surfaced bricks.

## kiln

A furnace or oven for burning, baking, or drying something, esp. one for firing pottery, baking bricks, or drying timber.

## flashing

Firing brick units alternately with too much or too little air to vary their face color.

## cull

A brick or timber rejected as being of inferior quality.

## brick grade

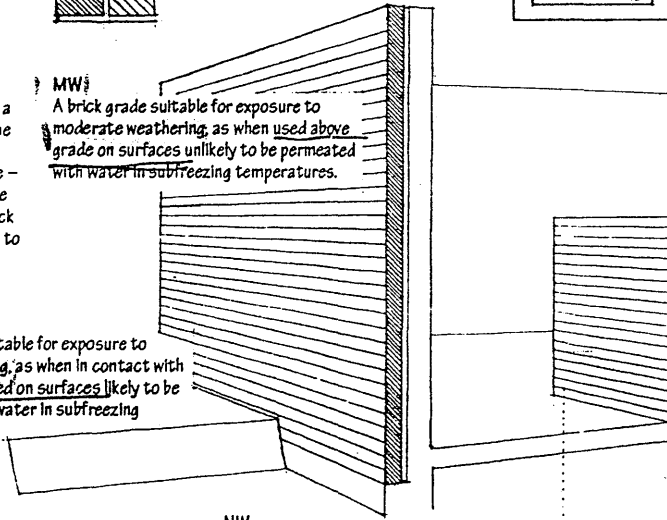
A designation indicating the durability of a brick unit when exposed to weathering. The U.S. is divided into three weathering regions - severe, moderate, and negligible - according to annual winter rainfall and the annual number of freezing-cycle days. Brick is graded for use in each region according to compressive strength, maximum water absorption, and maximum saturation coefficient.

## MW

A brick grade suitable for exposure to moderate weathering, as when used above grade on surfaces unlikely to be permeated with water in subfreezing temperatures.

## SW

A brick grade suitable for exposure to severe weathering, as when in contact with the ground or used on surfaces likely to be permeated with water in subfreezing temperatures.



## NW

A brick grade suitable for exposure to negligible weathering as when used as a backup or in interior masonry.

## absorption

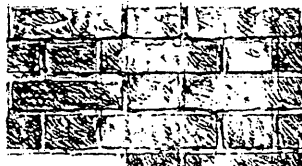
The weight of water absorbed by a clay masonry unit when immersed in either cold or boiling water for a stated length of time, expressed as a percentage of the weight of the dry unit.

## saturation coefficient

The ratio of the weight of water absorbed by a clay masonry unit immersed in cold water to the weight absorbed when immersed in boiling water, indicating the probable resistance of the brick to the action of freezing and thawing.

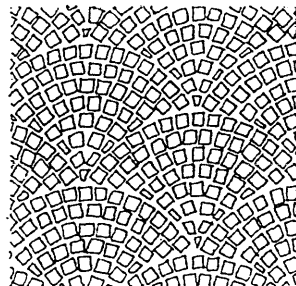
## suction

The weight of water absorbed by a clay masonry unit when partially immersed for one minute, expressed in grams or ounces per minute. Also called initial rate of absorption.



## efflorescence

A white, powdery deposit that forms on an exposed masonry or concrete surface, caused by the leaching and crystallization of soluble salts from within the material.



## firebrick

A brick made of fire clay and used for lining furnaces and fireplaces.

## fire clay

A refractory clay used in the making of firebricks, crucibles, and other objects exposed to high temperatures.

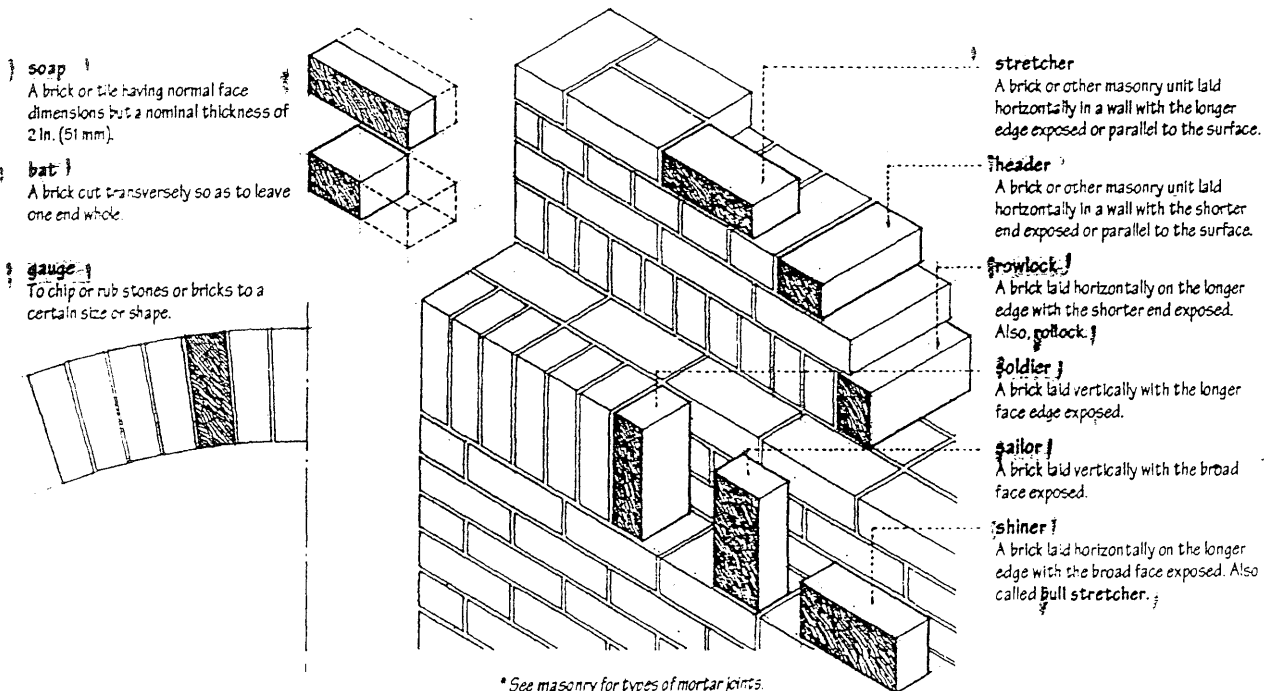
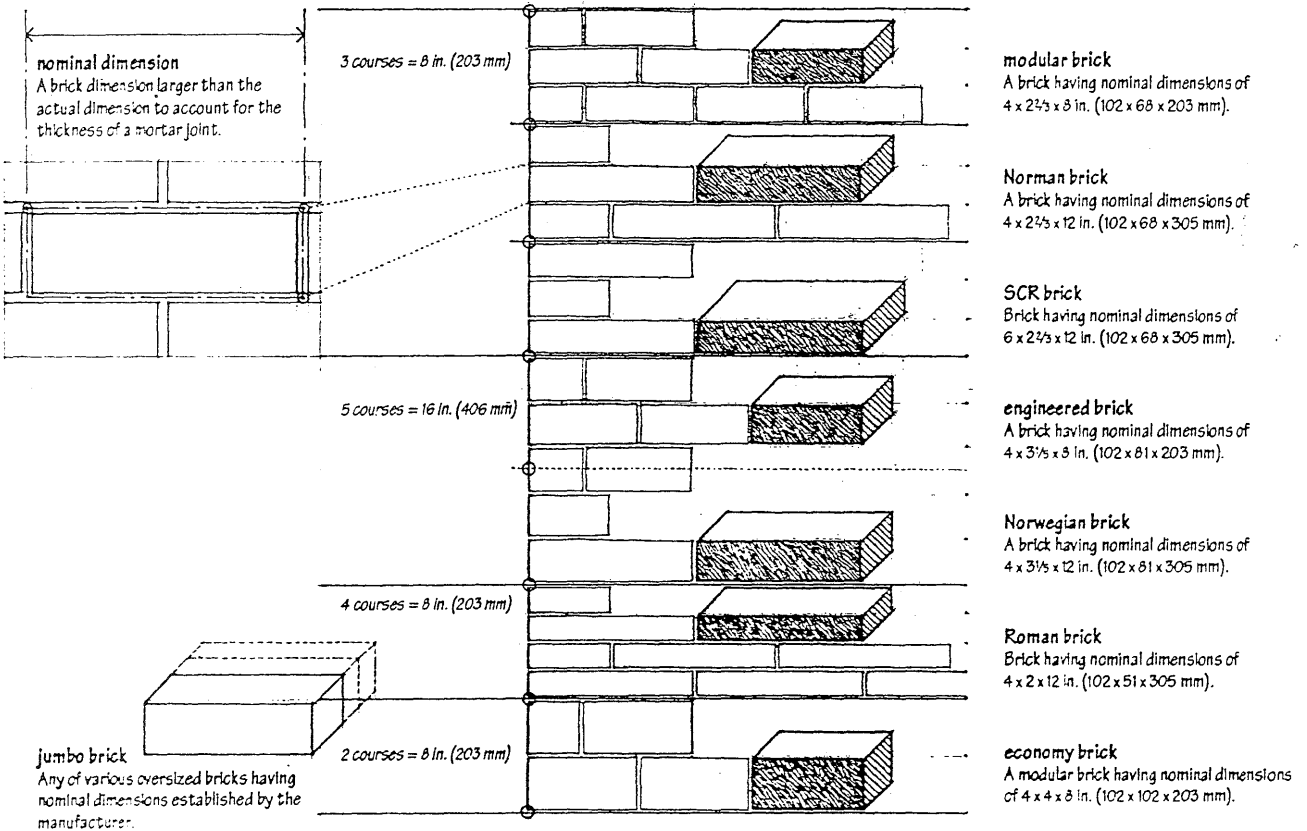
## refractory

A material having the ability to retain its physical shape and chemical identity when subjected to high temperatures.

## clinker

A dense, hard-burned brick used esp. for paving.





# BRICK

## brickwork

Brick construction, esp. the art of bonding bricks effectively.

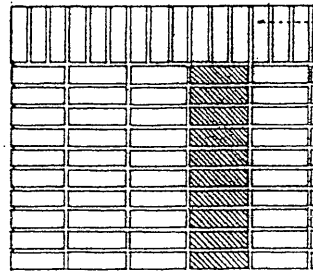
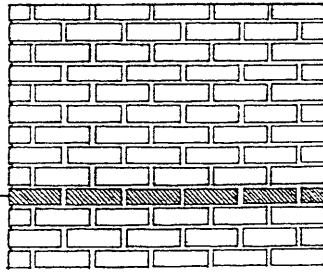
## bond

Any of various arrangements of masonry units having a regular, recognizable, usually overlapping pattern to increase the strength and enhance the appearance of the construction.

## running bond

A brickwork or masonry bond composed of overlapping stretchers. Also called

## stretcher bond



## soldier course

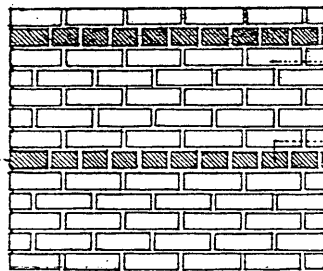
A continuous course of soldiers in brickwork.

## stack bond

A brickwork or masonry bond having successive courses of stretchers with all head joints aligned vertically. Also, stacked bond.

## common bond

A brickwork bond having a course of headers between every five or six courses of stretchers. Also called American bond.



## stretching course

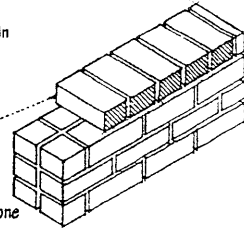
A continuous course of stretchers in brickwork.

## heading course

A continuous course of headers in brickwork.

## bond course

A continuous course of headers or bondstones overlapping more than one wythe of masonry.

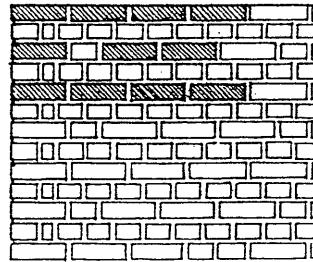
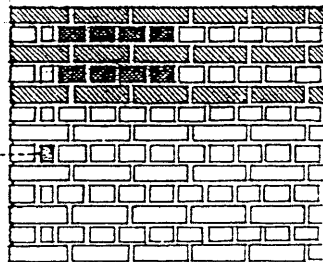


## closer

A masonry unit specially formed or cut to finish a course or complete the bond at the corner of a wall. Also, closure.

## English bond

A brickwork bond having alternate courses of headers and stretchers in which the headers are centered on stretchers and the joints between stretchers line up vertically in all courses.



## English cross bond

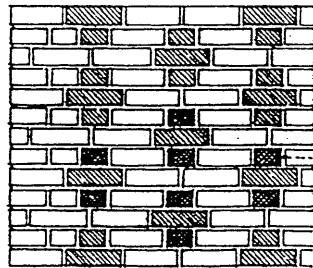
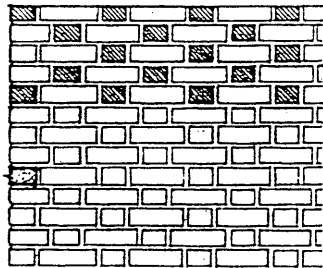
A modified English bond in which the head joints in the stretching courses are offset by half the length of a stretcher. Also called Dutch bond.

## queen closer

A brick of half the normal width, used for completing a course or for spacing regular bricks. Also, queen closure.

## Flemish bond

A brickwork bond having alternating headers and stretchers in each course, each header being centered above and below a stretcher.



## Flemish cross bond

A modified Flemish bond having courses of alternate headers and stretchers alternating with stretching courses.

## king closer

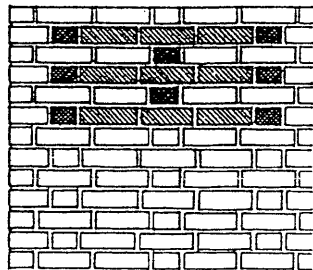
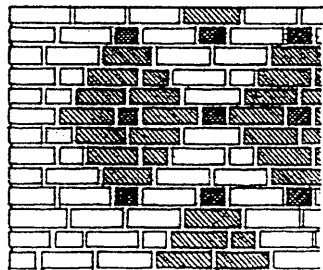
A three-quarter brick for finishing a course or for spacing regular bricks. Also, king closure.

## flare header

A brick having a darker end exposed as a header in patterned brickwork.

## Flemish diagonal bond

A form of Flemish cross bond in which the courses are offset to form a diamond pattern.



## garden-wall bond

A brickwork bond for tightly loaded boundary walls, having a sequence of a header and three stretchers in each course, with each header being centered over a header in alternate courses.

A relatively permanent enclosed structure constructed over a plot of land for habitable use.

A building is a shelter from rain, sun, and wind. This implies a Roof, and Walls to support it. If the walls entirely enclose the space within, there are Doorways for access, and Windows for light. Roofs and walls, doors and windows are the essential features of buildings.

Roofs may be flat, sloping, or curved. A roof with one slope is called a Lean-to. When two sloping roofs rest upon parallel walls and lean against one another, they meet in a horizontal ridge at the top, and form a Gable at each end. If two walls make a projecting angle, their roofs intersect in an inclined line called a Hip. If the walls meet in a reentering angle, the inclined line of intersection is called a Valley. Circular walls carry conical or domical roofs.

If there is more than one story, the flat roof of the lower story becomes the Floor of the story above. If the roof extends beyond the wall that supports it, the projection is called the Eaves. If the wall also projects to support the extension of the roof, the projection is called a Cornice. The principal member of a cornice, which projects like a shelf and crowns the wall, is called a Corona.

Walls are generally made wider just at the bottom so as to get a better bearing on the ground. This projection is the Base. A similar projection at the top is called a Cap or, if it projects much, a Cornice, as has been said. A low wall is called a Parapet. A short piece of wall about as long as it is thick is called a Post, and if it supports something, a Pedestal; the part between its cap and base is then the Die. A tall post is called a Pier. If it is square, and a Column if it is round. Caps of piers and columns are called Capitals, and the part between the cap and the base, the shaft. The flat upper member of a capital is called the Abacus.

A beam that spans the space between two piers or columns or between a pier or column and a wall is called an Architrave, or Epistyle. Above it, between the architrave and the cornice, there is generally a little strip of wall called the Frieze. Architrave, frieze, and cornice constitute the Entablature. A series of columns is called a Colonnade. The spaces between piers or columns are sometimes spanned by Arches, a series of which is called an Arcade.

The space between two parallel walls is sometimes covered by a sort of continuous arch called a Vault, instead of by a floor or roof.

The Wall, the Pier, and the Column, with or without the pedestal, constitute the chief supporting members; the Frieze and Cornice, with the roof that rests upon them, constitute the chief part of the load they carry. The Architrave, the Arches, and the Spandrels form part of the load relative to what is below them, but are supporting members relative to what is above them.

Besides being valuable as a shelter, a building may be in itself a noble and delightful object, and architects are builders who, by giving a building good proportions and fine details, and by employing beautiful materials, make it valuable on its own account, independently of its uses.

—William Robert Ware  
The American Vignola

**superstructure**  
The vertical extension of a building or other construction above the foundation.

**shell**  
The exterior framework or walls and roof of a building.

Labels in diagram:  
• roof  
• ceiling  
• room  
• wall  
• window  
• door  
• floor

• mechanical systems

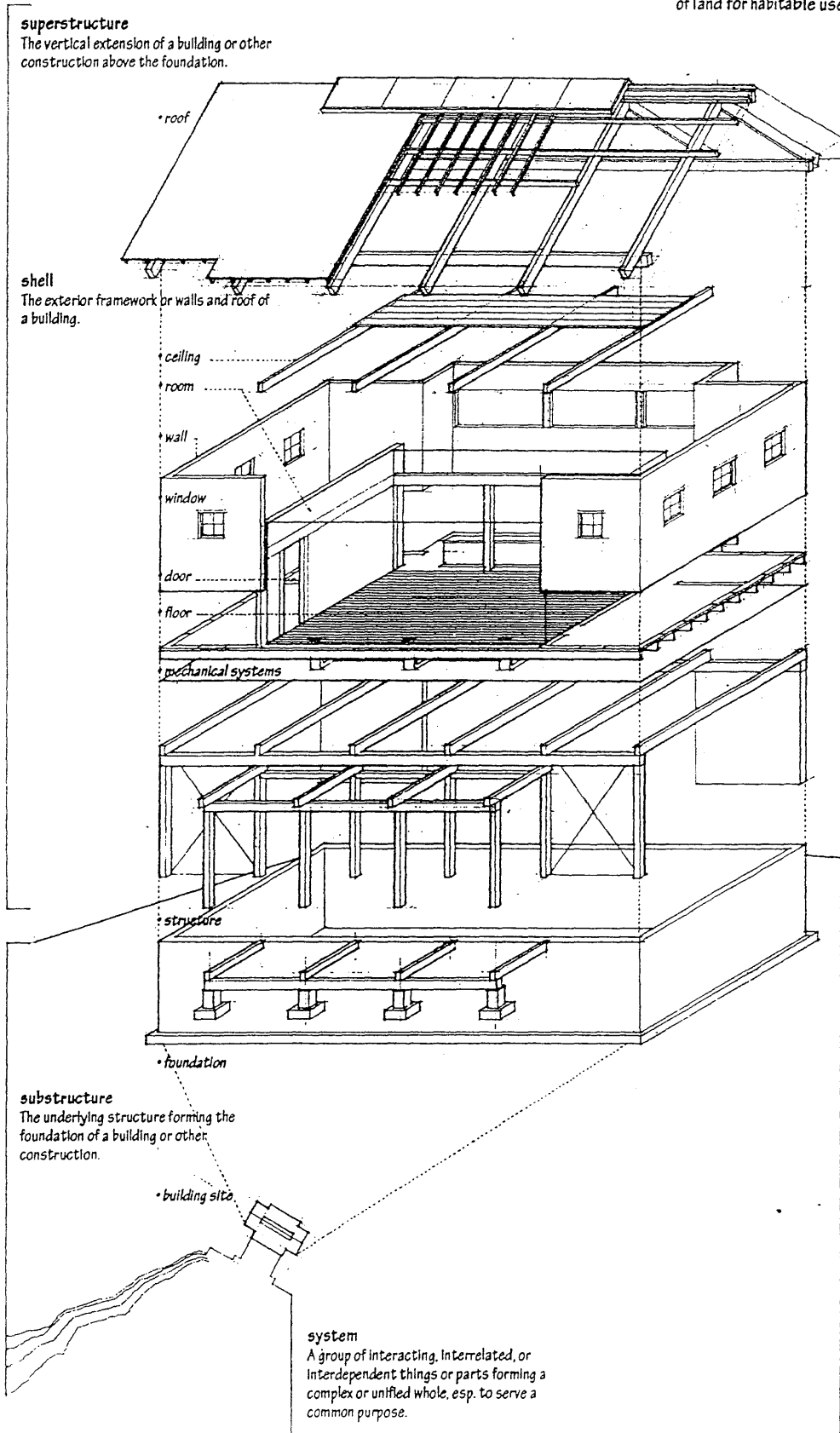
• structure

• foundation

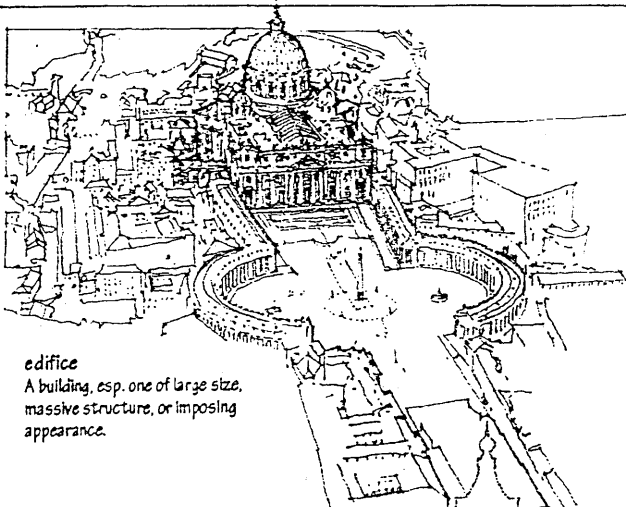
**substructure**  
The underlying structure forming the foundation of a building or other construction.

• building site

**system**  
A group of interacting, interrelated, or interdependent things or parts forming a complex or unified whole, esp. to serve a common purpose.

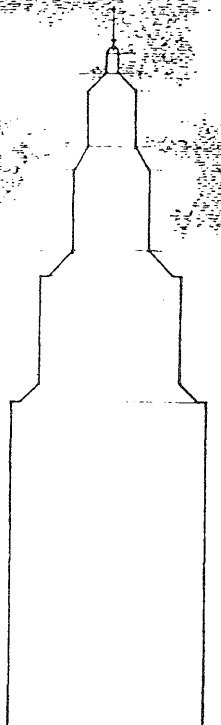


# BUILDING



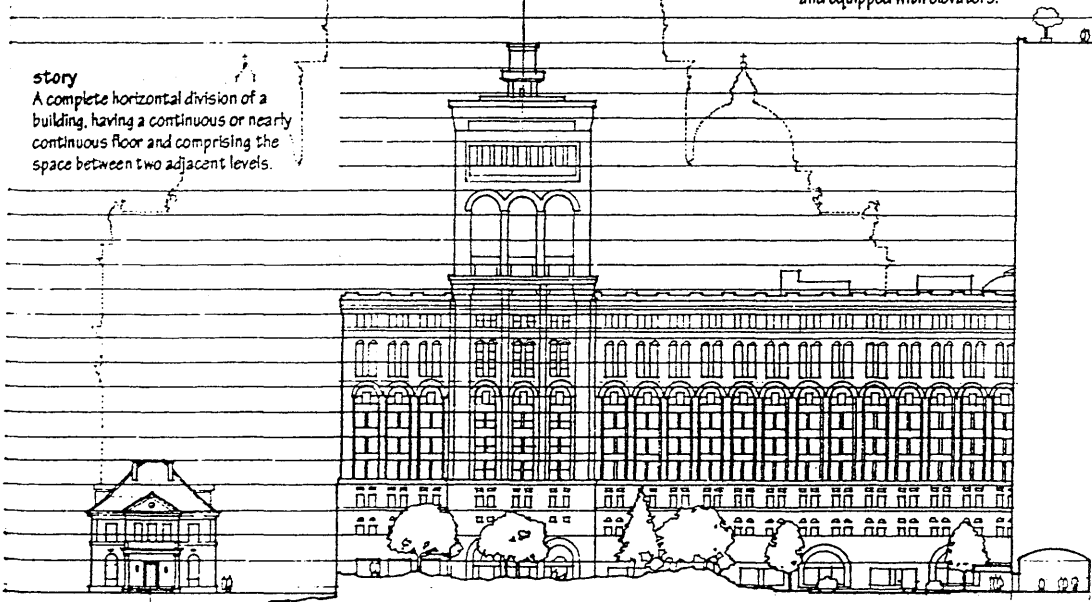
**edifice**  
A building, esp. one of large size, massive structure, or imposing appearance.

**skyscraper**  
A building of exceptional height and many stories, supported by a steel or concrete framework from which the walls are suspended.



**high-rise**  
Describing a building having a comparatively large number of stories and equipped with elevators.

**story**  
A complete horizontal division of a building, having a continuous or nearly continuous floor and comprising the space between two adjacent levels.

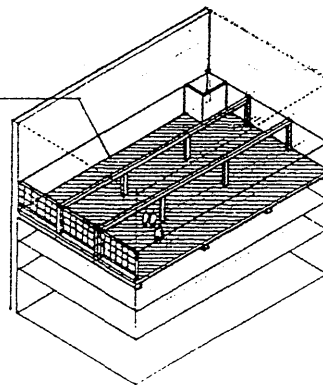


**low-rise**  
Describing a building having one, two, or three stories and usually no elevator.

**mid-rise**  
Describing a building having a moderately large number of stories, usually 5 to 10, and equipped with elevators.

**loft**  
One of the upper floors of a warehouse or factory, typically unpartitioned and sometimes converted or adapted to other uses, as living quarters, artists' studios, or exhibition galleries.

**loft building**  
A building having several floors with large areas of unobstructed space, originally rented out for light industrial purposes and now frequently converted to residential occupancy.



**attic**  
A room or space directly under the roof of a building, esp. a house.

**half story**  
A usable living space within a sloping roof, usually having dormer windows for lighting.

**crawl space**  
An area in a building having a clearance less than human height, but accessible by crawling, esp. such a space below the first floor that is enclosed by foundation walls.

**cellar**  
A room or set of rooms, for the storage of food, fuel, or the like, wholly or partly underground and usually beneath a building.

**cyclone cellar**  
A cellar or other underground place for shelter during violent storms, as cyclones, tornadoes, or hurricanes. Also called storm cellar.

**bulkhead**  
A horizontal or inclined door over a stairway giving access to a cellar.

**floor**  
A continuous supporting surface extending horizontally throughout a building, having a number of rooms and constituting one level in the structure.

**mezzanine**  
A low or partial story between two main stories of a building, esp. one that projects as a balcony and forms a composition with the story beneath it.

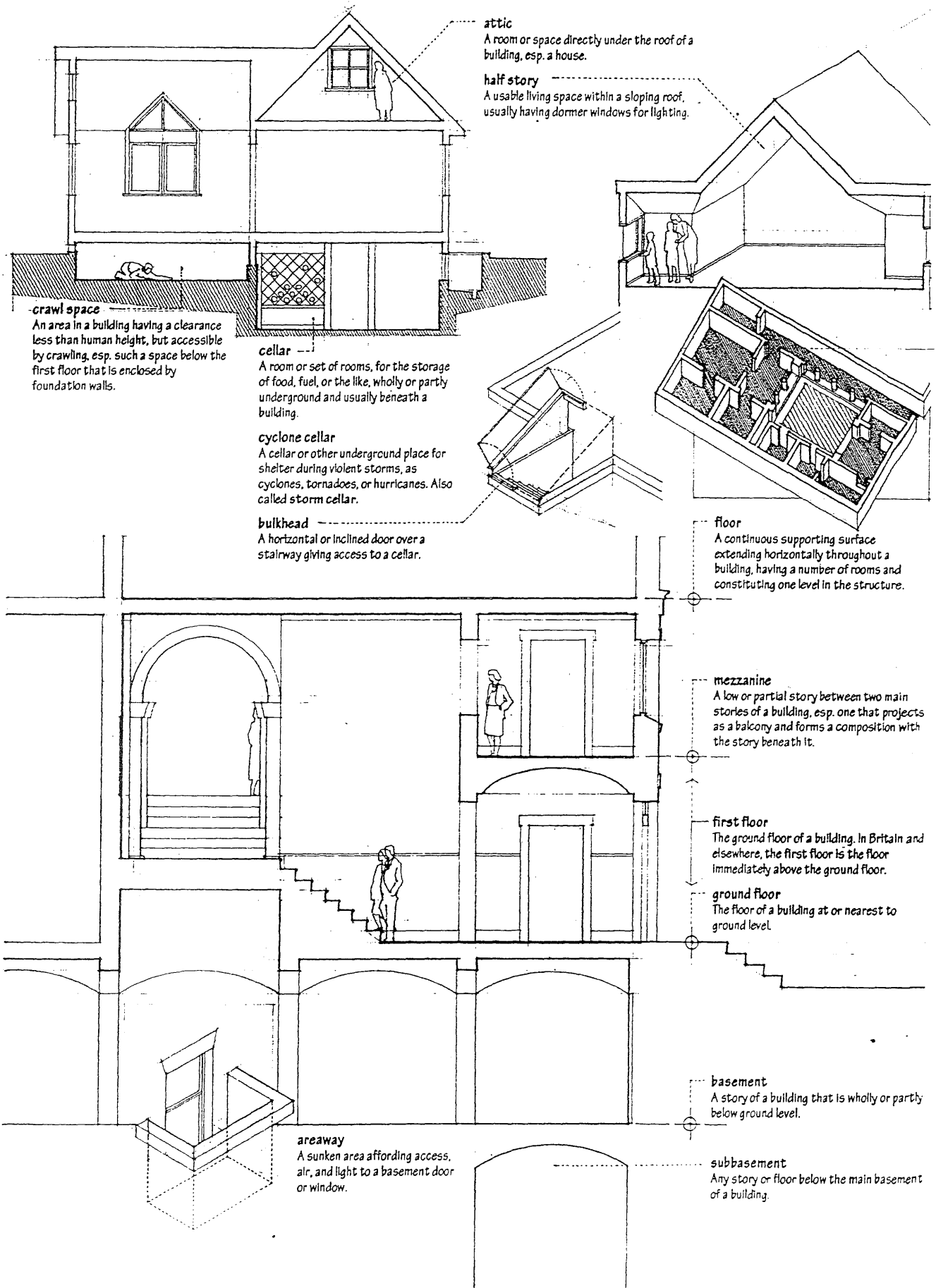
**first floor**  
The ground floor of a building. In Britain and elsewhere, the first floor is the floor immediately above the ground floor.

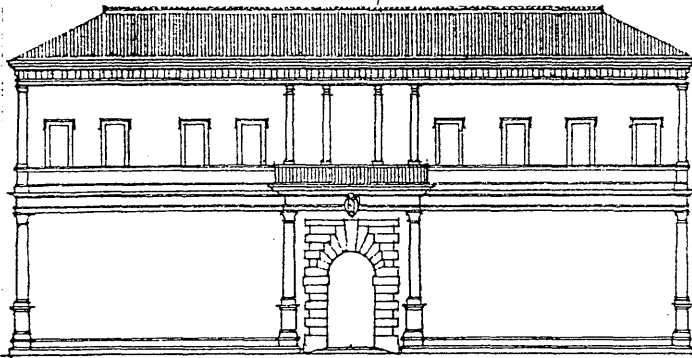
**ground floor**  
The floor of a building at or nearest to ground level.

**basement**  
A story of a building that is wholly or partly below ground level.

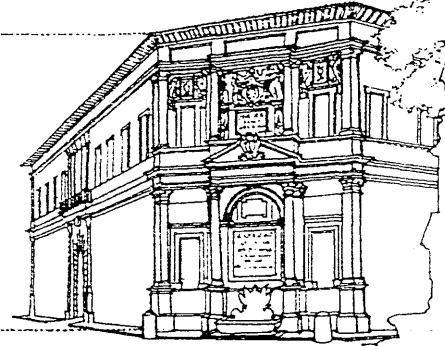
**areaway**  
A sunken area affording access, air, and light to a basement door or window.

**subbasement**  
Any story or floor below the main basement of a building.

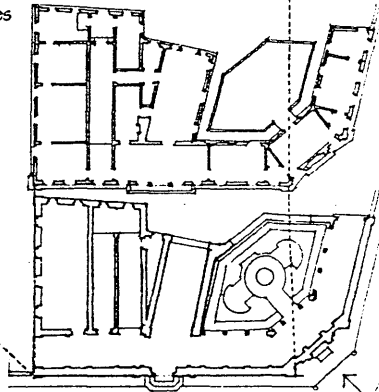




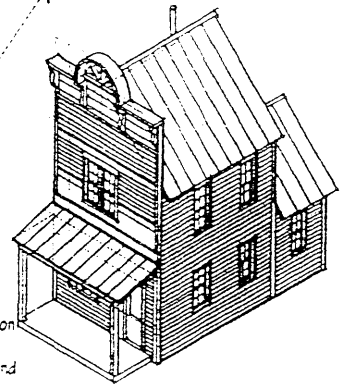
**facade**  
The front of a building or any of its sides facing a public way or space, esp. one distinguished by its architectural treatment.



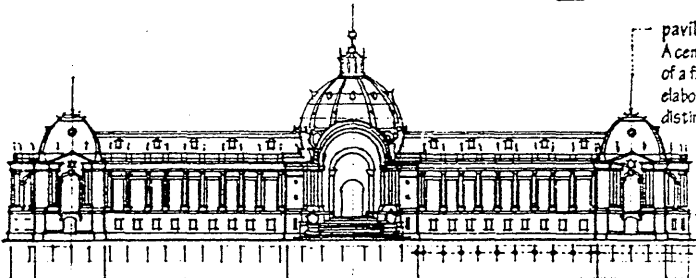
**frontispiece**  
A principal facade, or a part or feature of a facade, often treated as a separate element of the design and highlighted by ornamentation.



**pavilion**  
A central or flanking projecting subdivision of a facade, usually accented by more elaborate decoration or greater height and distinction of skyline.



**false front**  
A facade falsifying the size or importance of a building.

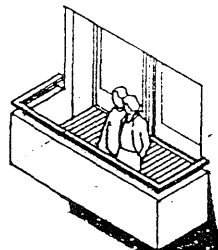


**story**  
A major horizontal architectural division, as of a facade or the wall of a nave.

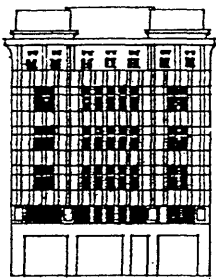
**bay**  
Any of a number of principal divisions of a wall, roof, or other part of a building marked off by vertical or transverse supports.

**blindstory**  
A major horizontal division of a wall having no exterior windows.

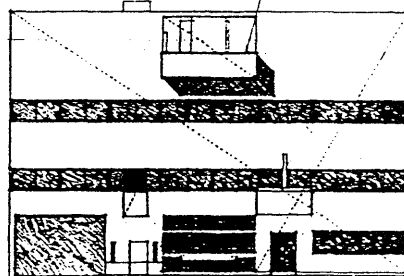
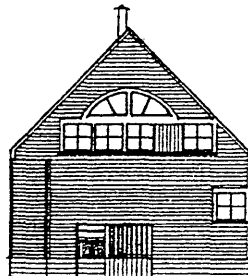
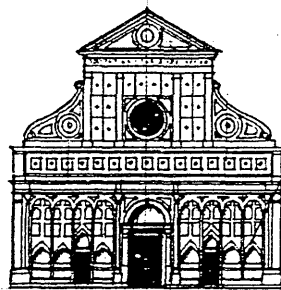
**blind**  
Describing a recess in a wall having the appearance of a window (blind window) or door (blind door). Inserted to complete a series of windows or to provide symmetry of design.

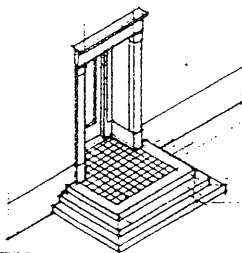


**balcony**  
An elevated platform projecting from the wall of a building and enclosed by a railing or parapet.



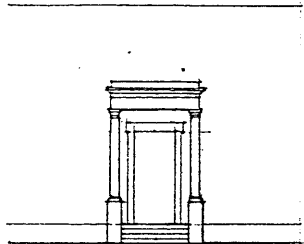
**fenestration**  
The design, proportioning, and disposition of windows and other exterior openings of a building.





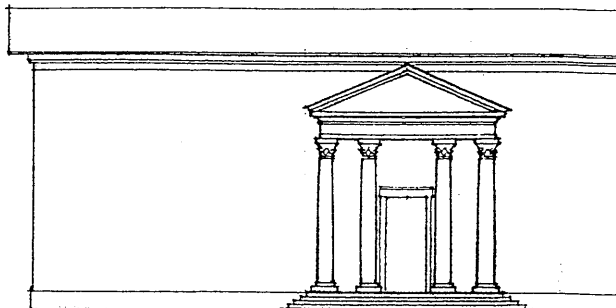
**stoop**

A raised platform, approached by steps and sometimes having a roof, at the entrance of a house.



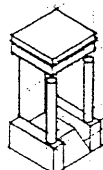
**porch**

An exterior appendage to a building, forming a covered approach or vestibule to a doorway.



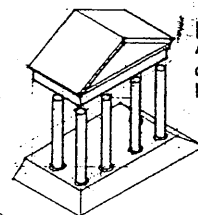
**portico**

A porch having a roof supported by columns, often leading to the entrance of a building.



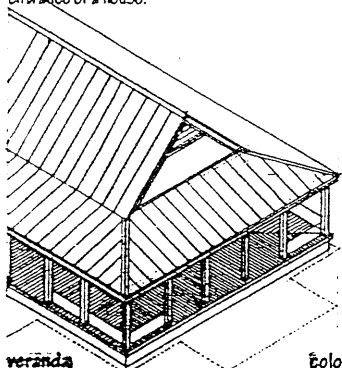
**colonnade**

A series of regularly spaced columns supporting an entablature and usually one side of a roof structure.



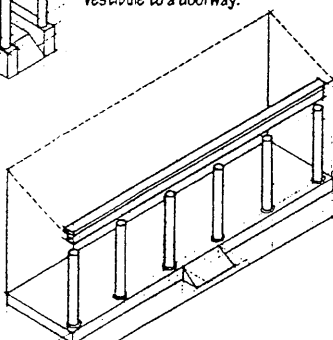
**forecourt**

A courtyard before the entrance to a building or a group of buildings.



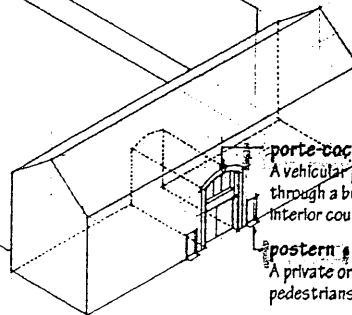
**veranda**

A large, open porch, usually roofed and partly enclosed, as by a railing, often extending across the front and sides of a house. Also *verandah*.



**lanai**

A veranda, esp. a fully furnished one used as a living room.

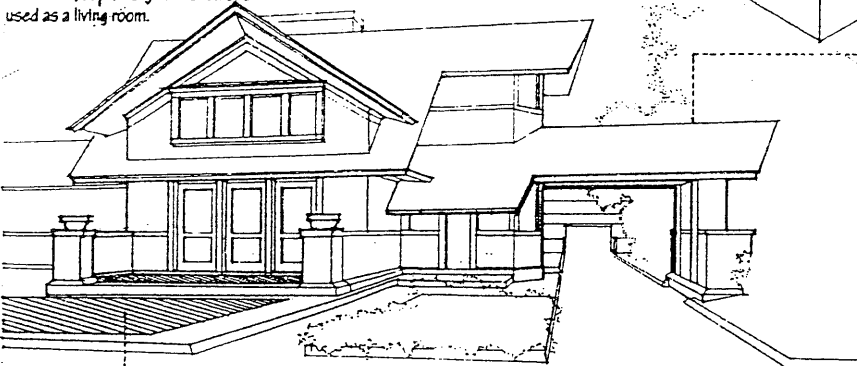


**porte-cochère**

A vehicular passageway leading through a building or screen wall into an interior courtyard.

**postern**

A private or side entrance, as one for pedestrians next to a porte-cochère.

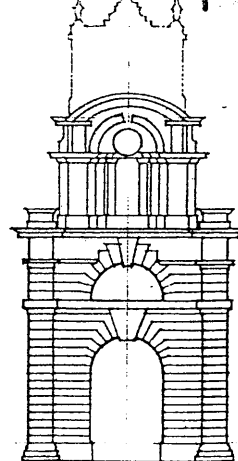


**terrace**

An open, often paved area connected to a house or building and serving as an outdoor living area.

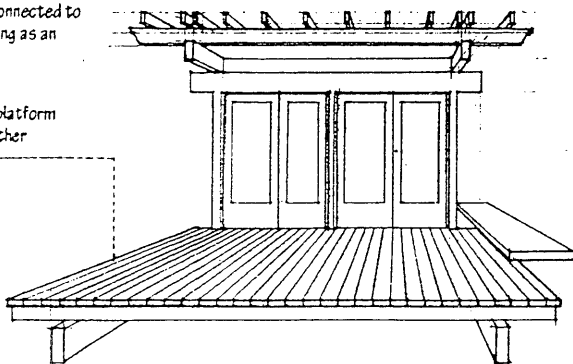
**porte-cochère**

A porch roof projecting over a driveway at the entrance to a building and sheltering those getting in or out of vehicles. Also called *carriage porch*.



**portal**

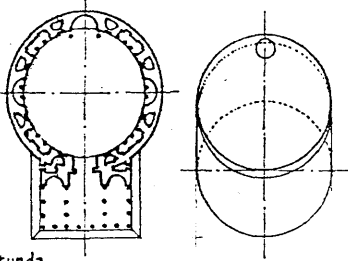
A doorway, gate, or entrance, esp. an imposing one emphasized by size and stately architectural treatment.



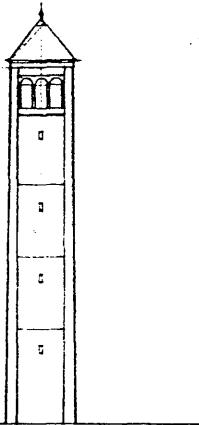
**deck**

An open, unroofed porch or platform extending from a house or other building.





**rotunda**  
A round, domed building, or a large and high circular space in such a building, esp. one surmounted by a dome.



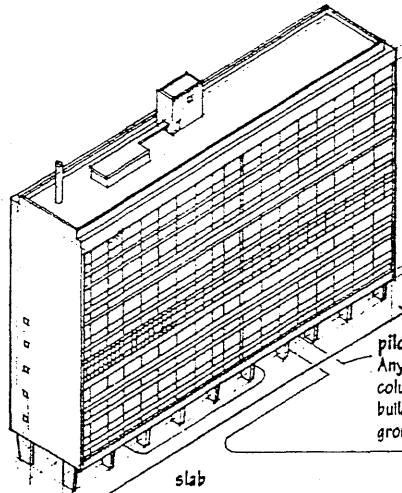
**tower**  
A building or structure high in proportion to its lateral dimensions, either standing alone or forming part of a larger building.

**block**  
A large building divided into a number of separate apartments, offices, or shops.

**loggia**  
A colonnaded or arcaded space within the body of a building but open to the air on one side, often at an upper story overlooking an open court.

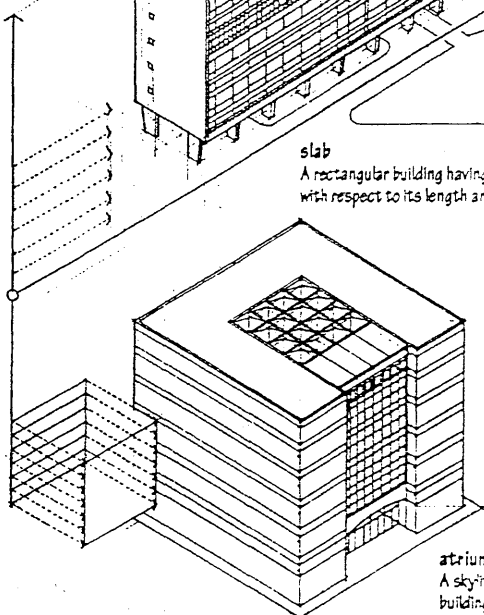
**piano nobile**  
The principal story of a large building, as a palace or villa, with formal reception and dining rooms, usually one flight above the ground floor.

**cortile**  
A large or principal courtyard of an Italian palazzo.

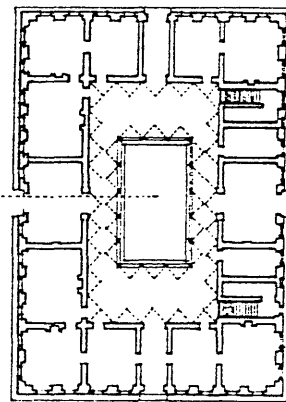
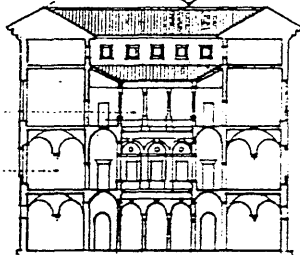


**piloti**  
Any of a series of columns supporting a building above an open ground level.

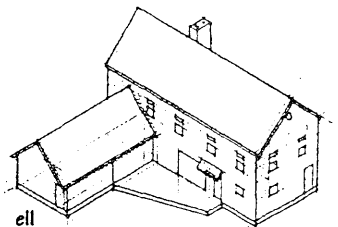
**slab**  
A rectangular building having little width with respect to its length and height.



**atrium**  
A sky-lit, central court in a building, esp. a large interior one having a glass roof and surrounded by several stories of galleries.

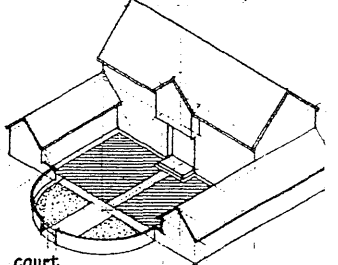


**palazzo**  
A large, imposing public building or private residence, esp. in Italy.

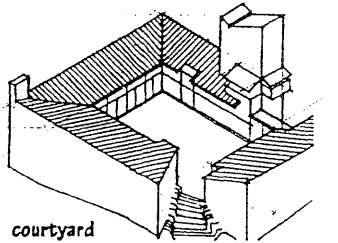


**ell**  
A wing at right angles to the length of a building. Also, et.

**wing**  
A part of a building projecting from and subordinate to a central or main part.

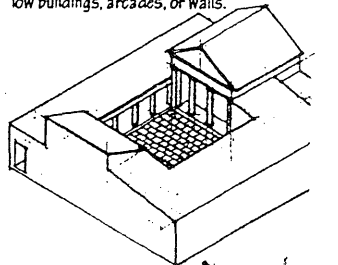


**court**  
An area open to the sky and mostly or entirely surrounded by walls or buildings.

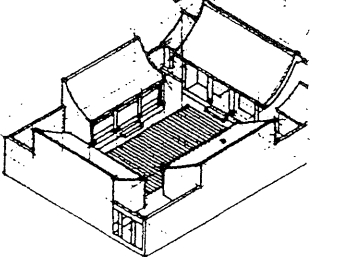


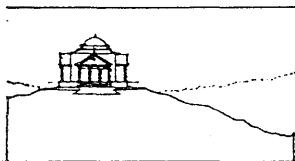
**courtyard**  
A court adjacent to or within a building, esp. one enclosed on all four sides.

**patio**  
A courtyard, esp. of a house, enclosed by low buildings, arcades, or walls.

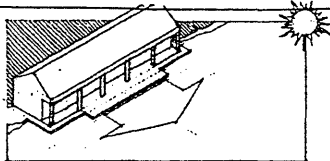


**atrium**  
An open, skylit court around which a house or building is built.





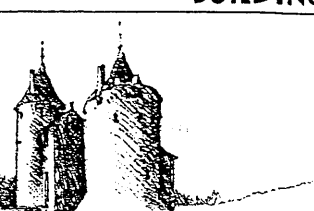
**claim**  
To assert or demand recognition or possession.



**front**  
To face in a specific direction or look out upon.

**orientation**

The position of a building on a site in relation to true north, to points on the compass, to a specific place or feature, or to local conditions of sunlight, wind, and drainage.



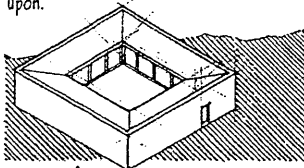
**folly**  
A whimsical or extravagant structure built to serve as a conversation piece, lend interest to a view, or commemorate a person or event.



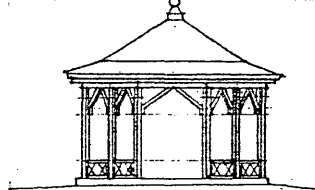
**pavilion**  
A small, often ornamental building in a garden.



**merge**  
To combine, blend, or unite gradually by stages so as to blur identity or distinctions.



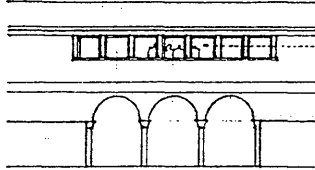
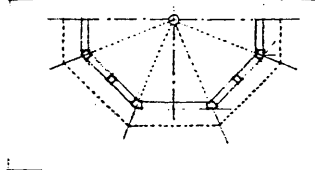
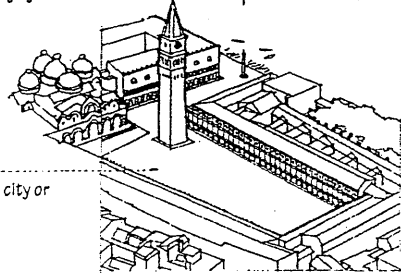
**surround**  
To enclose or encompass on all sides.



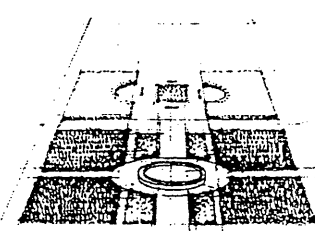
**gazebo**  
A freestanding roofed structure, usually open on the sides, affording shade and rest in a garden or park.

**plaza**  
A public square or open space in a city or town.

**piazza**  
An open square or public place in a city or town, esp. in Italy.



**bevedere**  
A building, or architectural feature of a building, designed and situated to look out upon a pleasing scene.

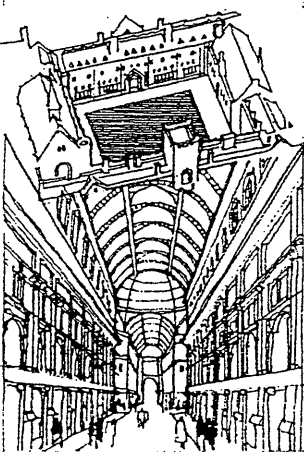


**topiary**  
Clipped or trimmed into ornamental and fantastic shapes, or the work or art of such clipping.



**parterre**  
An ornamental arrangement of flower beds of different shapes and sizes.

**quadrangle**  
A square or quadrangular space or court surrounded by a building or buildings, as on a college campus. Also called quad.



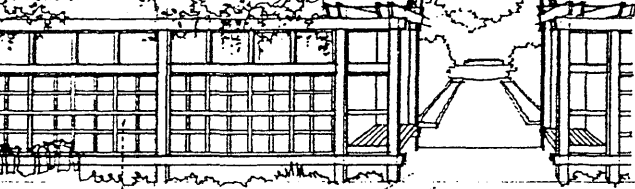
**galleria**  
A spacious promenade, court, or indoor mall, usually having a vaulted roof and lined with commercial establishments.

**promenade**  
An area used for a stroll or walk, esp. in a public place, as for pleasure or display.

**allée**  
French term for a broad walk planted with trees.

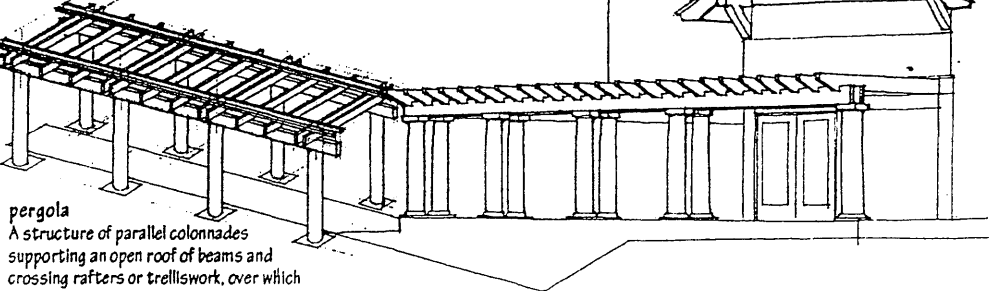


**arbor**  
A shelter of shrubs and branches or of latticework intertwined with climbing vines and flowers.



**trellis**  
A frame supporting open latticework, used as a screen or a support for growing vines or plants.

**lattice**  
A structure of crossed strips arranged to form a regular pattern of open spaces.

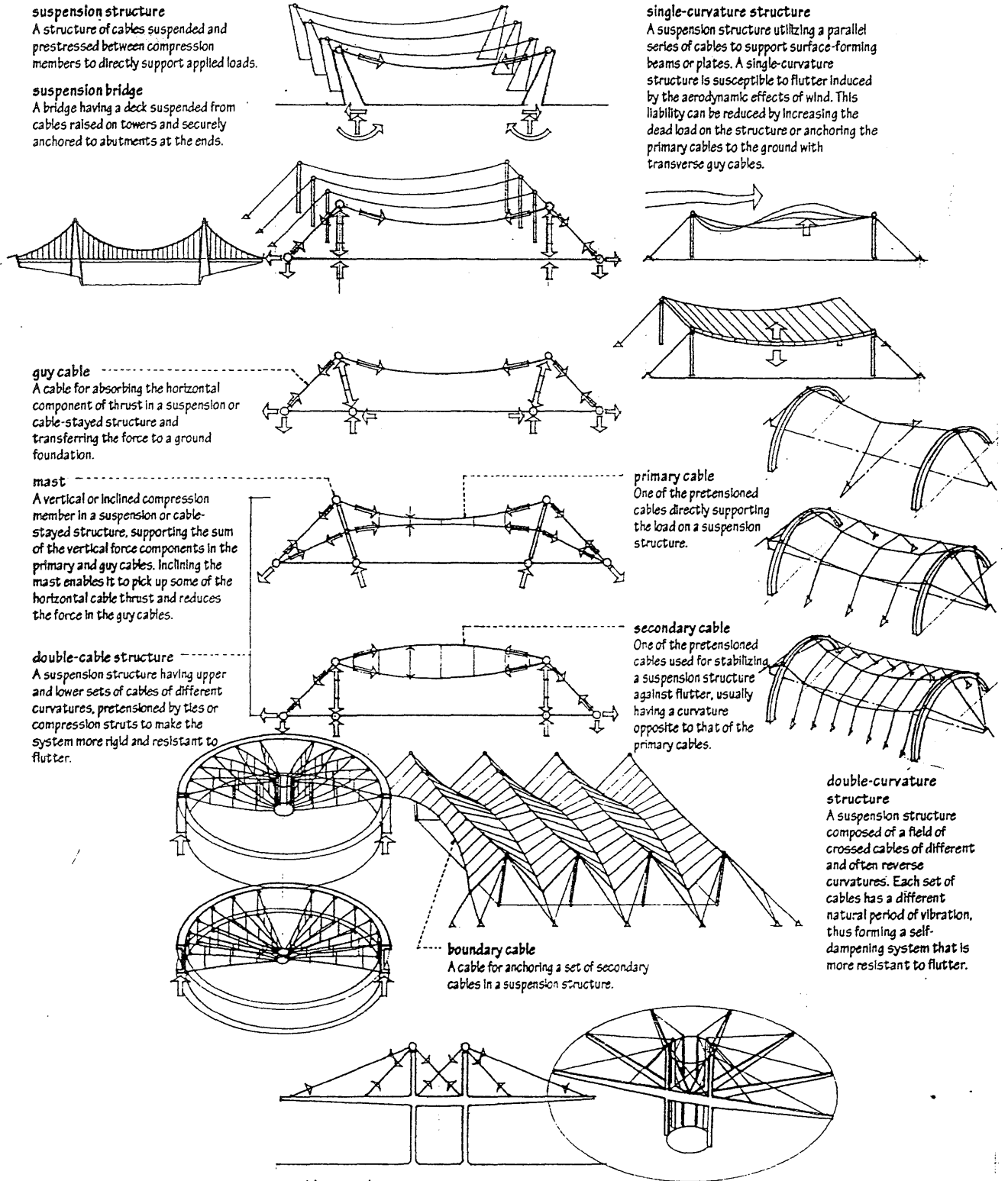


**pergola**  
A structure of parallel colonnades supporting an open roof of beams and crossing rafters or trelliswork, over which climbing plants are trained to grow.

**suspension structure**  
A structure of cables suspended and prestressed between compression members to directly support applied loads.

**suspension bridge**  
A bridge having a deck suspended from cables raised on towers and securely anchored to abutments at the ends.

**single-curvature structure**  
A suspension structure utilizing a parallel series of cables to support surface-forming beams or plates. A single-curvature structure is susceptible to flutter induced by the aerodynamic effects of wind. This liability can be reduced by increasing the dead load on the structure or anchoring the primary cables to the ground with transverse guy cables.



**guy cable**  
A cable for absorbing the horizontal component of thrust in a suspension or cable-stayed structure and transferring the force to a ground foundation.

**mast**  
A vertical or inclined compression member in a suspension or cable-stayed structure, supporting the sum of the vertical force components in the primary and guy cables. Inclining the mast enables it to pick up some of the horizontal cable thrust and reduces the force in the guy cables.

**double-cable structure**  
A suspension structure having upper and lower sets of cables of different curvatures, pretensioned by ties or compression struts to make the system more rigid and resistant to flutter.

**primary cable**  
One of the pretensioned cables directly supporting the load on a suspension structure.

**secondary cable**  
One of the pretensioned cables used for stabilizing a suspension structure against flutter, usually having a curvature opposite to that of the primary cables.

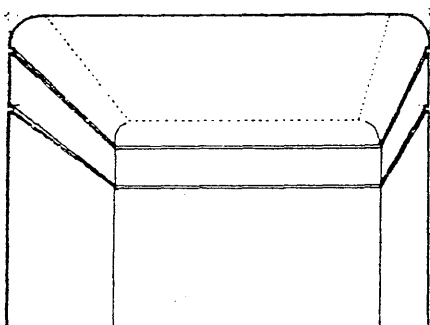
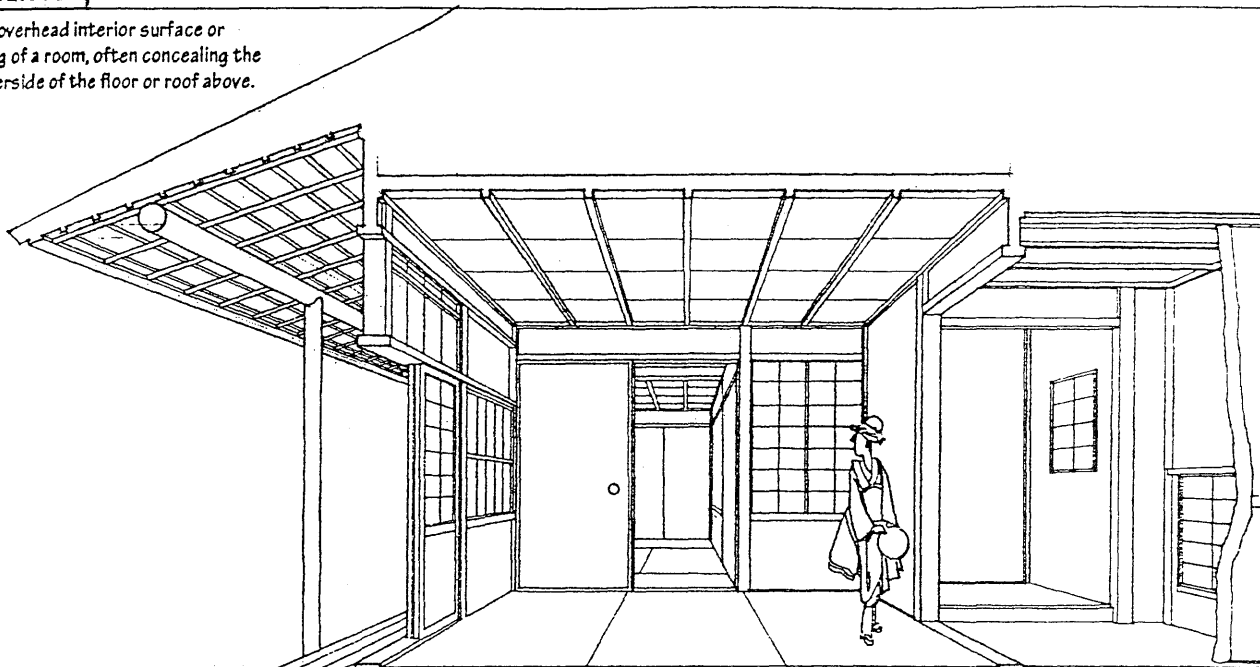
**double-curvature structure**  
A suspension structure composed of a field of crossed cables of different and often reverse curvatures. Each set of cables has a different natural period of vibration, thus forming a self-dampening system that is more resistant to flutter.

**boundary cable**  
A cable for anchoring a set of secondary cables in a suspension structure.

**cable-stayed structure**  
A structure having vertical or inclined masts from which cables extend to support horizontally spanning members arranged in a parallel or radial pattern.

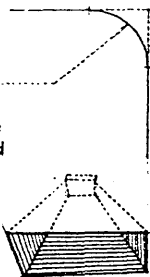
**CEILING**

The overhead interior surface or lining of a room, often concealing the underside of the floor or roof above.

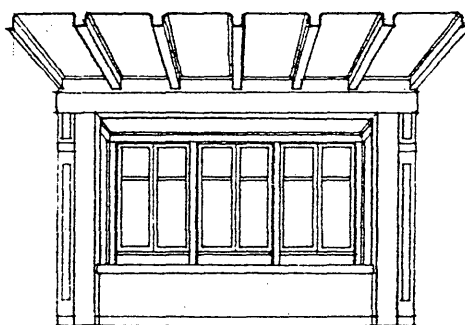


**cove ceiling**  
A ceiling having a cove. Also, coved ceiling.

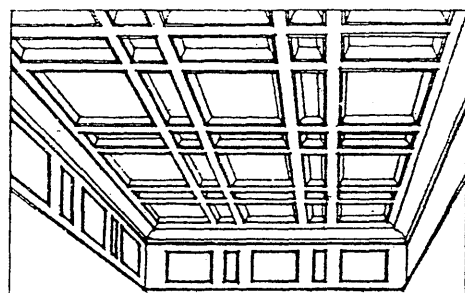
**cove**  
A concave surface forming part of a ceiling at its edge so as to eliminate the usual interior angle between the wall and the ceiling.



**camp ceiling**  
A ceiling having the form of a truncated pyramid.

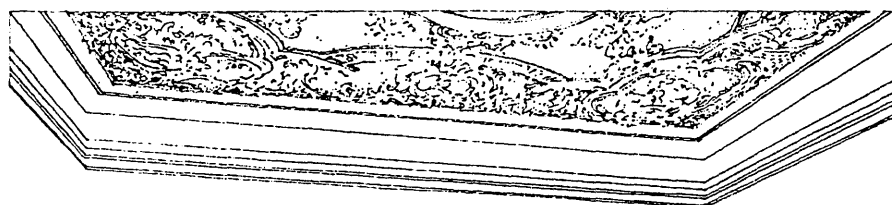
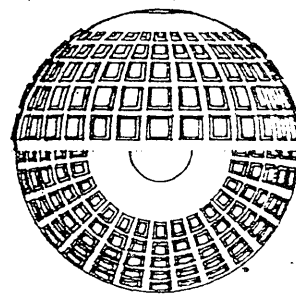


**beam ceiling**  
The underside of a floor showing the supporting beams and finished to form a ceiling.



**coffer**  
One of a number of recessed, usually square or octagonal panels in a ceiling, soffit, or vault. Also called caisson, lacunar.

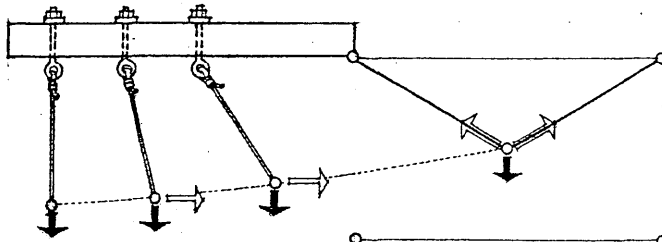
**lacunar**  
A ceiling, soffit, or vault adorned with a pattern of recessed panels.



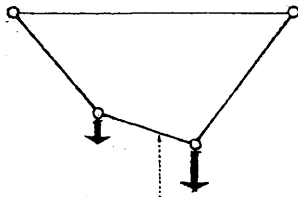
**plafond**  
A flat or vaulted ceiling of decorative character.

# CABLE STRUCTURE

A structural system utilizing the cable as the principal means of support.



**cable**  
A flexible structural member, as wire rope or metal chain, having high tensile strength but offering no resistance to compression or bending.

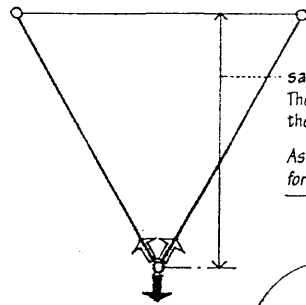
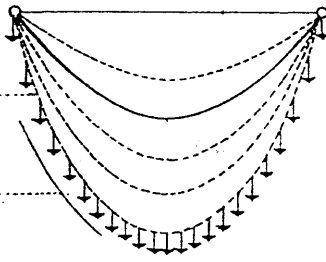
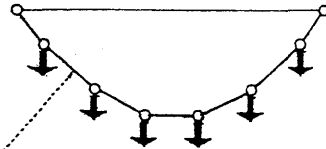
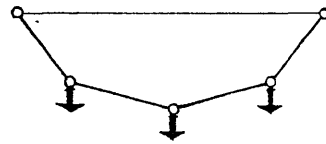
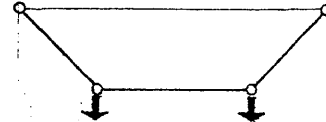


**funicular shape**  
The shape assumed by a freely deforming cable in direct response to the magnitude and location of external forces. A cable always adapts its shape so that it is in pure tension under the action of an applied load.

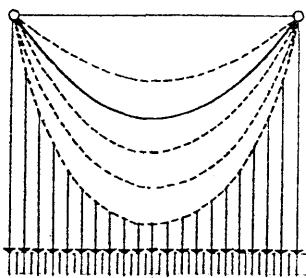
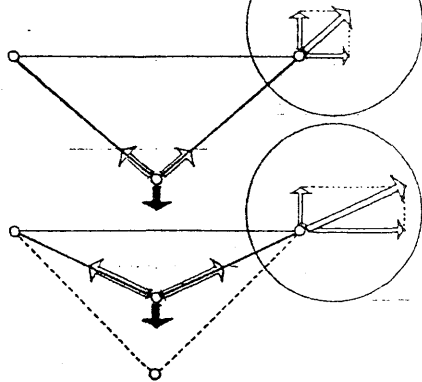
**funicular polygon**  
The shape assumed by a freely deforming cable in direct response to a set of concentrated loads.

**funicular curve**  
The shape assumed by a freely deforming cable in direct response to a uniformly distributed load.

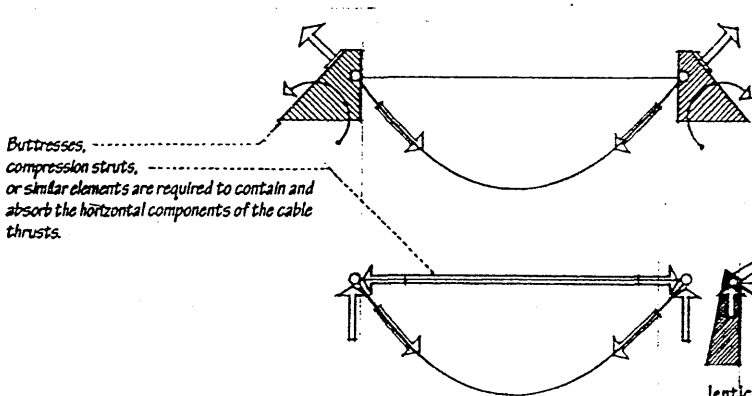
**catenary**  
The curve assumed by a perfectly flexible, uniform cable suspended freely from two points not in the same vertical line. For a load that is uniformly distributed in a horizontal projection, the curve approaches that of a parabola.



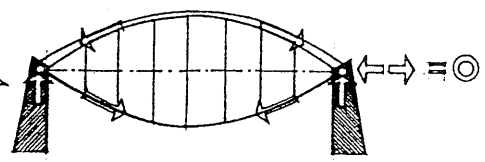
**sag**  
The vertical distance from the supports to the lowest point of a cable structure.  
As the sag of a cable increases, the internal forces developed in the cable decrease.



**funicular structure**  
A structure shaped to carry or support a given loading by either axial tension or compression. For any given loading condition, there is only one general funicular shape. If the loading pattern changes, bending is induced in the structure.



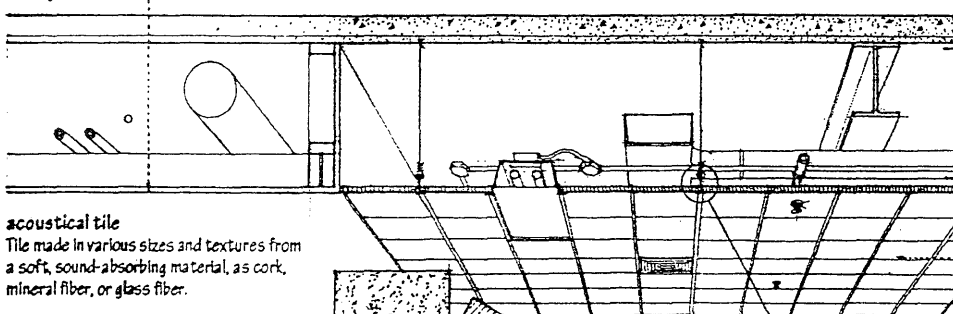
**Buttresses, compression struts, or similar elements are required to contain and absorb the horizontal components of the cable thrusts.**



**lenticular structure**  
A lens-shaped structure having the outward thrusts of an arch balanced by the inward pulls of a cable, resulting in no net lateral forces at the supports.

**drop ceiling**

A secondary ceiling formed to provide space for piping or ductwork, or to alter the proportions of a room. Also, *dropped ceiling*.

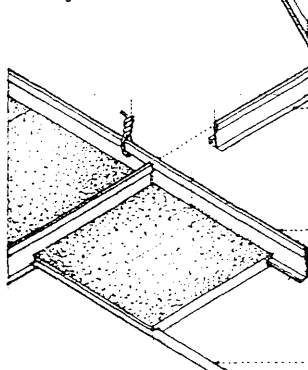


**acoustical tile**

Tile made in various sizes and textures from a soft, sound-absorbing material, as cork, mineral fiber, or glass fiber.

**metal pan**

An acoustical tile consisting of a steel or aluminum pan having a perforated face and containing a separate layer of sound-absorbing material.



**cross tee**

A secondary member of the grid supporting a suspended ceiling system, usually a sheet-metal tee carried by the main runners.

**main runner**

A principal member of the grid supporting a suspended ceiling system, usually a sheet-metal channel or tee suspended by hanger wires from the overhead structure.

**spline**

A thin metal strip inserted into the edges of two acoustical tiles to make a butt joint between them.



**kerf**

A groove cut in to the edges of an acoustical tile to receive a spline or T-shaped member of a supporting grid.

**suspended ceiling**

A ceiling suspended from an overhead floor or roof structure to provide space for pipes, ductwork, lighting fixtures, or other service equipment.

**plenum**

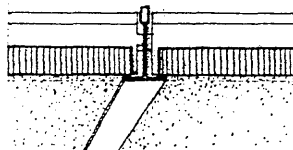
The space between a suspended ceiling and the floor structure above, esp. one that serves as a receiving chamber for conditioned air to be distributed to inhabited spaces or for return air to be conveyed back to a central plant for processing.

**acoustical ceiling**

A ceiling of acoustical tile or other sound-absorbing material.

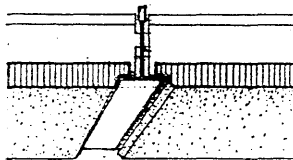
**exposed grid**

A metal grid of inverted tees supporting the acoustical tiles of a suspended ceiling.



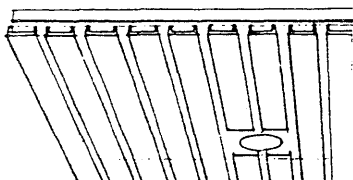
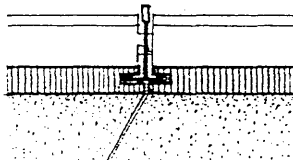
**recessed grid**

A metal grid for supporting a suspended ceiling of acoustical tiles having rabbeted joints.



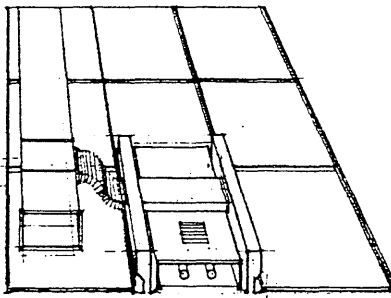
**concealed grid**

A metal grid supporting the acoustical tiles of a suspended ceiling, hidden within kerfs cut into the edges of the tiles.



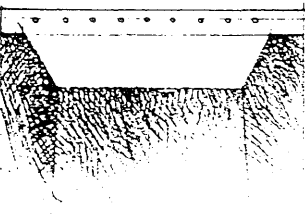
**linear metal ceiling**

A suspended ceiling system of narrow metal strips, usually incorporating modular lighting and air-handling components.



**integrated ceiling**

A suspended ceiling system incorporating acoustical, lighting, and air-handling components into a unified whole.

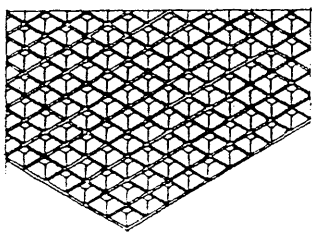


**luminous ceiling**

A suspended ceiling of translucent panels for diffusing the light from luminaires mounted above it.

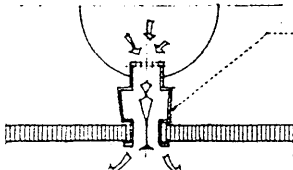
**louvered ceiling**

A suspended ceiling of multicellular louvers for shielding the light sources mounted above it.



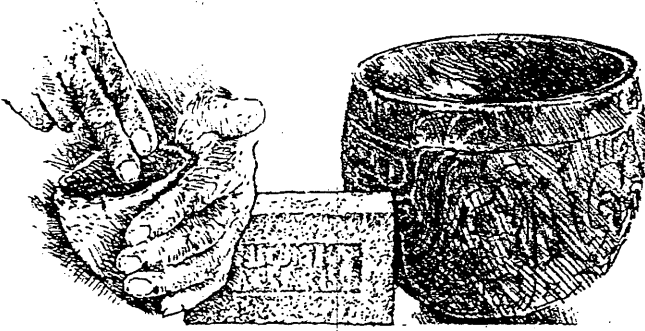
**linear diffuser**

A long, narrow diffuser designed to disperse air through slots between the panels of an integrated ceiling system. Also called *slot diffuser*.



# CERAMIC

Any of various hard, brittle, noncorrosive, and nonconductive materials formed by the ionic bonding of a metal and a nonmetal, as brick, concrete, and natural stone.



## ceramic ware

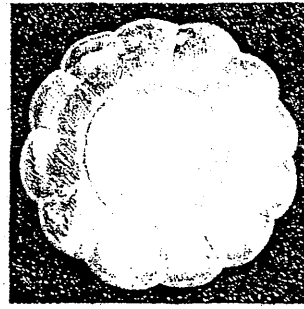
Any of various products made by firing clay or similar materials in a kiln, as brick, tile, and pottery.

## earthenware

Low-fired, opaque, nonvitreous ceramic ware.

## stoneware

High-fired, opaque, vitrified ceramic ware.



## porcelain

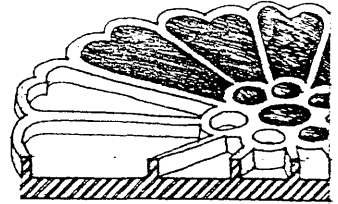
A hard, vitreous, translucent ceramic material consisting essentially of kaolin, feldspar, and quartz, fired at a very high temperature.

## china

A translucent ceramic material, bisque-fired at a high temperature and glaze-fired at a lower temperature.

## kaolin

A fine white clay used in the manufacture of porcelain and white portland cement. Also called china clay.

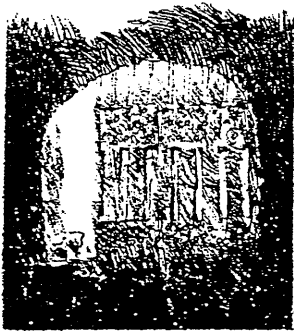


## enamel

A vitreous, usually opaque, decorative or protective coating applied by fusion to the surface of metal, glass, or pottery.

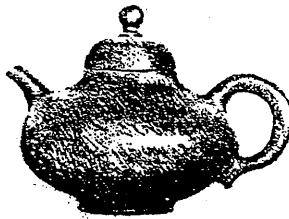
## porcelain enamel

An opaque, glassy coating bonded to metal by fusing at a high temperature. Also called vitreous enamel.



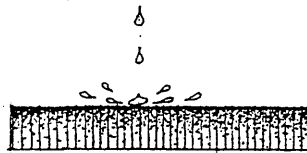
## firing

The process of hardening or glazing ceramic ware by heating in a kiln to a specified temperature.



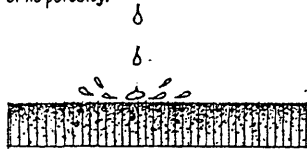
## vitrify

To make a clay body vitreous by firing at a specified temperature.



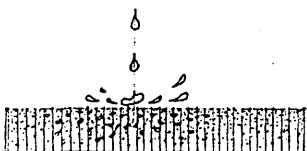
## vitreous

Resembling glass, as in transparency, hardness, brittleness, luster, or having low or no porosity.



## semivitreous

Having a moderate water absorption of slightly under 6%.



## nonvitreous

Having a water absorption greater than 7%.



## ceramic bond

A thermochemical bond between materials resulting from exposure to temperatures approaching the fusion point of the mixture.

## body

The structural portion of a ceramic article or the clay material or mixture from which it is made.

## bisque-fired

Fired to harden a clay body.

## bisque

Earthenware or porcelain that has been fired once but not glazed. Also called biscuit.

## glaze-fired

Fired to fuse a glaze to a clay body.

## glaze

A vitreous layer or coating fused to a clay body to color, decorate, waterproof, or strengthen its surface.

## frit

A fused or partially fused material that is ground to introduce a soluble or unstable ingredients into glazes or enamels.

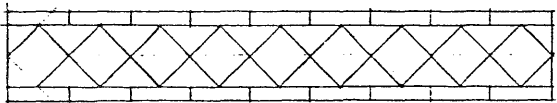
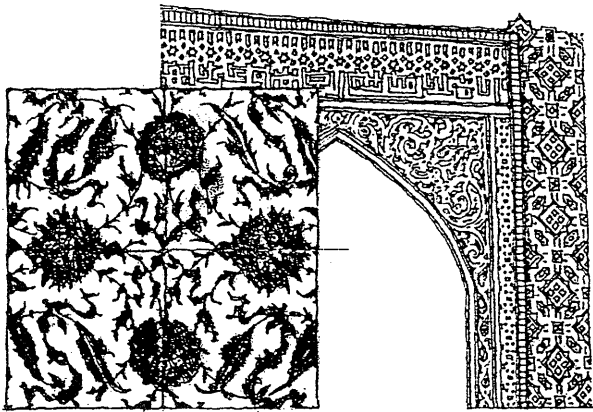
## hard-burned

Fired at a high temperature to near vitrification and having relatively low absorption and high compressive strength.

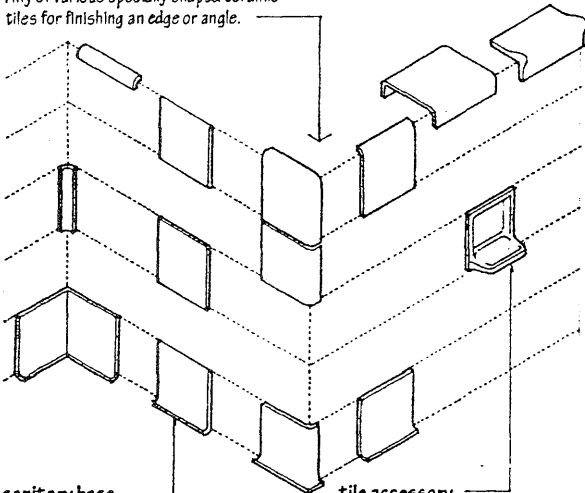
## soft-burned

Fired at a low temperature and having relatively high absorption and low compressive strength.



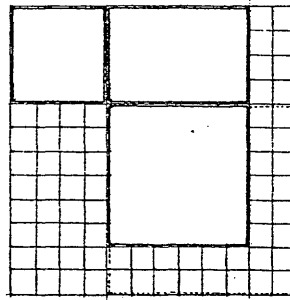


**trimmer**  
Any of various specially shaped ceramic tiles for finishing an edge or angle.



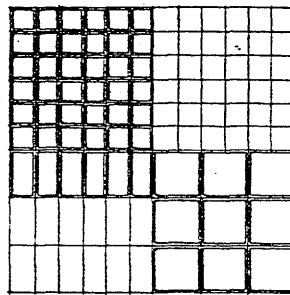
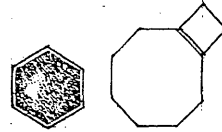
**sanitary base**  
A covered tile set at the meeting of a floor and wall to prevent accumulation of dirt and to facilitate cleaning.

**tile accessory**  
Any of the ceramic or nonceramic articles designed to be affixed to or inserted in tilework, as towel bars, soap holders, and the like.

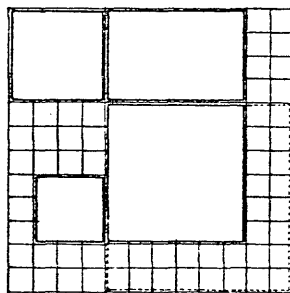


**ceramic tile**  
Any of various fired clay tiles used for surfacing walls, floors, and countertops.

**glazed wall tile**  
Ceramic tile having a nonvitreous body and a bright, matte, or crystalline glaze, used for surfacing interior walls and light-duty floors.

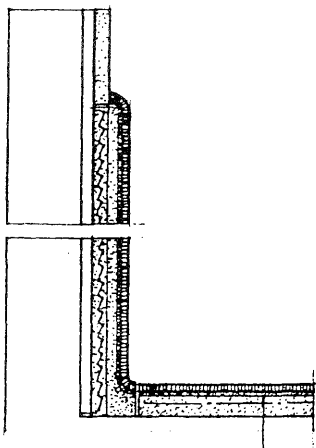
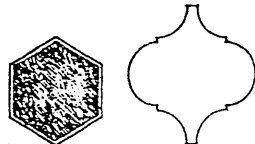


**ceramic mosaic tile**  
Small ceramic tile having a porcelain or natural clay body, glazed for surfacing walls or unglazed for use on both floors and walls, and usually face- or back-mounted on sheets to facilitate handling and speed installation.



**quarry tile**  
Unglazed ceramic floor tile having a natural clay body. Also called promenade tile.

**paver tile**  
Unglazed ceramic floor tile similar in composition to ceramic mosaic tile but thicker and larger in surface area.



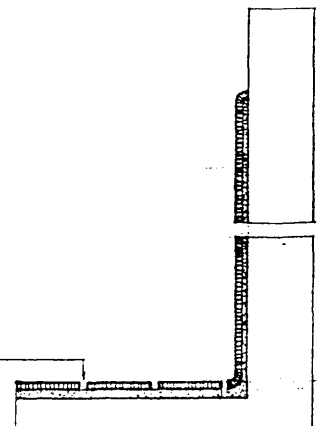
**thick-set process**  
A tiling process in which ceramic tile is applied over a portland cement mortar bed 3/4 to 1 1/2 in. (19 to 38 mm) thick, which allows for accurate slopes and planes in the finished work.

**portland cement mortar**  
A field mix of portland cement, sand, water, and sometimes hydrated lime, used for leveling or setting ceramic tile in the thick-set process.

**bond coat**  
A thin coat of mortar for bonding ceramic tile to a backing.

**thin-bed process**  
A tiling process in which ceramic tile is bonded to a continuous, stable backing with a thin coat of dry-set mortar, latex-portland cement mortar, epoxy mortar, or an organic adhesive, 1/32 to 1/8 in. (0.8 to 3.2 mm) thick.

**tile grout**  
A cementitious or resinous mix for filling joints in ceramic tilework.



# CERAMIC

## structural clay tile

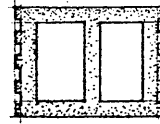
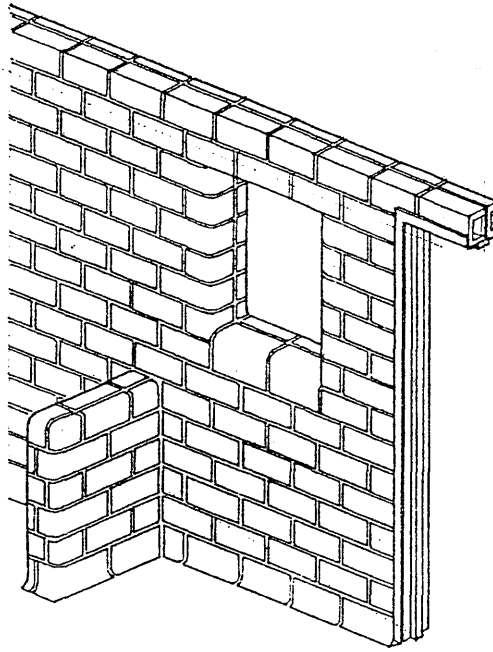
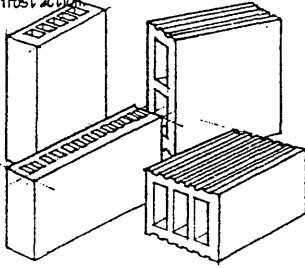
A hollow tile of fired clay having parallel cells or cores, used in building walls and partitions.

### LB

Load-bearing structural clay tile suitable for masonry walls not exposed to frost action, or in exposed masonry where protected by a facing of 3 in. (76.2 mm) or more of stone, brick, terra cotta, or other masonry.

### LBX

Load-bearing structural clay tile suitable for masonry walls exposed to weathering or frost action.



## hollow tile

Any of various cellular building units of fired clay, concrete, or gypsum, used for building walls, floors, and roofs, or for fireproofing steelwork.

## structural facing tile

Structural clay tile having a glazed surface, used for facing walls and partitions, esp. in areas subject to heavy wear, moisture problems, and strict sanitation requirements.

### FTS

Structural facing tile suitable for exposed exterior and interior masonry walls and partitions where moderate absorption, slight variation in face dimensions, minor defects in surface finish, and medium color range are acceptable.

### FTX

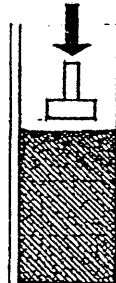
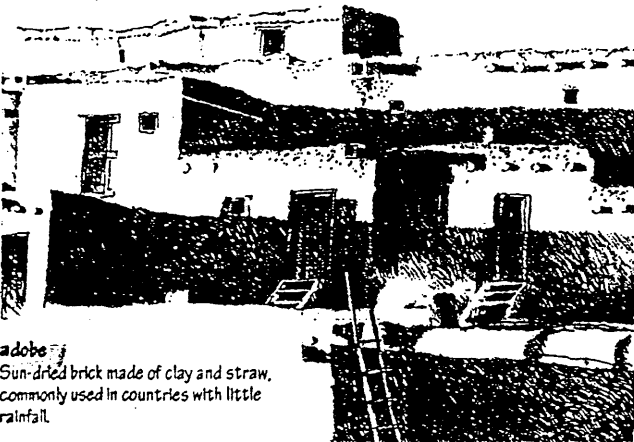
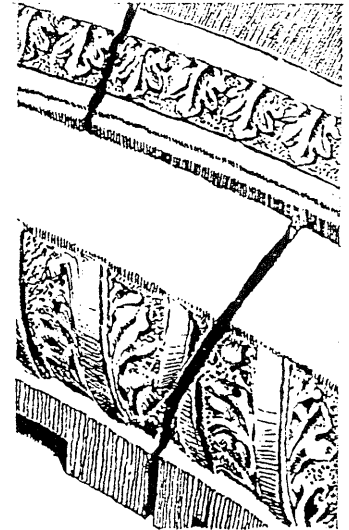
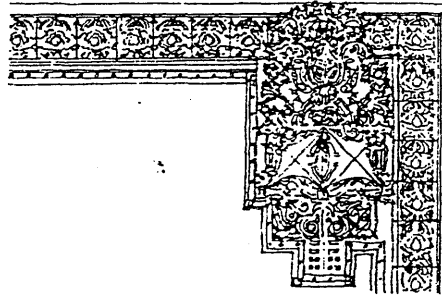
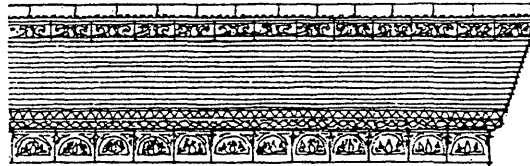
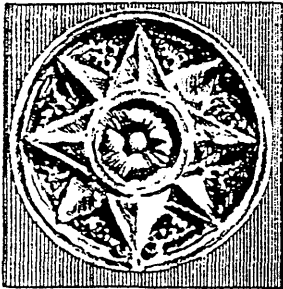
Smooth structural facing tile suitable for exposed exterior and interior masonry walls and partitions where low absorption and stain resistance are required, and where a high degree of mechanical perfection, minimum variation in face dimensions, and narrow color range are desired.

## terra cotta

A hard, fired clay, reddish-brown in color when unglazed, used for architectural facings and ornaments, tile units, and pottery.

## architectural terra cotta

Hard-burned, glazed or unglazed terra cotta, hand-molded or machine-extruded to order as a ceramic veneer for walls or for ornamentation.



## rammed earth

A stiff mixture of clay, sand or other aggregate, and water compressed and dried within forms as a wall construction. Also called *pisé*, *pisay*, *pisé de terre*.

A building for public Christian worship.

**Christianity**

The religion, founded on the teachings of Jesus Christ, including the Catholic, Protestant, and Eastern Orthodox churches.

**basilica**

An early Christian church, characterized by a long, rectangular plan, a high colonnaded nave lit by a clerestory and covered by a timbered gable roof, two or four lower side aisles, a semicircular apse at the end, a narthex, and often other features, as an atrium, a bema, and small semicircular apses terminating the aisles.

**atrium**

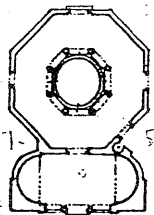
The forecourt of an early Christian church, flanked or surrounded by porticoes.

**ambulatory**

The covered walk of an atrium or cloister.

**anathemas**

A basin for a ritual cleansing with water in the atrium of an early Christian basilica.



**baptistry**

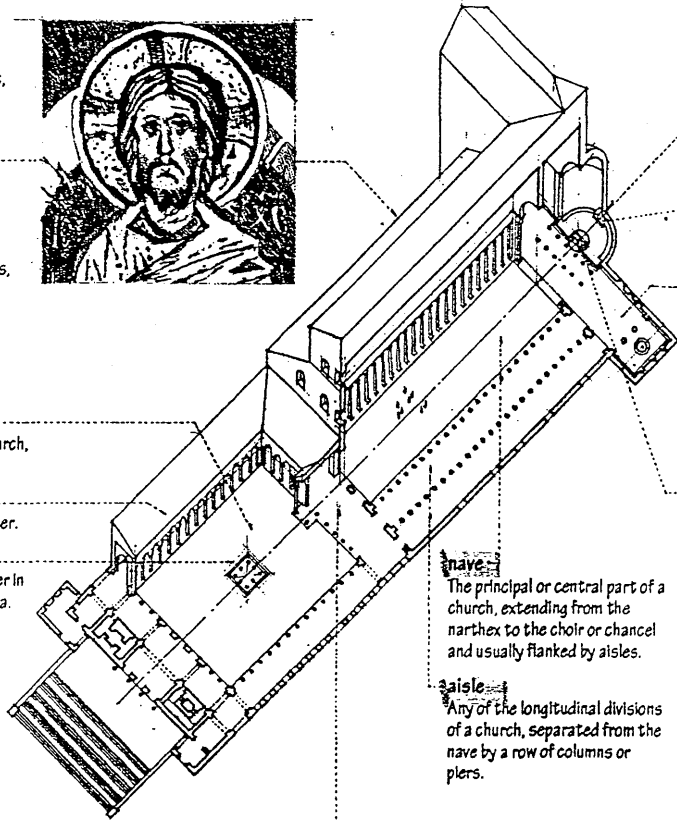
A part of a church or a separate building in which baptism is administered. Also, baptistry.

**baptism**

A sacrament of initiation into Christianity, symbolic of spiritual regeneration, marked by a ceremonial immersion or application of water.

**font**

A basin, usually of stone, holding the water used in baptism.



**apse**

A semicircular or polygonal projection of a building, usually vaulted and used esp. at the sanctuary or east end of a church. Also, apsis.

**tribune**

The bishop's throne, occupying a recess or apse in an early Christian church.

**bema**

A transverse open space separating the nave and the apse of an early Christian church, developing into the transept of later cruciform churches.

**sanctuary**

A sacred or holy place, as that part of a church in which the principal altar is placed.

**altar**

The table in a Christian church upon which the Eucharist, the sacrament celebrating Christ's Last Supper, is celebrated. Also called **communion table**.

**baldachin**

An ornamental canopy of stone or marble permanently placed over the altar in a church. Also, baldachino, baldaquin. Also called ciborium.

**nave**

The principal or central part of a church, extending from the narthex to the choir or chancel and usually flanked by aisles.

**aisle**

Any of the longitudinal divisions of a church, separated from the nave by a row of columns or piers.

**narthex**

The portico before the nave of an early Christian or Byzantine church, appropriated to penitents.

**esonarthex**

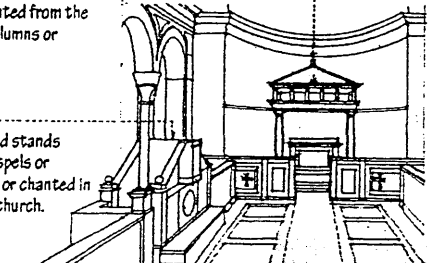
An inner narthex when two are present.

**exonarthex**

A covered walk or outer narthex situated before an inner narthex.

**ambo**

Either of two raised stands from which the Gospels or Epistles were read or chanted in an early Christian church. Also, ambon.



**cancell**

A low screen in an early Christian basilica, separating the clergy and sometimes the choir from the congregation.

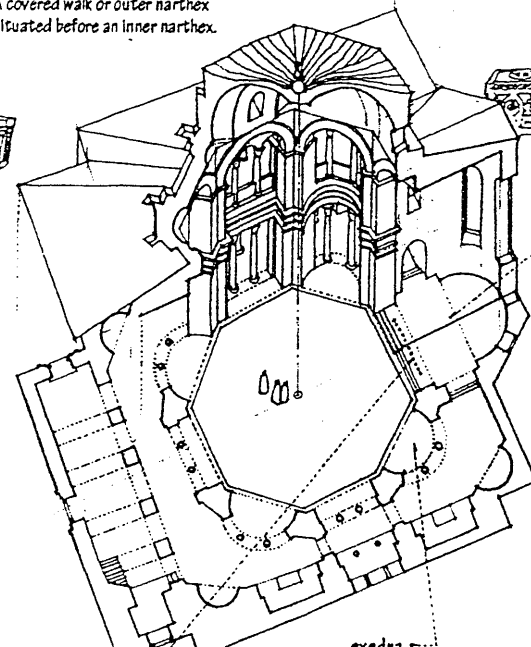
**sarcophagus**

A stone coffin, esp. one bearing sculpture or inscriptions and displayed as a monument.



**icon**

A representation of a sacred Christian personage, as Christ or a saint or angel, typically painted on a wood surface and itself venerated as being sacred, esp. in the tradition of the Eastern Church.



**bema**

The sanctuary space surrounding the altar of an Eastern church.

**diaconicon**

A sacristy in an early Christian or Eastern church, usually on the south side of the bema.

**sacristy**

A room in a church where the sacred vessels and vestments are kept. Also called vestry.

**prothesis**

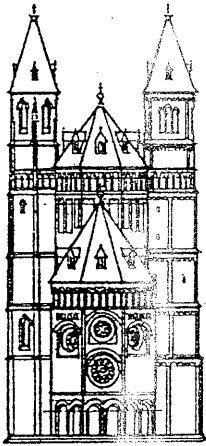
A chapel in an Eastern Church where the Eucharistic elements are prepared, usually on the north side of the bema.

**exedra**

A large apsidal extension of the interior volume of a church. Also, *exhedra*.

**iconostasis**

A screen or partition on which icons are placed, separating the bema from the nave of an Eastern church. Also, *iconostas*.

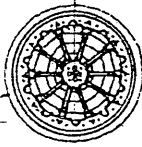


**westwork**

The monumental western front of a Romanesque church, treated as a tower or towers containing a low entrance hall below and a chapel open to the nave above.

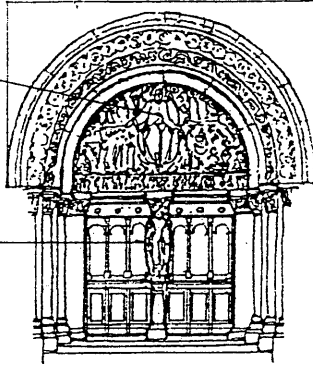
**wheel window**

A rose window having distinctly radiating mullions or bars. Also called Catherine wheel, marigold window.



**tympanum**

The space between an arch and the horizontal head of a door or window below, often decorated with sculpture.



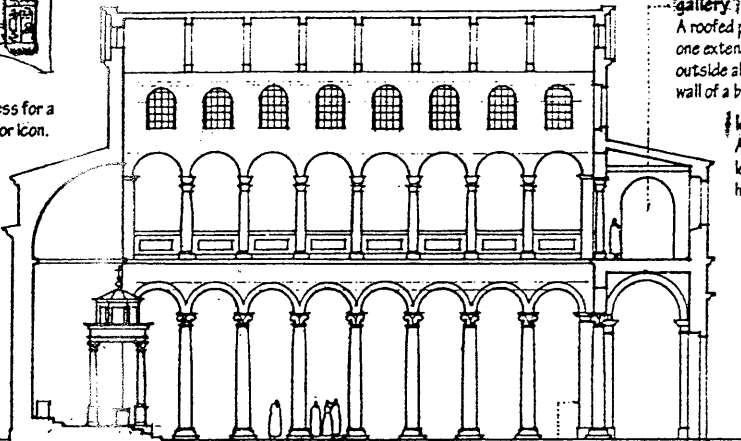
**trumeau**

A column supporting the tympanum of a doorway at its center.



**tabernacle**

A canopied recess for a religious image or icon.



**arcade**

A series of arches supported on piers or columns.

**arcuate**

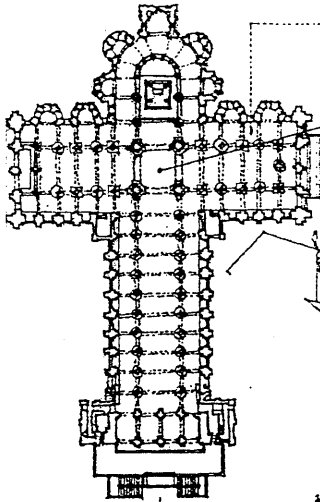
Curved or arched like a bow; a term used in describing the arched or vaulted structure of a Romanesque church or Gothic cathedral, as distinguished from the trabeated architecture of an Egyptian hypostyle hall or Greek Doric temple. Also, arcuated.

**respond**

A pier or pilaster projecting from a wall as a support for an arch or lintel, esp. at the termination of an arcade or colonnade.

**dossieret**

A thickened abacus or supplementary capital set above a column capital to receive the thrust of an arch. Also called impost block.

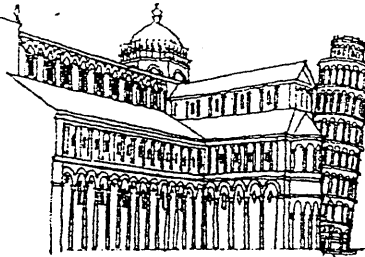


**transept**

The major transverse part of a cruciform church, crossing the main axis at a right angle between the nave and choir.

**crossing**

The intersection of the nave and transept in a cruciform church.

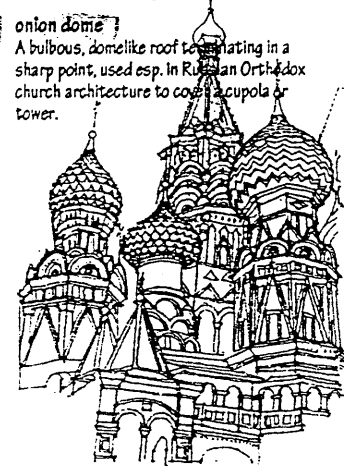


**campanile**

A bell tower, usually one near but not attached to the body of a church.

**onion dome**

A bulbous, domelike roof terminating in a sharp point, used esp. in Russian Orthodox church architecture to cover a cupola or tower.

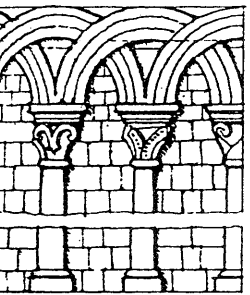


**gallery**

A roofed promenade, esp. one extending inside or outside along the exterior wall of a building.

**loft**

A gallery or upper level in a church or hall.



**interlacing arcade**

An arcade, esp. a blind one, composed of arches resting on alternate supports and overlapping in series where they cross. Also called intersecting arcade.

**blind arcade**

A series of arches superimposed on a wall for decoration. Also called arcature.

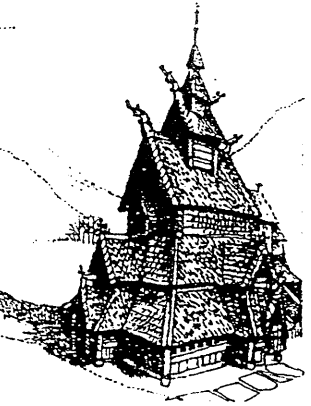


**spire**

A tall, acutely tapering pyramidal structure surmounting a steeple or tower.

**steeple**

A tall ornamental structure, usually ending in a spire and surmounting the tower of a church or other public building.

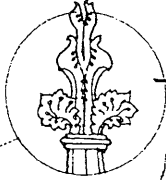


**stave church**

An indigenous Scandinavian church of the 12th and 13th centuries, having a timber frame, plank walls, a tiered, steeply pitched roof, and few windows.

**fleche**

A slender spire rising from the ridge of a roof, esp. one above the crossing of a Gothic church.



**finial**

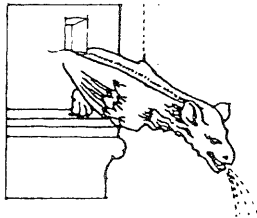
A relatively small, usually foliated ornament terminating the peak of a spire or pinnacle.

**crocket**

A projecting ornament, usually in the form of curved foliage, used esp. in Gothic architecture to decorate the outer angles of pinnacles, spires, and gables.

**gargoyle**

A grotesquely carved figure of a human or animal, esp. one with an open mouth that serves as a spout and projects from a gutter to throw rainwater clear of a building.



**rose window**

A circular window, usually of stained glass and decorated with tracery symmetrical about the center.

**stained glass**

Glass colored or stained by having pigments baked onto its surface or by having various metallic oxides fused into it while in a molten state.

**triforium**

An arcaded story in a church, between the nave arches and clerestory and corresponding to the space between the vaulting and the roof of an aisle.

**crypt**

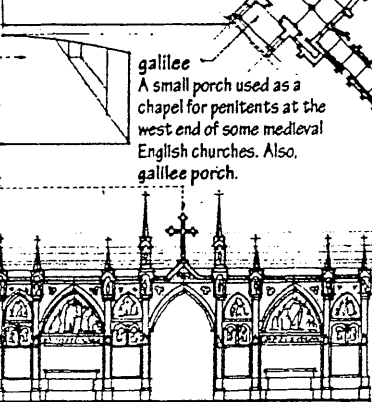
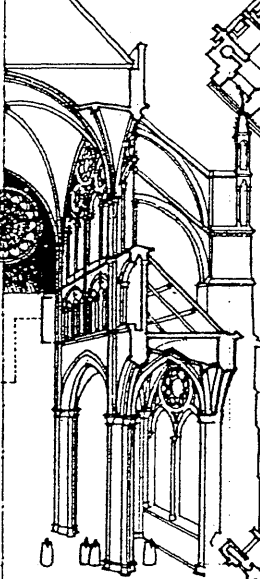
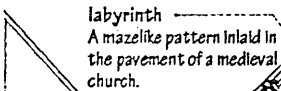
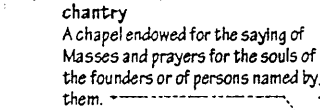
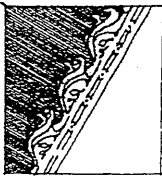
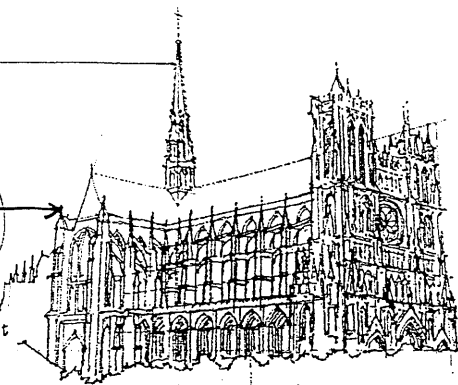
An underground chamber or vault used as a burial place, esp. one beneath the main floor of a church.

**rood**

A crucifix symbolizing the cross on which Christ was crucified, esp. a large one set above the entrance to the choir or chancel of a medieval church.

**rood screen**

A screen, often elaborately adorned and properly surmounted by a rood, separating the chancel or choir from the nave of a medieval church.



**cathedral**

The principal church of a diocese, containing the bishop's throne called the *cathedra*.

**chapel**

A separately dedicated part of a church for private prayer, meditation, or small religious services.

**chancel**

The space about the altar of a church for the clergy and choir, often elevated above the nave and separated from it by a railing or screen.

**chevet**

The rounded east end of a Gothic cathedral, including the apse and ambulatory.

**ambulatory**

An aisle encircling the end of the choir or chancel of a church. Also called *deambulatory*.

**choir**

The part of a church occupied by the singers of a choir, usually part of the chancel.

**retrochoir**

A separate division behind the choir or high altar of a large church.

**Lady chapel**

A chapel dedicated to the Virgin Mary, usually located behind the high altar of a cathedral at the extremity of the apse.

**high altar**

The main altar of a church.

**presbytery**

The part of a church reserved for the officiating clergy.

**close**

An enclosed place, esp. the land surrounding or beside a cathedral.

**slupe**

A covered passage, esp. one between the transept and chapter house of a cathedral. Also, *slip*.

**chapter house**

The place where the chapter of a cathedral or monastery meets, usually a building attached to or a hall forming part of the cathedral or monastery.

**chapter**

An assembly of the monks in a monastery, or the members of a religious house or order.

**paradise**

An atrium or cloister beside a church.

**cloister**

A covered walk having an arcade or colonnade on one side opening onto a courtyard.

**garth**

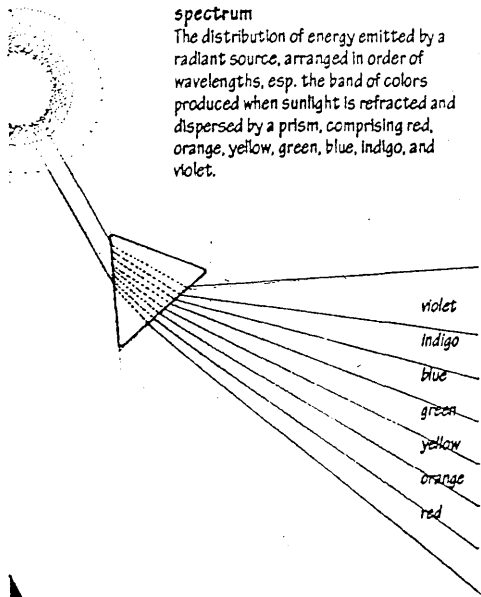
A courtyard or quadrangle enclosed by a cloister. Also called *cloister garth*.

**alure**

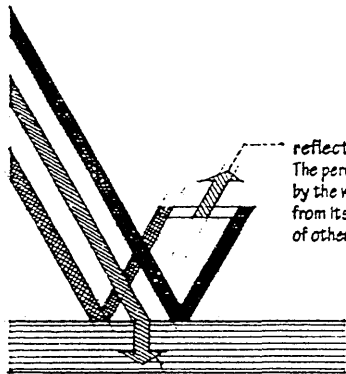
A walk or passage, as along a cloister or behind the parapets of a castle. Also, *allure*.

# COLOR

A phenomenon of light and visual perception that may be described in terms of an individual's perception of hue, saturation, and lightness for objects, and hue, saturation, and brightness for light sources.



**spectrum**  
The distribution of energy emitted by a radiant source, arranged in order of wavelengths, esp. the band of colors produced when sunlight is refracted and dispersed by a prism, comprising red, orange, yellow, green, blue, indigo, and violet.

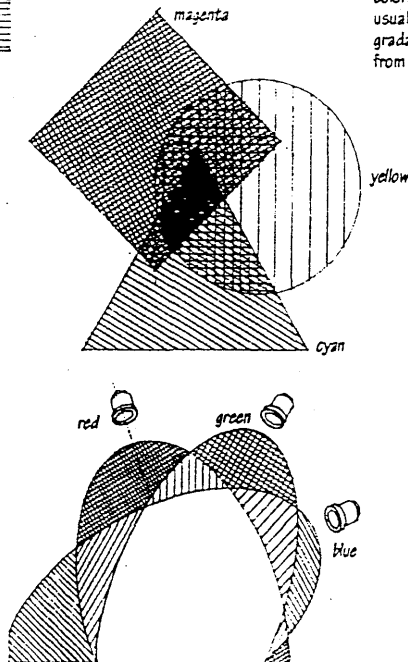


**reflected color**  
The perceived color of an object, determined by the wavelengths of the light reflected from its surface after selective absorption of other wavelengths of the incident light.

**selective absorption**  
The absorption of certain wavelengths of the light incident on a colored surface, the remaining portion being reflected or transmitted.

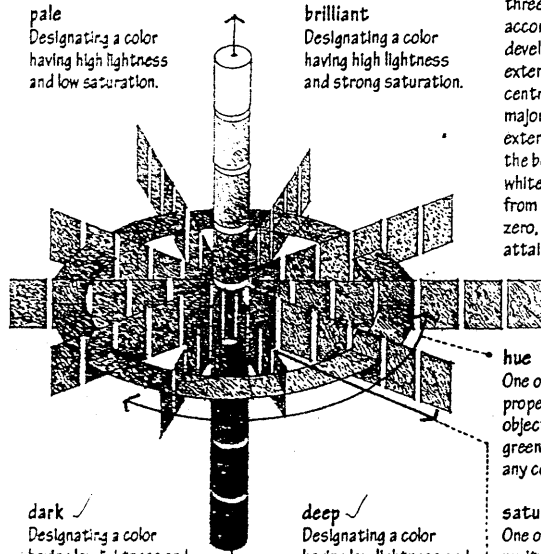
**subtractive color**  
A color produced by mixing cyan, yellow, and magenta pigments, each of which absorbs certain wavelengths. A balanced mixture of these colorant or subtractive primaries theoretically yields black since it absorbs all wavelengths of visible light.

**additive color**  
A color produced by combining lights of red, green, and blue wavelengths. These light or additive primaries contain all the wavelengths necessary to produce a colorless or white light.



**pale**  
Designating a color having high lightness and low saturation.

**brilliant**  
Designating a color having high lightness and strong saturation.



**dark**  
Designating a color having low lightness and low saturation, and reflecting only a small fraction of incident light.

**deep**  
Designating a color having low lightness and strong saturation.

**Munsell System**  
A system for specifying colors arranged in three orderly scales of uniform visual steps according to hue, chroma, and value, developed in 1898 by Albert H. Munsell. Hue extends in a rotary direction about a central axis through a spectrum of five major and five secondary hues. Value extends vertically direction from black at the bottom through a series of grays to white at the top. Chroma extends radially from the central axis at which saturation is zero, out to the strongest saturation attainable for each color's hue and value.

**hue**  
One of the three dimensions of color: the property of light by which the color of an object is classified as being red, yellow, green, or blue, or an intermediate between any contiguous pair of these colors.

**saturation**  
One of the three dimensions of color: the purity or vividness of a hue. Also called intensity.

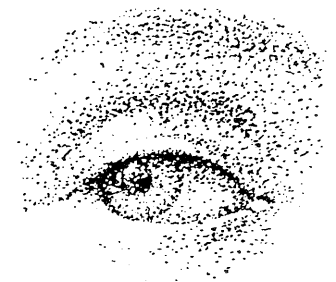
**chroma**  
The degree by which a color differs from a gray of the same lightness or brightness, corresponding to saturation of the perceived color.

**lightness**  
The dimension of color by which an object appears to reflect more or less of the incident light, varying from black to white for surface colors and from black to colorless for transparent volume colors.

**value**  
The degree by which a color appears to reflect more or less of the incident light, corresponding to lightness of the perceived color.

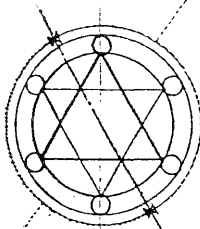
**brightness**  
The dimension of a color which is correlated with luminance and by which visual stimuli are ordered continuously from very dim to very bright. Pure white has the maximum brightness, and pure black the minimum brightness.

**gray scale**  
A scale of achromatic colors having several, usually ten, equal gradations ranging from white to black.

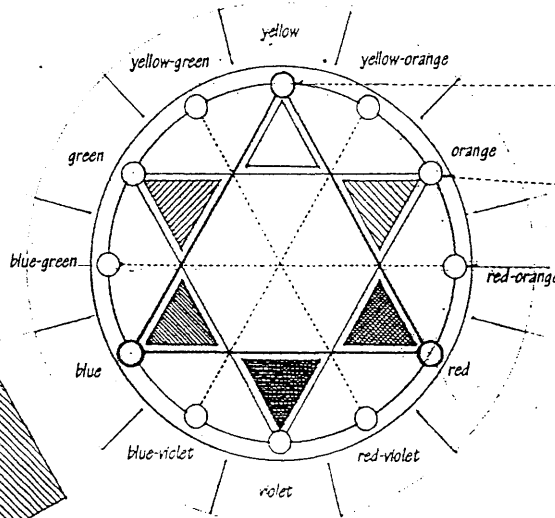


**optical mixing**  
The merging of juxtaposed dots or strokes of pure colors when seen from a distance to produce a hue often more luminous than that available from a premixed pigment.

**warm**  
Designating a color inclined toward or dominated by red, orange, or yellow.



**cool**  
Designating a color inclined toward or dominated by green, blue, or violet.



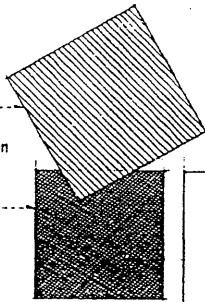
**color wheel**  
A circular scale of the colors of the spectrum, showing complementary colors opposite each other. Also called color circle.

**primary color**  
Any of a set of colors, as red, yellow, and blue, regarded as generating all other colors.

**secondary color**  
A color, as orange, green, or violet, produced by mixing two primary colors.

**tertiary color**  
A color, as brown, produced by mixing two secondary colors, or a secondary color with one of its constituent primaries.

**advancing color**  
A warm color that appears to move toward an observer, giving an illusion of space.

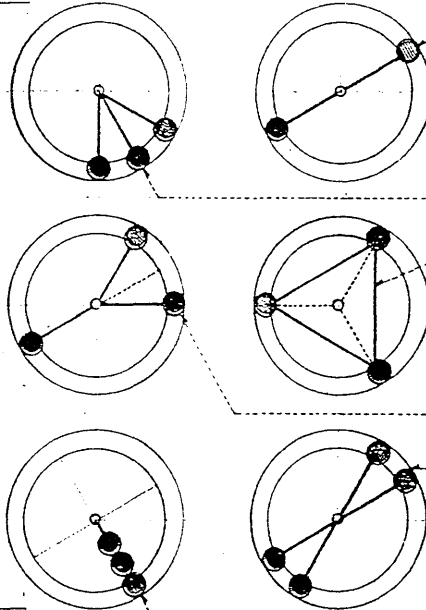


**receding color**  
A cool color that appears to move away from an observer, giving an illusion of space.

**complementary color**  
One of a pair of opposing colors on a color wheel, perceived as completing or enhancing each other.

**analogous color**  
One of two or three closely related colors on a color wheel.

**color scheme**  
An arrangement or pattern of colors conceived of as forming an integrated whole.



**triad**  
A combination of three colors forming an equilateral triangle on a color wheel.

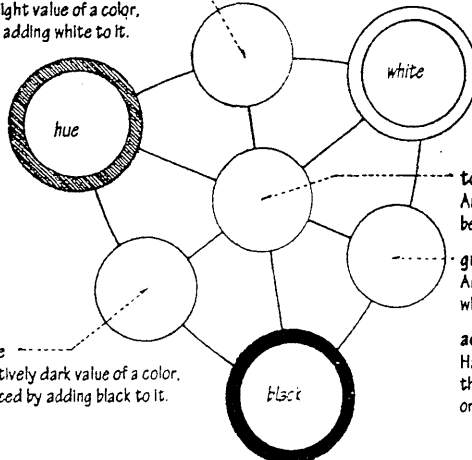
**split complementary**  
A combination of one color and the pair of colors adjoining its complementary color on a color wheel.

**double complementary**  
A combination of two analogous colors and their complementary colors on a color wheel.

**monochromatic**  
Having only one color or exhibiting varying intensities and values of a single hue.

**polychromatic**  
Having or exhibiting a variety of colors.

**color triangle**  
A triangular diagram developed by Faber Birren to describe the relationship between a pure hue, white, and black, which combine to yield secondary tints, tones, shades, and grays. All colors may be subjectively conceived as a mixture of the psychological primaries - red, yellow, green, and blue - plus the achromatic pair of white and black.



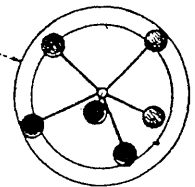
**tint**  
A relatively light value of a color, produced by adding white to it.

**tone**  
An intermediate value of a color between a tint and a shade.

**gray**  
An achromatic color between white and black.

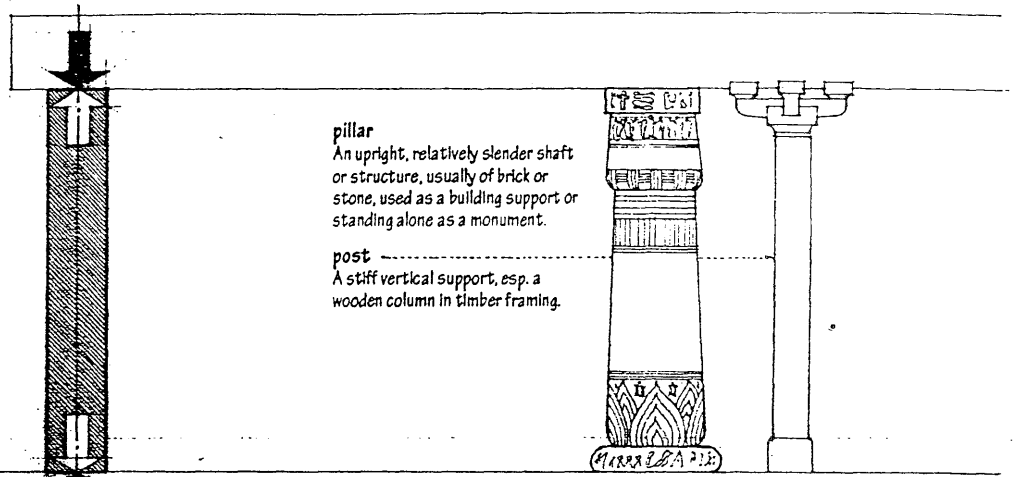
**achromatic**  
Having no saturation and therefore no hue, as white, black, or gray.

**shade**  
A relatively dark value of a color, produced by adding black to it.



# COLUMN

A rigid, relatively slender structural member designed primarily to support axial, compressive loads applied at the member ends.



**pillar**  
An upright, relatively slender shaft or structure, usually of brick or stone, used as a building support or standing alone as a monument.

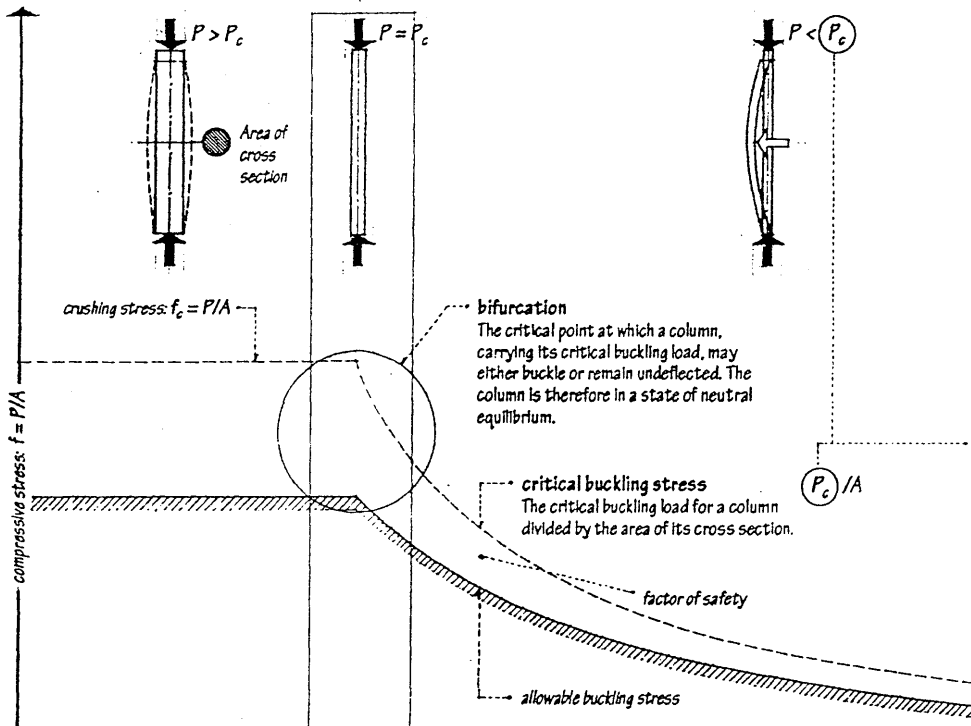
**post**  
A stiff vertical support, esp. a wooden column in timber framing.

**buckling**  
The sudden lateral or torsional instability of a slender structural member induced by the action of a compressive load. Buckling can occur well before the yield stress of the material is reached.

**buckling load**  
The axial load at which a column begins to deflect laterally and becomes unstable.

Under a buckling load, a column cannot generate the internal forces necessary to restore its original linear condition. Any additional loading would cause the column to deflect further until collapse occurs in bending. Most columns in practice are subject to both compression and bending due to variation in material properties, initial crookedness in fabrication, or some eccentricity in load application. This bending often causes the actual buckling load to be slightly lower than the critical buckling load.

**critical buckling load**  
The maximum axial load that can theoretically be applied to a column without causing it to buckle. The critical buckling load for a column is inversely proportional to the square of its effective length, and directly proportional to the modulus of elasticity of the material and to the moment of inertia of the cross section. Also called Euler buckling load.



crushing stress:  $f_c = P/A$

**bifurcation**  
The critical point at which a column, carrying its critical buckling load, may either buckle or remain undeflected. The column is therefore in a state of neutral equilibrium.

**critical buckling stress**  
The critical buckling load for a column divided by the area of its cross section.

factor of safety

allowable buckling stress

compressive stress:  $f = P/A$

$P_c/A$

**slenderness ratio**  
The ratio of the effective length of a column to its least radius of gyration.

The higher the slenderness ratio, the lower is the critical stress that will cause buckling. A primary objective in the design of a column is to reduce its slenderness ratio by minimizing its effective length or maximizing the radius of gyration of its cross section.

$$L_e/r$$

$$r = \sqrt{I/A}$$

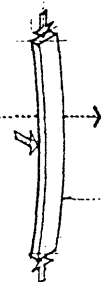
**radius of gyration**  
The radial distance from any axis to a point at which the mass of a body could be concentrated without altering the moment of inertia of the body about that axis. For a structural section, the radius of gyration is equal to the square root of the quotient of the moment of inertia and the area.

The higher the radius of gyration of a structural section, the more resistant the section is to buckling. In determining the cross-sectional shape of a column, the objective is to provide the necessary radius of gyration about the different axes. For an asymmetrical cross section, buckling will tend to occur about the weaker axis or in the direction of the least dimension.

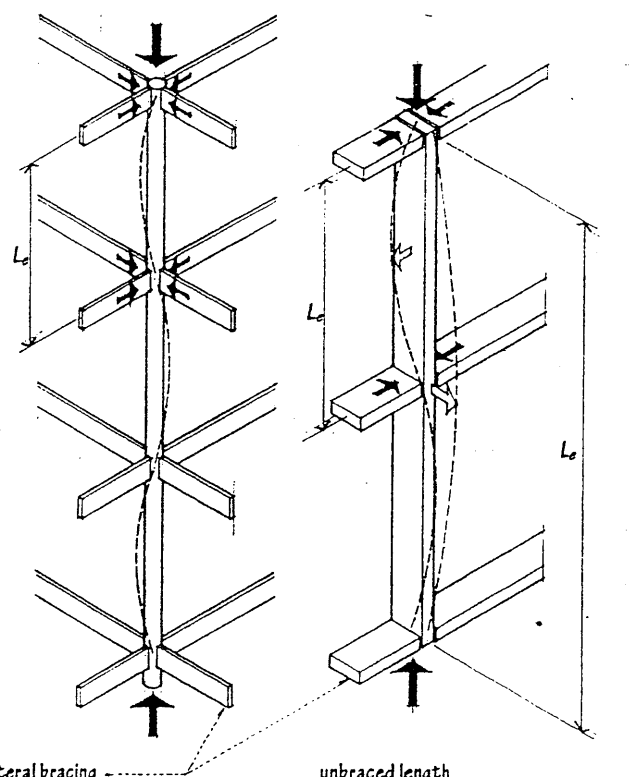
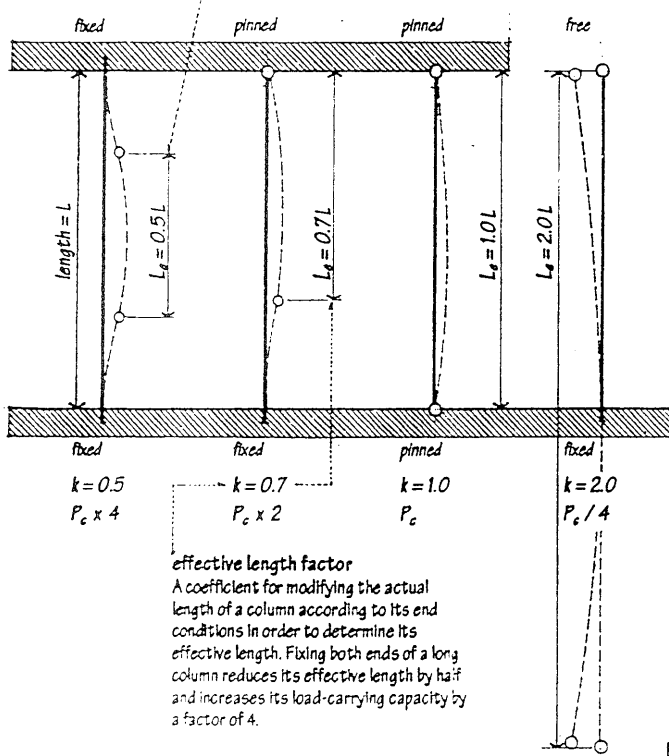
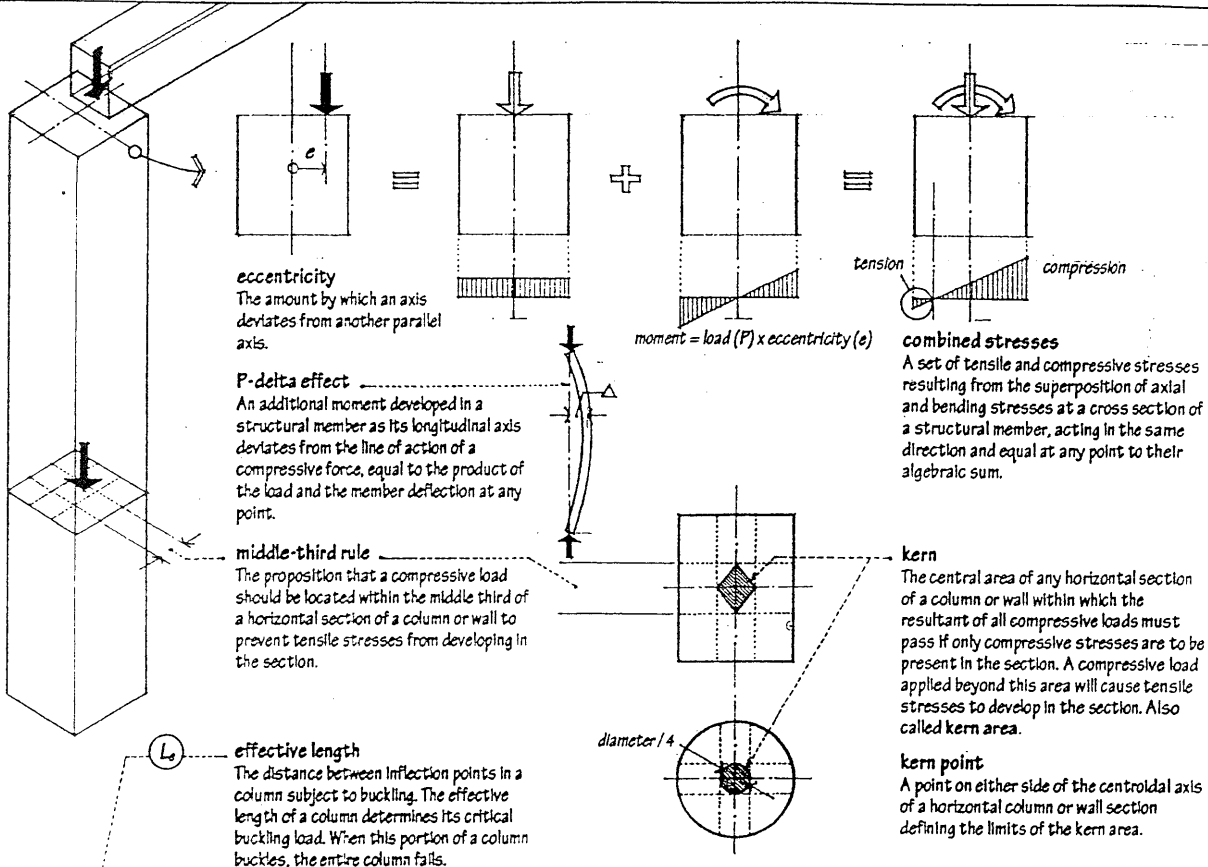
**short column**  
A thick column subject to failure by crushing rather than by buckling. Failure occurs when the direct stress from an axial load exceeds the compressive strength of the material available in the cross section. An eccentric load, however, can produce bending and result in an uneven stress distribution in the section.

**intermediate column**  
A column having a mode of failure between that of a short column and a long column, often partly inelastic by crushing and partly elastic by buckling.

**long column**  
A slender column subject to failure by buckling rather than by crushing.







# CONCRETE

An artificial, stonelike building material made by mixing cement and various mineral aggregates with sufficient water to cause the cement to set and bind the entire mass.



## natural cement

A naturally occurring clayey limestone which, when calcined and finely pulverized, produces a hydraulic cement.

## pozzolan

A siliceous material, as fly ash, that reacts chemically with slaked lime in the presence of moisture to form a slow-hardening cement, named after a natural cement from Pozzuoli, an ancient Roman town near Vesuvius. Also, pozzolona, pozzolana.

## siliceous

Containing silica or a silicate.

## fly ash

Fine particles of ash recovered from the waste gases of a solid-fuel furnace.

## cement

A calcined mixture of clay and limestone, finely pulverized and used as an ingredient in concrete and mortar. The term is frequently used incorrectly for concrete.

## tricalcium silicate

A compound constituting about half the volume of portland cement and responsible for the hardening or early gain in strength of the cement.

## dicalcium silicate

A compound constituting about one-quarter of the volume of portland cement and responsible for the aging or long-term gain in strength of the cement.

## tricalcium aluminate

A compound constituting about one-tenth of the volume of portland cement and responsible for the initial setting of the cement.

## portland cement

A hydraulic cement made by burning a mixture of clay and limestone in a rotary kiln and pulverizing the resulting clinker into a very fine powder, named for its resemblance to a limestone quarried on the Isle of Portland, England.

## hydraulic cement

Cement capable of setting and hardening by a reaction with water.



## Type I: normal

A portland cement used for general construction, having none of the distinguishing qualities of the other types.

## Type II: moderate

A portland cement having a reduced content of tricalcium aluminate, making it more resistant to sulfates and causing it to generate less heat of hydration; used in general construction where resistance to moderate sulfate action is required or where heat buildup can be damaging, as in the construction of large piers and heavy retaining walls.

## Type III: high early strength

A very finely ground portland cement having an increased content of tricalcium silicate, causing it to cure faster and gain strength earlier than normal portland cement; used when the early removal of formwork is desired, or in cold-weather construction to reduce the time required for protection from low temperatures.

## Type IV: low heat

A portland cement having a reduced content of tricalcium silicate and an increased content of dicalcium silicate, causing it to generate less heat of hydration than normal portland cement; used in the construction of massive concrete structures, as gravity dams, where a large buildup in heat can be damaging.

## Type V: sulfate resisting

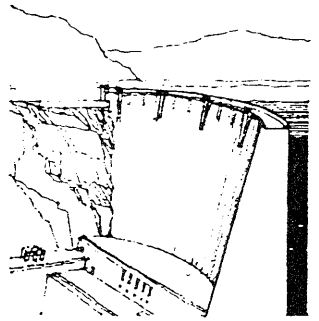
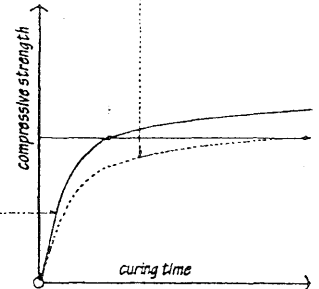
A portland cement having a reduced content of tricalcium aluminate, lessening the need for gypsum, a sulfate normally added to cement to retard its setting time; used where resistance to severe sulfate action is required.

## air-entraining portland cement

A Type I, Type II, or Type III portland cement to which a small quantity of an air-entraining agent has been interground during manufacture; designated by the suffix A, as Type IA, Type IIA, or Type IIIA.

## white portland cement

A portland cement produced from raw materials low in iron oxide and manganese oxide, the substances that give concrete its gray color; used in precast concrete work and in the making of terrazzo, stucco, and tile grout.

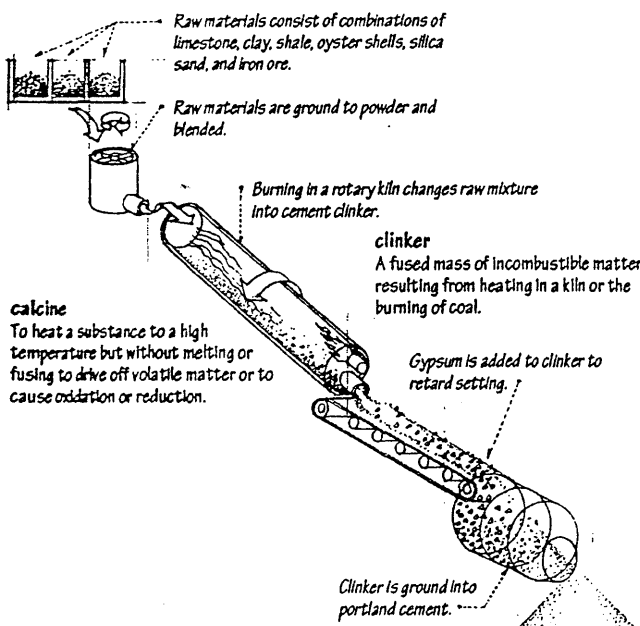


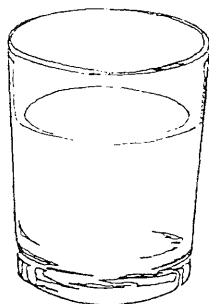
## sulfate action

An expansive reaction occurring when the cement matrix of concrete or mortar comes in contact with sulfates dissolved in ground water or in soil.

## entrained air

Microscopic, spherical air bubbles, typically 0.004 to 0.04 in. (0.1 to 1.0 mm) in diameter, intentionally dispersed in a concrete or mortar mix by an air-entraining agent.



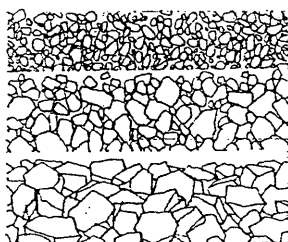


**mixing water**

The water used in a concrete or mortar mix, exclusive of any absorbed by the aggregate and free of such harmful substances as organic material, clay, and salts. Water fit for drinking is generally acceptable.

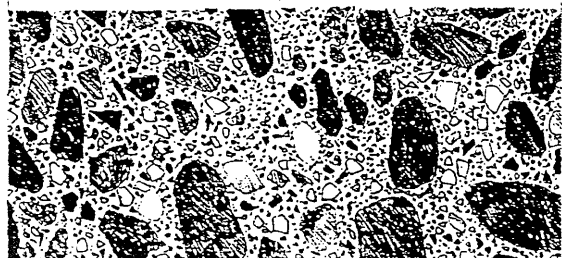
**cement paste**

A mixture of cement and water for coating, setting, and binding the aggregate particles together in a concrete or mortar mix.



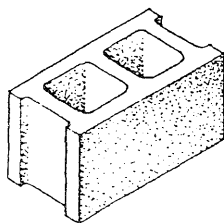
**aggregate**

Any of various hard, inert, mineral materials, as sand and gravel, added to a cement paste to make concrete or mortar. Since aggregate represents from 60% to 80% of the concrete volume, its properties are important to the strength, weight, and fire-resistance of the hardened concrete. Aggregate should be hard, dimensionally stable, and free of clay, silt, and organic matter which can prevent the cementing matrix from binding the particles together.



**lightweight concrete**

Concrete made with aggregate of low specific gravity and weighing less than normal concrete which has a unit weight of about 150 pcf (2,400 kg/m<sup>3</sup>).



**structural lightweight concrete**

Concrete made with strong lightweight aggregate, as expanded shale or slate, having a unit weight from 85 to 115 pcf (1,362 to 1,840 kg/m<sup>3</sup>) and compressive strength comparable to that of normal concrete.

**insulating concrete**

Lightweight concrete having a unit weight of less than 60 pcf (960 kg/m<sup>3</sup>) and low thermal conductivity, made with lightweight aggregate, as perlite, or with a foaming agent or gas-forming chemical that infuses the mix with a homogeneous cellular structure.

**fine aggregate**

Aggregate consisting of sand having a particle size smaller than 1/4 in. (6.4 mm); specif. the portion of aggregate that will pass through a 3/8 in. (9.5 mm) sieve, almost entirely through a No. 4 (4.8 mm) sieve, and be predominantly retained on a No. 200 (74µ) sieve.

**coarse aggregate**

Aggregate consisting of crushed stone, gravel, or blast-furnace slag having a particle size larger than 1/4 in. (6.4 mm); specif. the portion of aggregate that is retained on a No. 4 (4.8 mm) sieve. The maximum size of coarse aggregate in reinforced concrete is limited by the size of the section and the spacing of the reinforcing bars.

**graded aggregate**

Aggregate having a particle-size distribution characterized by uniform grading. Graded aggregate requires the least amount of cement paste to fill the voids and surround the particles.

**particle-size distribution**

The range of particle sizes in a granular material, expressed either as the cumulative percentage by weight of particles smaller or larger than a specified sieve opening, or as the percentage by weight of the particles that range between specified sieve openings.

**uniform grading**

A particle-size distribution in which aggregate particles vary uniformly from fine to coarse without a preponderance of any one size or group of sizes.

**expanded shale**

A strong lightweight aggregate obtained by the exfoliation of clay or shale. Also called **expanded clay**.

**expanded slate**

A strong lightweight aggregate obtained by the exfoliation of slate.

**exfoliation**

The splitting or swelling of certain minerals into a scaly aggregate when heated.

**perlite**

A volcanic glass expanded by heat to form lightweight, spherical particles, used as nonstructural lightweight aggregate and as loose-fill thermal insulation. Also, **pearlite**.

**vermiculite**

Mica expanded by heat into very light, wormlike threads, used as nonstructural lightweight aggregate and as loose-fill thermal insulation.



**admixture**

Any substance other than cement, water, or aggregate, added to a concrete or mortar mix to alter its properties or those of the hardened product. Also called **additive**.

- **air-entraining agent**  
An admixture that disperses entrained air in a concrete or mortar mix to increase workability, improve resistance of the cured product to the cracking induced by freeze-thaw cycles or the scaling caused by deicing chemicals, and in larger amounts, to produce lightweight insulating concrete.
- **accelerator**  
An admixture that hastens the setting and strength development of a concrete, mortar, or plaster mix.
- **retarder**  
An admixture that slows the setting of a concrete, mortar, or plaster mix in order to allow more time for placing and working the mix.
- **surface-active agent**  
An admixture for reducing the surface tension of the mixing water in a concrete mix, thereby facilitating the wetting and penetrating action of the water or aiding in the emulsifying and dispersion of other additives in the mix. Also called **surfactant**.
- **water-reducing agent**  
An admixture for reducing the amount of mixing water required for the desired workability of a concrete or mortar mix. Lowering the water-cement ratio in this manner generally results in increased strength. Also called **superplasticizer**.
- **coloring agent**  
A pigment or dye added to a concrete mix to alter or control its color.

**mix design**

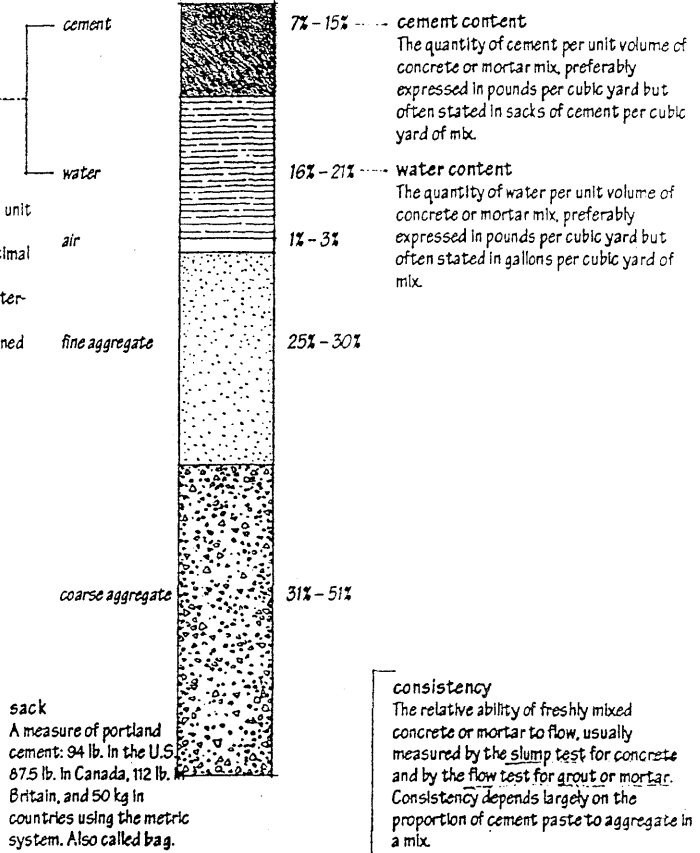
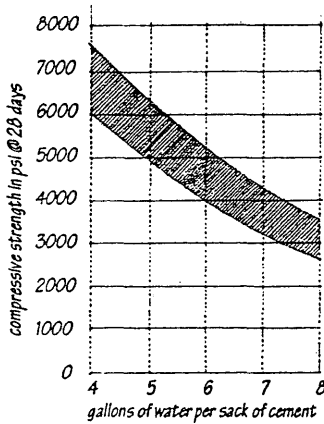
The most economical selection and proportioning of cement, water, and aggregate to produce concrete or mortar having the required properties of workability, strength, durability, and watertightness.

**Abram's law**

A law postulating that, with given concrete materials, curing, and testing conditions, the compressive strength of concrete is inversely proportional to the ratio of water to cement; developed by D.A. Abrams in 1919 from experiments at Lewis Institute in Chicago.

**water-cement ratio**

The ratio of mixing water to cement in a unit volume of concrete or mortar mix, preferably expressed by weight as a decimal fraction but often stated in gallons of water per 94-lb. sack of cement. The water-cement ratio controls the strength, durability, and watertightness of hardened concrete.

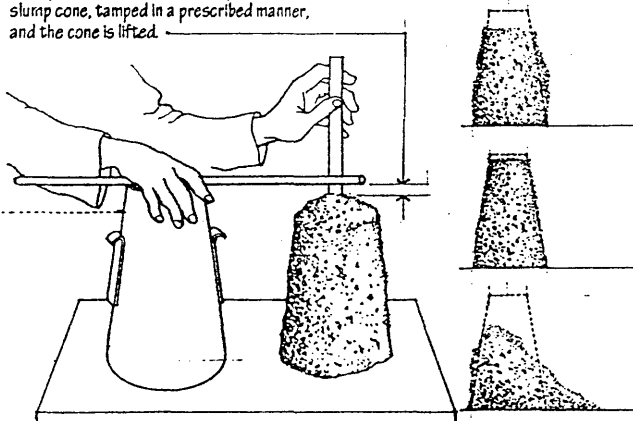


**slump test**

A method for determining the consistency and workability of freshly mixed concrete by measuring the slump of a test specimen.

**slump**

A measure of the consistency and workability of freshly mixed concrete, expressed as the vertical settling, in inches, of a specimen after it has been placed in a slump cone, tamped in a prescribed manner, and the cone is lifted.



**consistency**

The relative ability of freshly mixed concrete or mortar to flow, usually measured by the slump test for concrete and by the flow test for grout or mortar. Consistency depends largely on the proportion of cement paste to aggregate in a mix.

**workability**

The relative ease with which freshly mixed concrete or mortar can be handled, placed in formwork, compacted, and finished. Workability depends partly on the water-cement ratio and partly on the grading of the aggregate in a mix.

**plastic mix**

A concrete or mortar mix that flows sluggishly without segregating and is readily molded.

**dry mix**

A concrete or mortar mix containing little water or too much aggregate in relation to the other components and having little or no slump. Also called stiff mix.

**wet mix**

A concrete or mortar mix having a relatively high water content and runny consistency, yielding a product that is low in strength, durability, and watertightness.

**slump cone**

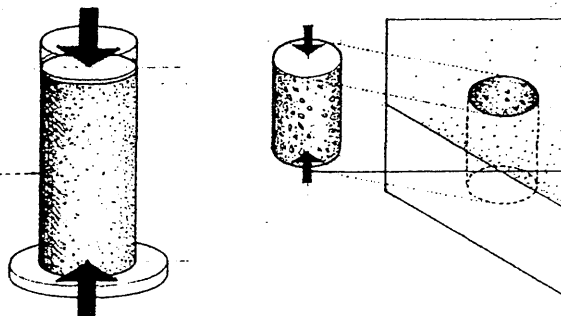
An open-ended, truncated cone of sheet metal 12 in. (305 mm) high, with a base diameter of 8 in. (203 mm) and a top diameter of 4 in. (102 mm), used to mold a specimen of freshly mixed concrete for the slump test.

**compression test**

A test for determining the compressive strength of a concrete batch, using a hydraulic press to measure the maximum load a test cylinder can support in axial compression before fracturing.

**test cylinder**

A cylinder of concrete 6 in. (152 mm) in diameter and 12 in. (305 mm) high, cast from a representative batch and cured in a laboratory or in the field under controlled conditions.



**core test**

A compression test of a cylinder cut from a hardened concrete structure, usually by means of a core drill.

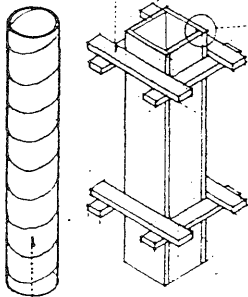
**form liner**  
Material for lining the inside face of a form, specially selected to impart a smooth or patterned finish to the concrete surface.

**release agent**  
Any of various materials, as oil or silicone, for preventing the bonding of concrete to a surface. Also called parting compound.

**bulkhead**  
A partition closing the end of a form or preventing the passage of newly placed concrete at a construction joint.

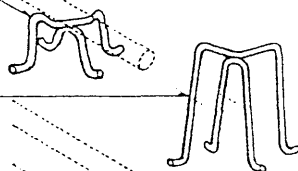
**keyway**  
A longitudinal groove or channel formed in a concrete footing or other member that has set, providing a shear-resisting key for newly placed concrete.

**yoke**  
A clamping device for keeping column forms or the tops of wall forms from spreading under the fluid pressure of newly placed concrete.



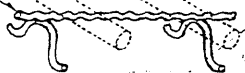
**Sonotube**  
Trademark for a brand of cylindrical column form made of compressed, resin-impregnated paper.

**chair**  
A device for supporting and holding steel reinforcement in proper position before and during the placing of concrete.



**high chair**  
A tall chair for supporting top bars in a concrete beam or slab.

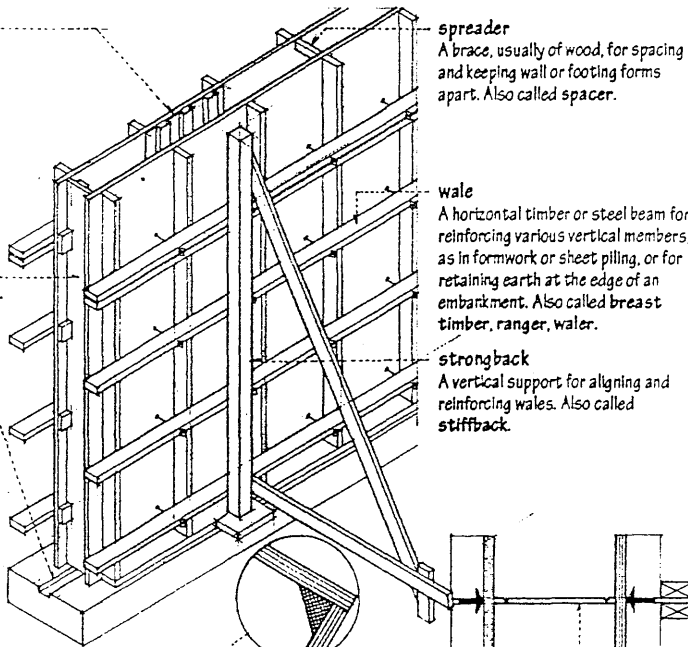
**bolster**  
A wide chair for supporting and spacing bottom bars in a concrete beam or slab.



**climbing form**  
A form that can be raised vertically for succeeding lifts of concrete during the construction of a multistory building.

**lift**  
The height of a quantity of concrete placed in a form at one time.

**slip form**  
A form that can be moved slowly and continuously as concrete is being placed during the construction of a concrete pavement or building.



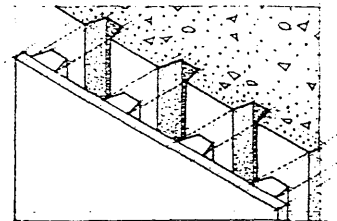
**spreader**  
A brace, usually of wood, for spacing and keeping wall or footing forms apart. Also called spacer.

**wale**  
A horizontal timber or steel beam for reinforcing various vertical members, as in formwork or sheet piling, or for retaining earth at the edge of an embankment. Also called breast timber, ranger, walr.

**strongback**  
A vertical support for aligning and reinforcing wales. Also called stiffback.

**formwork**  
The temporary structure required to support newly placed concrete, including the forms and all necessary supporting members, bracing, and hardware.

**form**  
Boarding or sheeting of wood, metal, plastic, or fiberglass for containing and giving a desired shape to newly placed concrete until it sets and gains sufficient strength to be self-supporting.



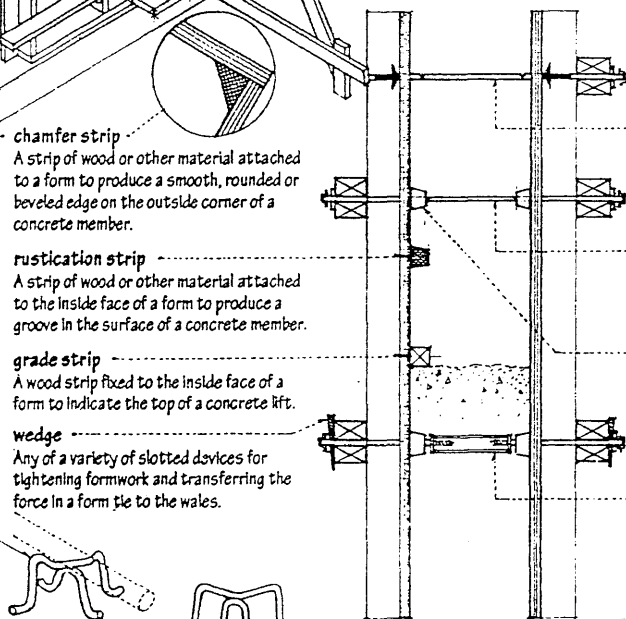
**form tie**  
A metal tie for keeping wall forms from spreading under the fluid pressure of newly placed concrete.

**snap tie**  
A form tie having notches or crimps which allow its ends to be snapped off below the concrete surface after stripping of the forms.

**cone bolt**  
A form tie having cones at each end inside the forms which allow it to also serve as a spreader.

**cone**  
A small, truncated cone of wood, steel, or plastic attached to a form tie to space and spread wall forms, leaving a neatly finished depression in the concrete surface to be filled or left exposed.

**she bolt**  
A form tie consisting of water rods which are inserted through the form and threaded onto the ends of an inner rod. After stripping, the water rods are removed while the inner rod remains in the concrete.

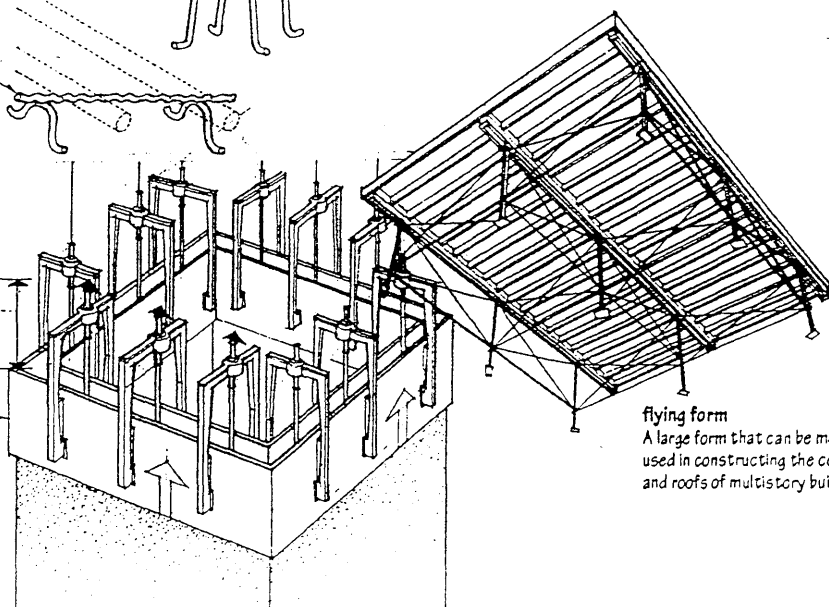


**chamfer strip**  
A strip of wood or other material attached to a form to produce a smooth, rounded or beveled edge on the outside corner of a concrete member.

**rustication strip**  
A strip of wood or other material attached to the inside face of a form to produce a groove in the surface of a concrete member.

**grade strip**  
A wood strip fixed to the inside face of a form to indicate the top of a concrete lift.

**wedge**  
Any of a variety of slotted devices for tightening formwork and transferring the force in a form tie to the wales.



**flying form**  
A large form that can be moved by a crane, used in constructing the concrete floors and roofs of multistory buildings.

# CONCRETE

## cast-in-place concrete

Concrete deposited, formed, cured, and finished in its final position as part of a structure. Also called cast-in-situ concrete.

## time of haul

The period from first contact between mixing water and cement to completion of discharge of the freshly mixed concrete from a truck mixer.

## ready-mixed concrete

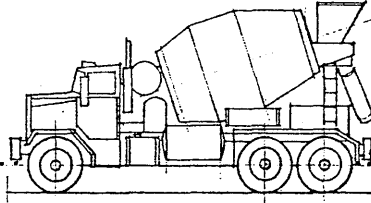
Concrete mixed at a batch plant for delivery by an agitator truck to a construction site.

## shrink-mixed concrete

Concrete partially mixed at a batch plant and then mixed more completely in a truck mixer en route to a construction site.

## transit-mixed concrete

Concrete dry batched at a batch plant and mixed in a truck mixer en route to a construction site.

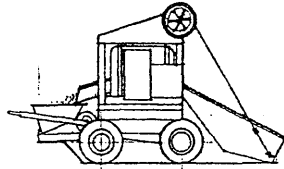


## agitator truck

A truck equipped with a rotating drum to prevent segregation or loss of plasticity of the ready-mixed concrete being delivered to a construction site.

## truck mixer

A truck equipped with a rotating drum and a separate water tank for mixing concrete en route to a construction site.



## concrete mixer

A machine having a revolving drum, often motor-driven, for mixing cement, aggregate, and water to produce concrete.

## buggy

A cart, often motor-driven, for transporting heavy materials, as freshly mixed concrete, for short distances at a construction site.

## placement

The process of depositing and consolidating freshly mixed concrete in a form or in the final position where it is to harden.

## direct placement

The discharging of freshly mixed concrete directly into a form from a concrete mixer, buggy, or crane bucket.

## free fall

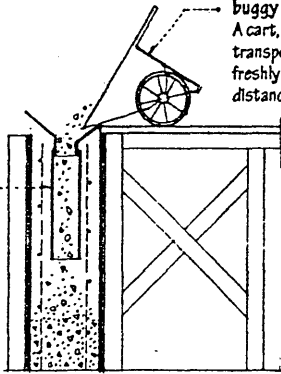
The descent of freshly mixed concrete into a form without the aid of a drop chute.

## drop chute

A chute for containing and directing a falling stream of freshly mixed concrete so as not to cause segregation.

## chute

An inclined trough or tube for conveying free-flowing materials to a lower level by gravity.

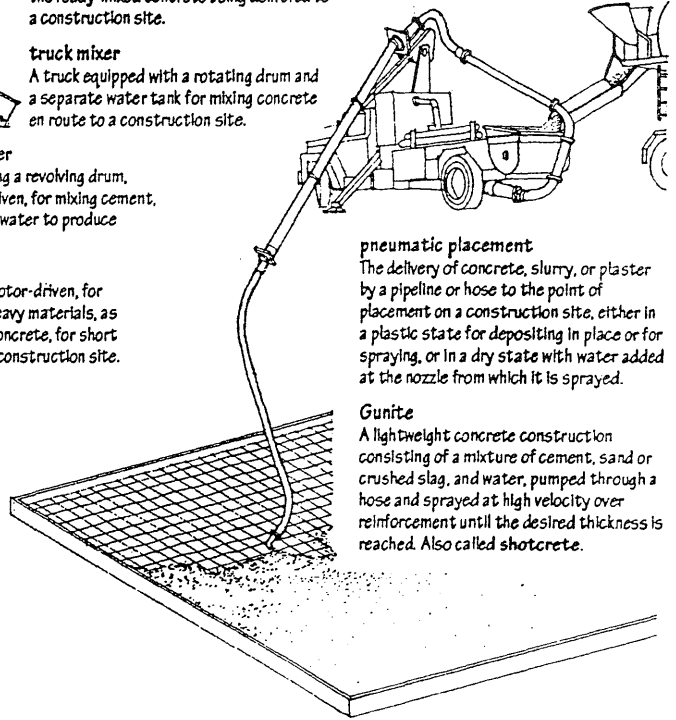


## pneumatic placement

The delivery of concrete, slurry, or plaster by a pipeline or hose to the point of placement on a construction site, either in a plastic state for depositing in place or for spraying, or in a dry state with water added at the nozzle from which it is sprayed.

## Gunite

A lightweight concrete construction consisting of a mixture of cement, sand or crushed slag, and water, pumped through a hose and sprayed at high velocity over reinforcement until the desired thickness is reached. Also called shotcrete.



## consolidation

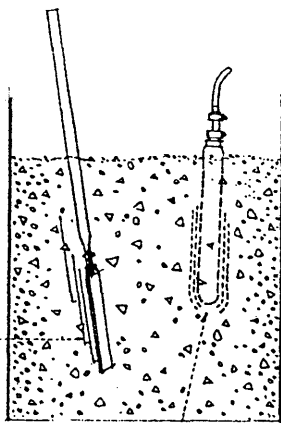
The process of eliminating voids other than entrained air within newly placed concrete and ensuring close contact of the concrete with form surfaces and embedded reinforcement.

## spading

Consolidation of newly placed concrete by the repeated insertions and withdrawals of a flat, spadelike tool.

## rodding

Consolidation of newly placed concrete by the repeated insertions and withdrawals of a rod.

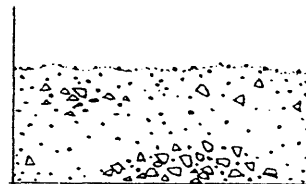


## vibration

Consolidation of newly placed concrete by the moderately high-frequency oscillations of a vibrator.

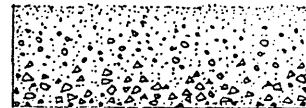
## vibrator

An electric or pneumatic oscillating tool for agitating and consolidating newly placed concrete.



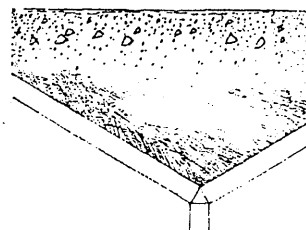
## segregation

The separation of coarse aggregate from the mortar or of water from the other ingredients of freshly mixed concrete, resulting from excessive horizontal movement or free fall of the mix, or from overvibration after placement.



## stratification

The separation of an excessively wet or overvibrated concrete mix into horizontal layers with increasingly lighter material migrating toward the top.



## bleeding

The emergence of excess mixing water on the surface of newly placed concrete, caused by settlement of solids within the mass. Also called water gain.

## laitance

A milky deposit containing cement and aggregate fines on the surface of new concrete, caused by the bleeding of excess mixing water, overworking of the mix, or improper finishing.

**finishing**

The process of leveling, smoothing, compacting, and treating a newly placed concrete surface to produce the desired texture and appearance.

**screed**

A wooden or metal straightedge drawn over a newly placed concrete slab to bring it to proper level.

**screed**

A firmly established grade strip or edge form serving as a guide for making a true level surface on a newly placed concrete slab.

**float**

A flat tool for spreading and smoothing a fresh concrete, stucco, or plaster surface.

**bull float**

A float having a large, flat blade attached to a long handle.

**darby**

A long wooden or metal straightedge for smoothing a fresh concrete surface immediately after screeding.

**dry-shake finish**

A colored finish produced by sprinkling a dry mixture of cement, sand, and a pigment on a fresh concrete surface following screeding and after any free water has evaporated, and then working the mixture into the surface with a float.

**float finish**

A fine-textured finish obtained by smoothing a fresh concrete, plaster, or stucco surface with a wood float.

**broom finish**

A striated finish obtained by stroking a broom or stiff brush over a freshly troweled concrete surface.

**trowel**

Any of various flat-bladed hand tools for applying, spreading, working, or smoothing plastic material, as concrete, mortar, and plaster.

**power trowel**

A portable machine having steel trowels mounted on radial arms that rotate about a vertical shaft to smooth, compact, and finish a fresh concrete surface.

**edger**

A trowel having a long, curved lip for rounding the edges of a fresh concrete slab as it begins to set.

**pavement saw**

A wheel-mounted, rotary power saw equipped with a silicon-carbide or diamond blade for cutting a control joint in a hardened concrete slab.

**trowel finish**

A dense, smooth finish obtained by working a fresh concrete or plaster surface with a steel trowel.

**swirl finish**

A textured finish given to a fresh plaster or concrete surface by troweling with a circular, overlapping motion.

**set**

The assumption of a rigid or hard state by concrete, mortar, plaster, or glue due to a physical or chemical change.

**cure**

To maintain newly placed concrete or mortar at the required temperature and humidity for the first seven days following placement, casting, or finishing to ensure satisfactory hydration of the cementitious materials and proper hardening.

**heat of hydration**

The heat generated by the process of hydration, as during the setting and curing of a concrete mix.

**hydration**

The process in which a substance combines chemically with water, as that occurring when cement is mixed with water.

**architectural concrete**

Exposed concrete work requiring special care in the selection of materials, forming, placing, and finishing to acquire the desired appearance.

**béton brut**

Concrete left in its natural state after formwork is removed, esp. when the concrete surface reflects the texture, joints, and fasteners of a board form.

**exposed aggregate finish**

A decorative finish produced by sandblasting, etching with an acid, or scrubbing a concrete surface after the initial set in order to remove the outer layer of cement paste and expose the aggregate.

**bushhammered finish**

A coarse-textured finish obtained by fracturing a concrete or stone surface with a power-driven hammer having a rectangular head with a corrugated, serrated, or toothed face.

**honeycomb**

Voids on a formed concrete surface, caused by segregation during placement or by insufficient consolidation.

**spalling**

The chipping or scaling of a hardened concrete or masonry surface caused by freeze-thaw cycles or the application of deicing salts. Also called scaling.

**crazing**

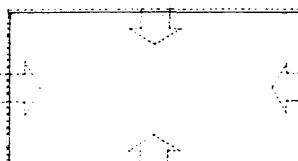
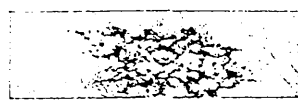
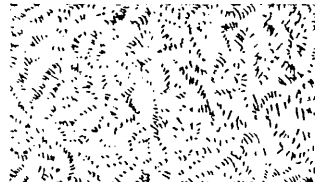
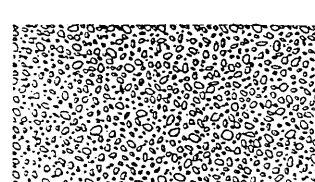
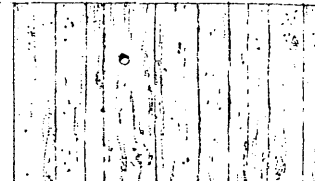
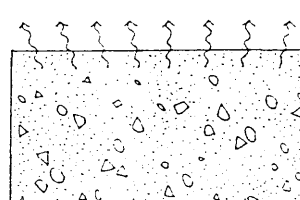
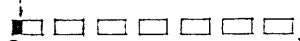
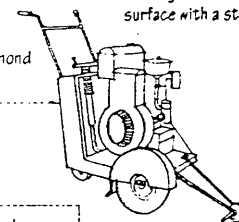
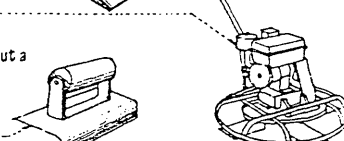
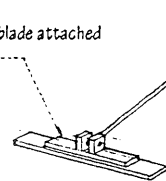
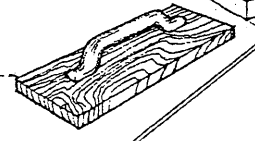
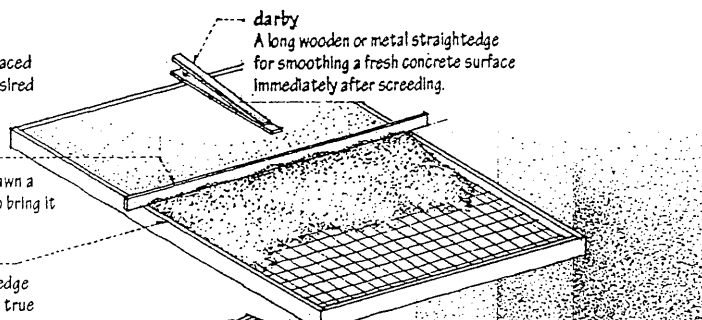
Numerous hairline cracks occurring in the surface of a newly hardened concrete slab as a result of rapid drying shrinkage.

**drying shrinkage**

A reduction in volume of concrete, mortar, or plaster caused by a loss of moisture.

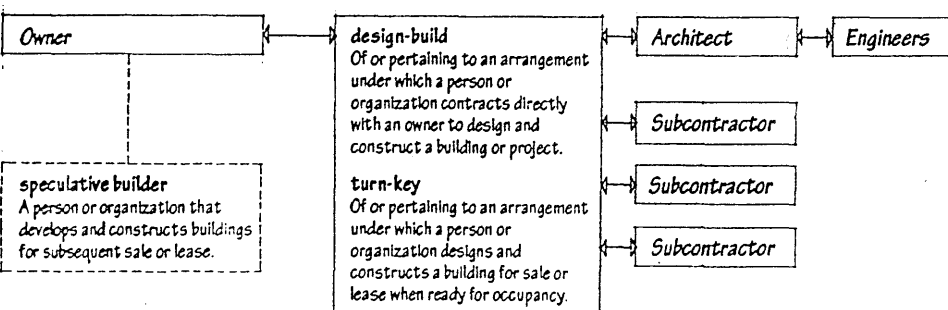
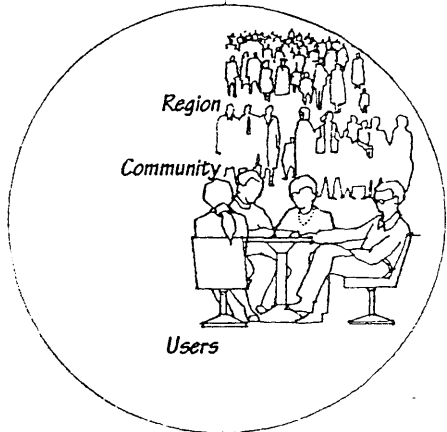
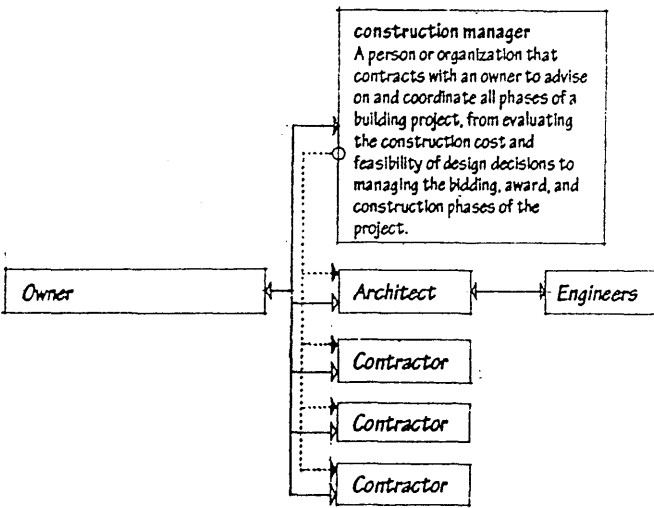
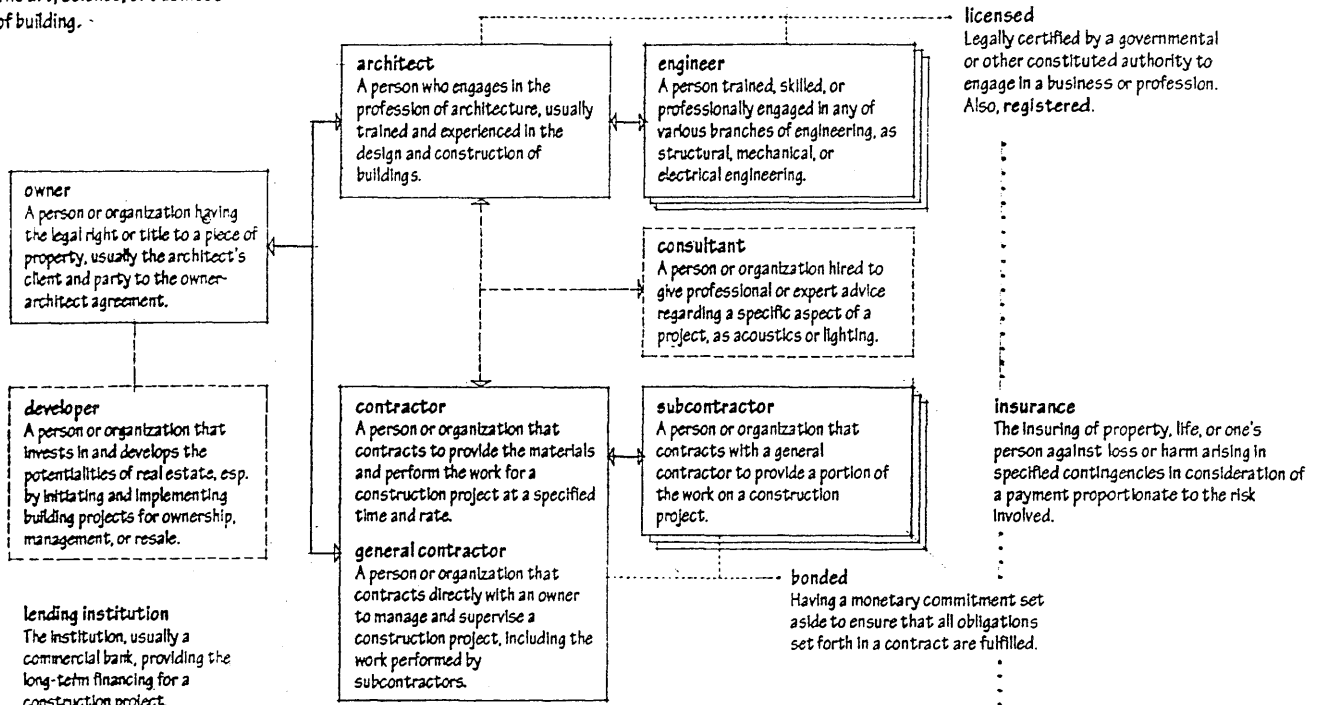
**setting shrinkage**

A reduction in volume of concrete prior to its final set, caused by hydration of the cement paste.



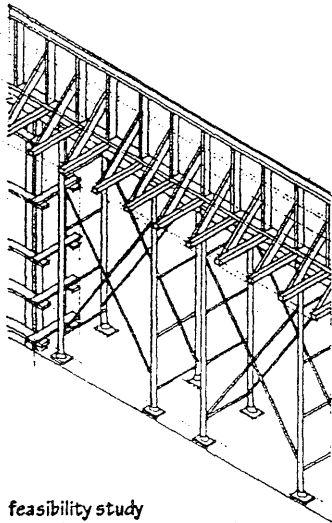
# CONSTRUCTION

The art, science, or business of building.





The process of building, from site preparation through erection, assembly, and finishing operations.

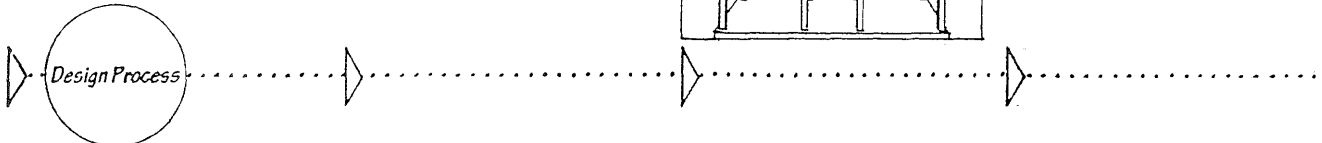
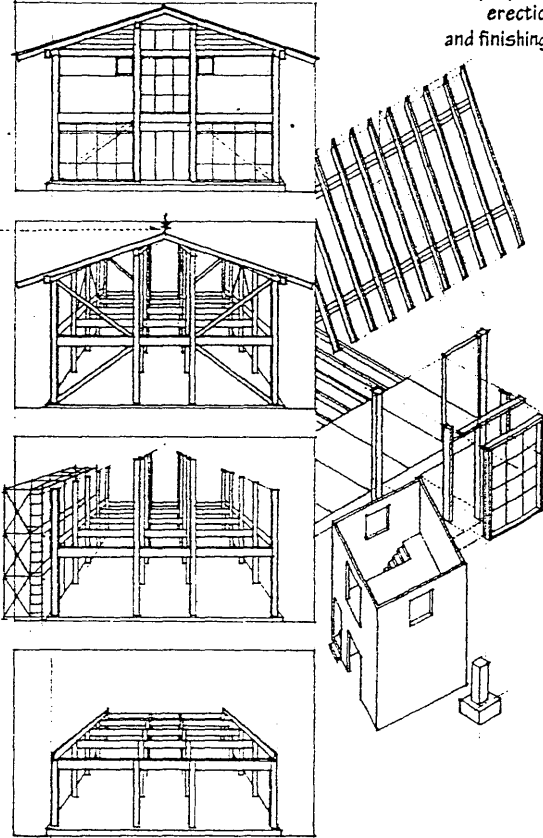


**top out**  
To install the highest structural member in a construction or complete the uppermost course in a masonry wall.

**falsework**  
The temporary framework for supporting a structure under construction that is not yet capable of supporting itself.

**scaffold**  
A temporary structure or platform for supporting workers and materials at a height above the floor or ground during the construction or repair of a building. Also called staging.

**feasibility study**  
A detailed investigation and analysis conducted to determine the financial, technical, or other advisability of a proposed construction project.



**bidding**  
The competitive process of offering to perform the work described in a contract for a specified sum.

**award**  
A formal acceptance of a bid or a negotiated proposal.

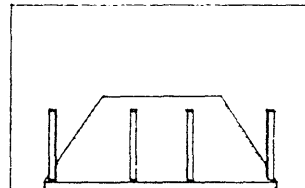
**contract**  
A legally enforceable agreement, usually in written form, between two or more parties to do or not to do something specified.

**notice to proceed**  
A written communication issued by an owner authorizing a contractor to proceed with the work and establishing the date of commencement of the work.

**building permit**  
A written authorization to proceed with construction of a building project in accordance with approved drawings and specifications, issued by the local government agency having jurisdiction after plans have been filed and reviewed.

**building official**  
A person designated by a governmental authority to administer and enforce the provisions of a building code.

**erect**  
To construct by the raising, positioning, fitting together, and fastening of materials or parts.

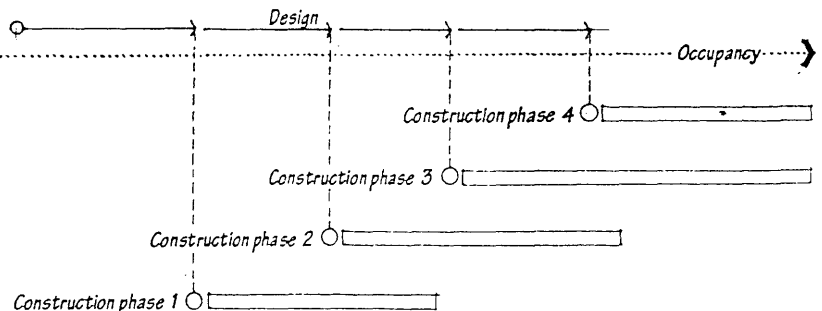


**certificate of occupancy**  
A document issued by a building official certifying that all or a designated portion of a building complies with the provisions of the building code, and permitting occupancy for its designated use.

**postoccupancy evaluation**  
The process of diagnosing the technical, functional and behavioral aspects of a completed building in order to accumulate information for future programming and design activities.

**fast-track**  
Of or pertaining to project scheduling in which the design and construction phases of a building project overlap to compress the total time required for completion.

**CPM**  
Critical Path Method: a method for planning, scheduling, and managing a project, combining all relevant information into a flow chart, including the optimum sequence and duration of activities, the relative significance of each event, and the coordination required for timely completion of the project.



# CONSTRUCTION

The manner in which materials are ordered, assembled, and united into a whole, as frame construction.

## systems building

A construction process using a high degree of prefabrication in the manufacture of standardized units or components to speed assembly and erection of a building. Also called industrialized building.

## panel

A prefabricated section of a floor, wall, ceiling, or roof, handled as a single unit in the assembly and erection of a building.

## sandwich panel

A structural panel consisting of a core of relatively light material enclosed between two sheets of a high-strength material, generally resulting in a high stiffness-to-weight ratio.

## stressed-skin panel

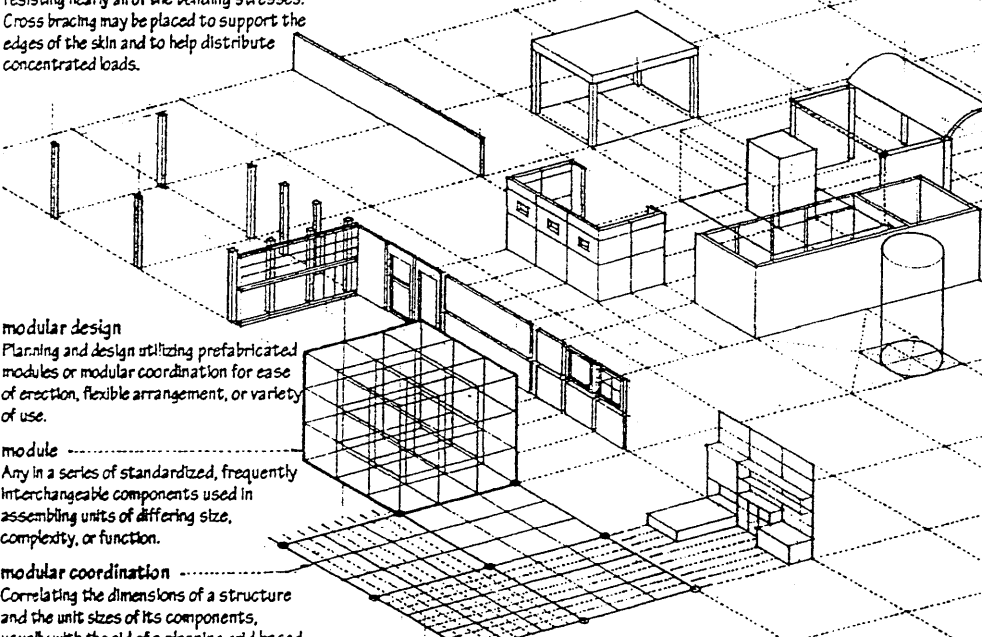
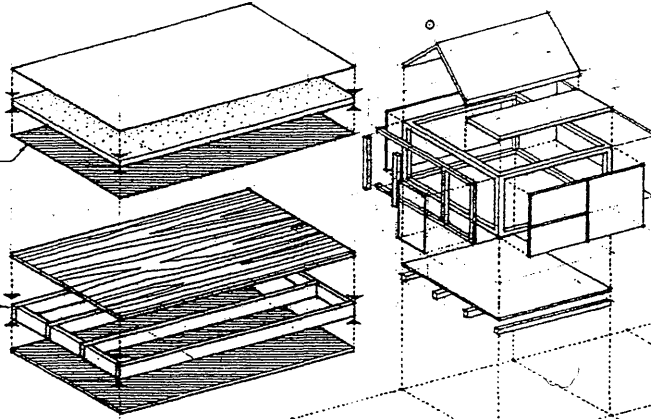
A structural panel consisting of plywood facings glued to lumber stringers, used as floor, roof, or wall member subject to bending. The plywood facings and stringers act as a series of I-beams with the plywood resisting nearly all of the bending stresses. Cross bracing may be placed to support the edges of the skin and to help distribute concentrated loads.

## prefabricate

To fabricate or manufacture beforehand, esp. in standardized units or components for quick assembly and erection.

## fabricate

To construct by assembling diverse and usually standardized parts.



## modular design

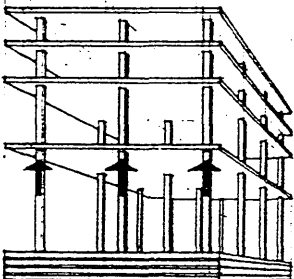
Planning and design utilizing prefabricated modules or modular coordination for ease of erection, flexible arrangement, or variety of use.

## module

Any in a series of standardized, frequently interchangeable components used in assembling units of differing size, complexity, or function.

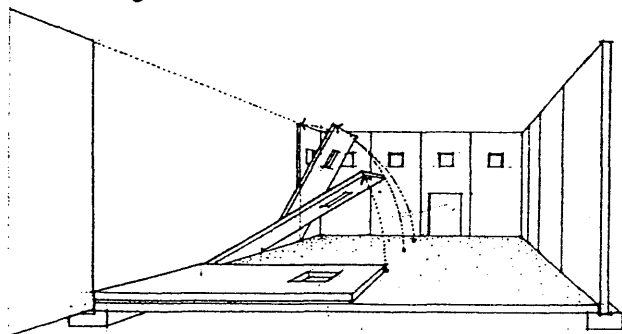
## modular coordination

Correlating the dimensions of a structure and the unit sizes of its components, usually with the aid of a planning grid based on a 4-inch or 100-mm cubical module.



## lift-slab construction

A technique of constructing multistory buildings in which all horizontal slabs are cast at ground level and, when cured, are raised into position by hydraulic jacks.



## tilt-up construction

A method of casting reinforced concrete wall panels on site in a horizontal position, then tilting them up into their final position.

## contract documents

The legal documents comprising a construction contract, including the owner-contractor agreement, conditions of the contract, and the construction drawings and specifications for the project, including all addenda, modifications, and any other items stipulated as being specifically included.

## construction documents

The construction drawings and specifications setting forth in detail the requirements for the construction of a project.

## specifications

The part of the contract documents consisting of a detailed description of the technical nature of the materials, standards, and quality of execution of the work to be placed under contract.

## uniform system

A format developed by the Construction Specifications Institute for coordinating specifications, filling of technical data and product literature, and construction cost accounting, organized into 16 divisions based on an interrelationship of material, trade, or function. Also called Masterformat.

Division 1 General Requirements

Division 2 Sitework

Division 3 Concrete

Division 4 Masonry

Division 5 Metals

Division 6 Wood & Plastics

Division 7 Thermal & Moisture Protection

Division 8 Doors & Windows

Division 9 Finishes

Division 10 Specialties

Division 11 Equipment

Division 12 Furnishings

Division 13 Special Construction

Division 14 Conveying Systems

Division 15 Mechanical

Division 16 Electrical

## performance specification

A specification that stipulates how a particular component or system must perform without giving the means to be employed to achieve the results.

## descriptive specification

A specification that stipulates the exact quantities and qualities of materials to be furnished and how they are to be assembled in a construction.

## reference specification

A specification that refers to a standard specification to indicate the properties desired in a material or component and the methods of testing required to substantiate the performance of products.

## proprietary specification

A specification that stipulates the use of specific products, systems, or processes without provision for substitution.

**building code**

A code regulating the design, construction, alteration, and repair of buildings, adopted and enforced by a local government agency to protect the public safety, health, and welfare.

A building code generally establishes minimum standards for materials and methods of construction, specifications for structural and fire safety, and other requirements based on the type of construction and the occupancy of a building, often using standards established by the American Society for Testing and Materials (ASTM), the American National Standards Institute (ANSI), and various technical societies and trade associations.

**model code**

A building code developed by an organization of states, professional societies, and trade associations for adoption by local communities.

**BOCA National Building Code**

A building code developed and published by the Building Officials and Code Administrators International, Inc. (BOCA), and used primarily in the northeastern U.S.

**Uniform Building Code**

A building code developed and published by the International Conference of Building Officials (ICBO), and used primarily in the central and western U.S.

**Standard Building Code**

A building code developed and published by the Southern Building Code Conference (SBCC), and used primarily in the southeastern U.S.

**energy code**

A building code that sets minimum standards for energy conservation and the energy-efficient design of buildings.

**Americans with Disabilities Act**

An act of Congress that became law in 1992, establishing design standards and requirements for all buildings except single-family residences to ensure their accessibility by the physically disabled.

**zoning ordinance**

An ordinance regulating the division of land into zones, as to restrict the height, bulk, density, and use of buildings, and the provision of any ancillary facilities, as parking; a principal instrument in the implementation of a master plan. Also called zoning code.

**restrictive covenant**

A covenant with a clause that restricts the action of any party to it, as an agreement among property owners specifying the use to which a property can be put; racial and religious restrictions are legally unenforceable.

**nonconforming**

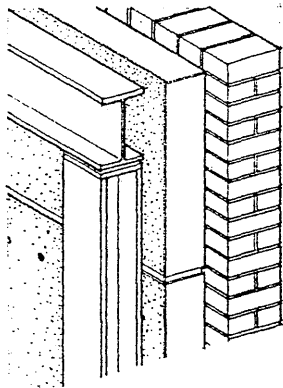
Of or pertaining to a material, type of construction, or occupancy or use not complying with the requirements set forth in a building code.

**variance**

An official permit to do something normally forbidden by regulations, esp. by building in a way or for a purpose normally forbidden by a building code or zoning ordinance.

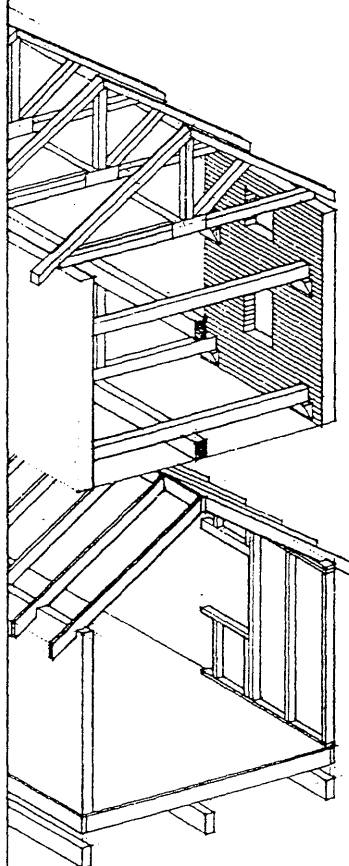
**noncombustible construction**

Construction having a structure of steel, concrete or masonry, and walls, floors and a roof of noncombustible materials.



**combustible construction**

Any construction that does not fulfill the requirements for noncombustible construction.

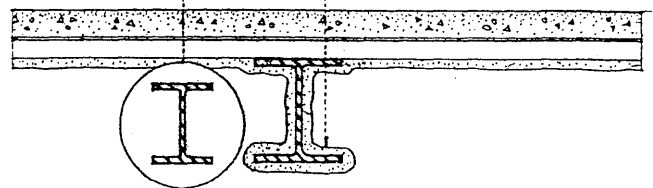


**protected noncombustible construction**

Noncombustible construction having a structure and major components with fire-resistance ratings at least equal to those specified by the appropriate authorities.

**unprotected noncombustible construction**

Noncombustible construction having no fire-resistance requirements except for fire walls and enclosures of fire exits and vertical shafts.



**construction type**

A classification of a building's construction according to the fire resistance of its major components: structural frame, exterior bearing and nonbearing walls, interior bearing walls, floors and ceilings, roofs, and enclosures of fire exits and vertical shafts. While each of the model codes differs in the detailed requirements for each construction type, they all limit the area and height of a building according to construction type and intended occupancy. Also called construction class.

**ordinary construction**

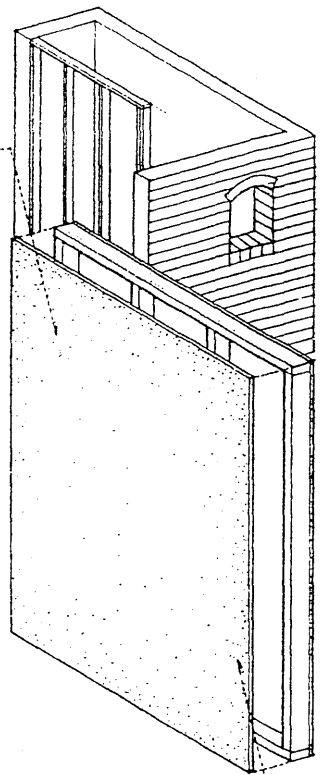
A construction type having noncombustible exterior walls and an interior structure wholly or partly of light wood framing.

**protected ordinary construction**

Ordinary construction having a structure and major components with fire-resistance ratings at least equal to those specified by the appropriate authorities.

**unprotected ordinary construction**

Ordinary construction having no fire-resistance requirements for the interior structure except for fire walls and enclosures of fire exits and vertical shafts.



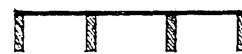
**heavy-timber construction**

A construction type having noncombustible exterior walls and an interior structure of timbers and decking of specified minimum sizes. Also called mill construction.



**light wood frame construction**

A construction type having a framework of wood members not meeting the requirements for heavy-timber construction.



**protected light wood frame construction**

Light wood frame construction having a structure and major components with fire-resistance ratings at least equal to those specified by the appropriate authorities.

**unprotected light wood frame construction**

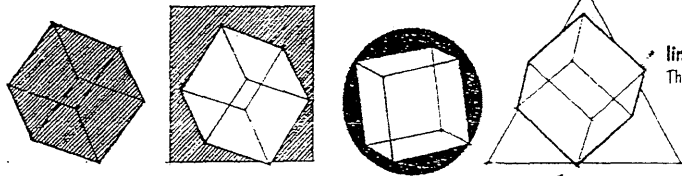
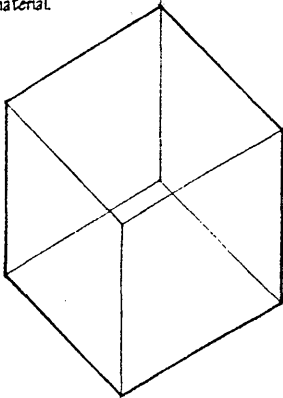
Light wood frame construction having no fire-resistance requirements except for fire walls and enclosures of fire exits and vertical shafts.

# DESIGN

The creation and organization of formal elements in a work of art.

## form

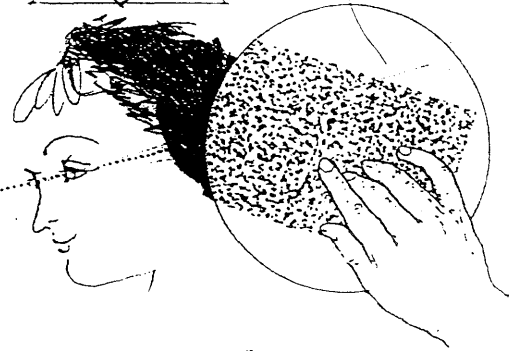
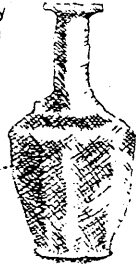
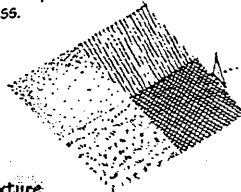
The shape and structure of something as distinguished from its substance or material.



**line**  
The edge or contour of a shape.

## shape

The outline or surface configuration of a particular form or figure. While form usually refers to the principle that gives unity to a whole, and often includes a sense of mass or volume, shape suggests an outline with some emphasis on the enclosed area or mass.



## texture

The visual and esp. tactile quality of a surface, apart from its color or form.

## visual texture

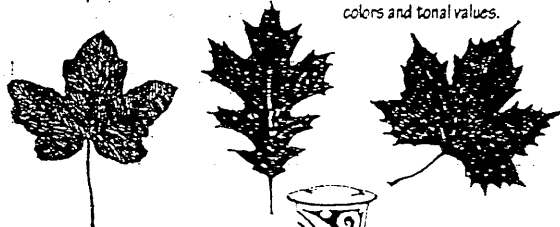
The apparent texture of a surface resulting from the combination and interrelation of colors and tonal values.

## tactile texture

The physical, dimensional structure of a surface, apart from its color or form.

## organic

Of or pertaining to shapes and forms having irregular contours which appear to resemble those of living plants or animals.

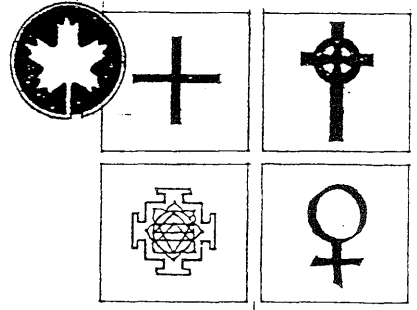
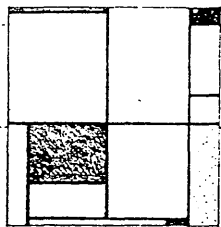


## nonobjective

Of or pertaining to shapes and forms not representing natural or actual objects. Also, *abrepresentational*.

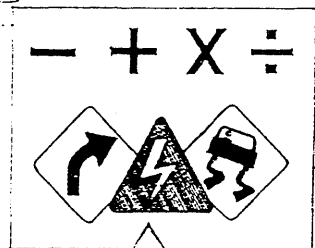
## geometric

Of or pertaining to shapes and forms which resemble or employ the simple rectilinear or curvilinear elements of geometry.



## abstract

Of or pertaining to shapes and forms having an intellectual and affective content dependent solely on their intrinsic lines, colors, and relationship to one another.



## symbol

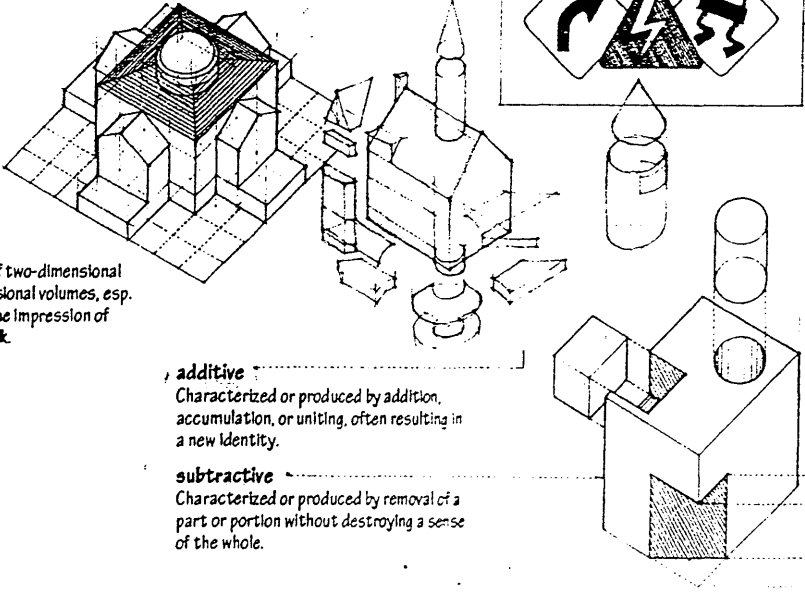
Something that stands for or represents something else by association, resemblance, or convention, deriving its meaning chiefly from the structure in which it appears.

## sign

A mark or figure having a conventional meaning and used in place of a word or phrase to express a complex notion.

## massing

A unified composition of two-dimensional shapes or three-dimensional volumes, esp. one that has or gives the impression of weight, density, and bulk.



## additive

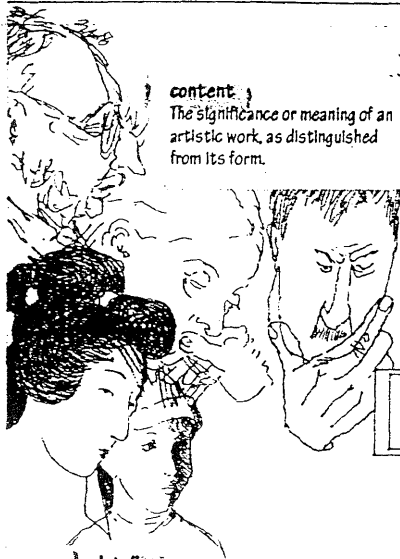
Characterized or produced by addition, accumulation, or uniting, often resulting in a new identity.

## subtractive

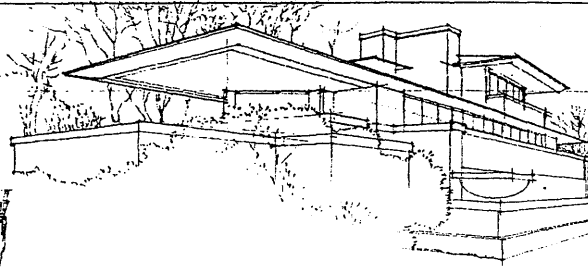
Characterized or produced by removal of a part or portion without destroying a sense of the whole.

## articulation

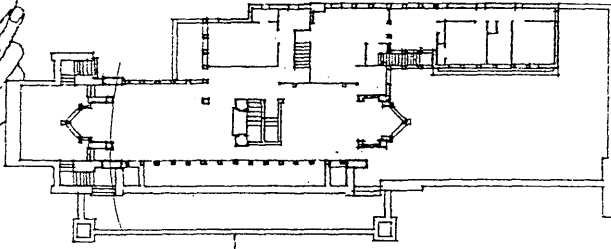
A method or manner of jointing that makes the united parts clear, distinct, and precise in relation to each other.



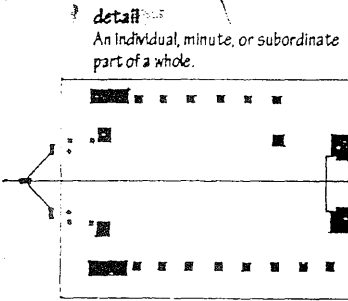
**content**  
The significance or meaning of an artistic work, as distinguished from its form.



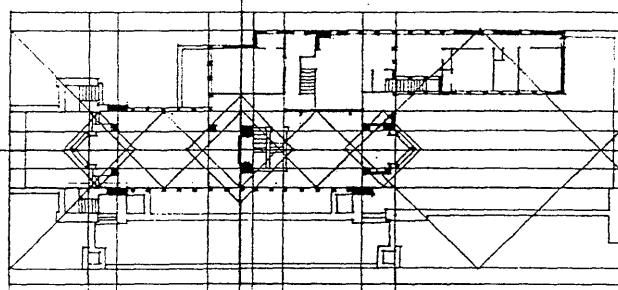
**form**  
The manner of arranging and coordinating the parts of a composition so as to produce a coherent image.



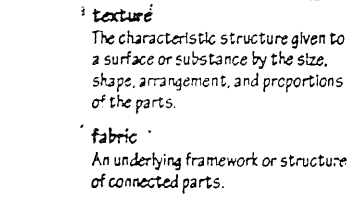
**organization**  
The systematic arranging of interdependent or coordinated parts into a coherent unity or functioning whole.



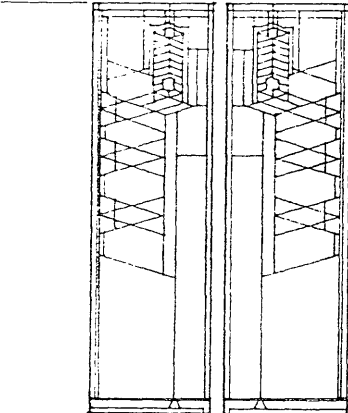
**detail**  
An individual, minute, or subordinate part of a whole.



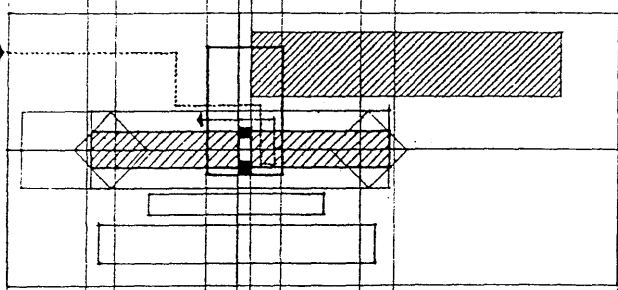
**structure**  
The organization of elements or parts in a complex system as dominated by the general character of the whole.



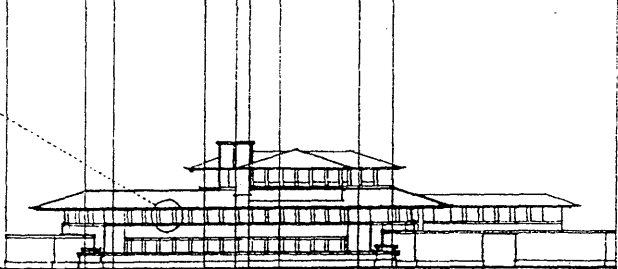
**texture**  
The characteristic structure given to a surface or substance by the size, shape, arrangement, and proportions of the parts.



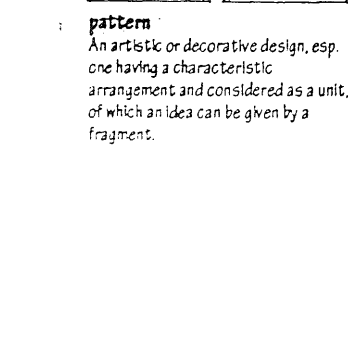
**fabric**  
An underlying framework or structure of connected parts.



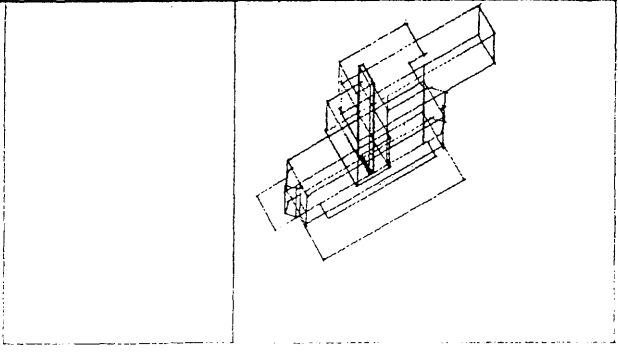
**part**  
The basic scheme or concept for an architectural design, represented by a diagram.



**diagram**  
A drawing, not necessarily representational, that outlines, explains, or clarifies the arrangement and relations of the parts of a whole.



**pattern**  
An artistic or decorative design, esp. one having a characteristic arrangement and considered as a unit, of which an idea can be given by a fragment.



**composition**  
The arranging of parts or elements into proper proportion or relation so as to form a unified whole.

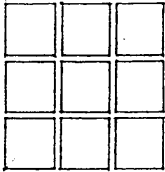
# DESIGN

## design principle:

A fundamental and comprehensive concept of visual perception for structuring an aesthetic composition.

## unity

The state or quality of being combined into one, as the ordering of elements in an artistic work that constitutes a harmonious whole or promotes a singleness of effect.



## uniformity

The state or quality of being identical, homogeneous, or regular.

## homogeneous

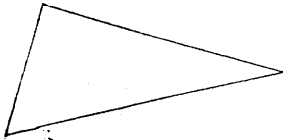
Uniform in structure throughout or composed of parts that are all of the same nature or kind.

## regular

Uniformly or evenly formed or arranged.

## monotony

The state or quality of lacking variety.



## variety

The state or quality of having varied or diverse forms, types, or characteristics.

## emphasis

Stress or prominence given to an element of a composition by means of contrast, anomaly, or counterpoint.

## contrast

Opposition or juxtaposition of dissimilar elements in a work of art to intensify each element's properties and produce a more dynamic expressiveness.

## anomaly

A deviation from the normal or expected form, order, or arrangement.

## point

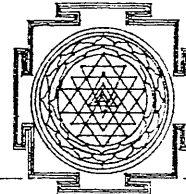
The major idea, essential part, or salient feature of a narrative or concept.

## salient

Prominent or conspicuous.

## order

A condition of logical, harmonious, or comprehensible arrangement in which each element of a group is properly disposed with reference to other elements and to its purpose.



## harmony

The orderly, pleasing, or congruent arrangement of the elements or parts in an artistic whole.

## repose

Harmony in the arrangement of parts or colors that is restful to the eye.

## coherent

Logically or aesthetically ordered or integrated to afford comprehension or recognition.

## agreement

Correspondence in shape, size, or color among the elements in a work of art.

## similarity

The state or quality of being alike in substance, essentials, or characteristics.

## proximity

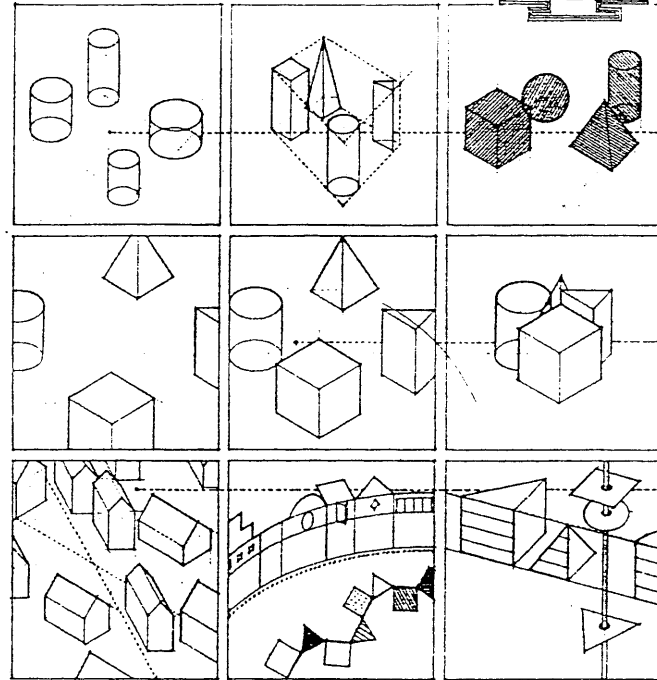
Nearness in place, order, or relation.

## continuity

The state or quality of being continuous, as a line, edge, or direction.

## alignment

Arrangement in or adjustment according to a straight line.

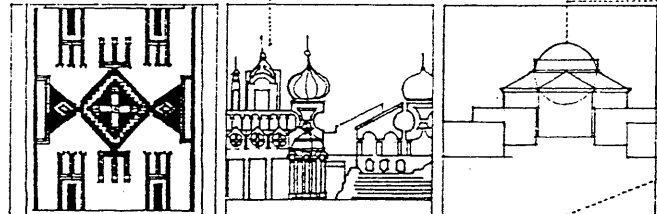


## complexity

The state or quality of being a whole composed of complicated, intricate, or interconnected parts.

## collage

An artistic composition of often diverse elements in unlikely or unexpected juxtaposition.



## hierarchy

A system of elements ranked, classified, and organized one above another, according to importance or significance.

## opposition

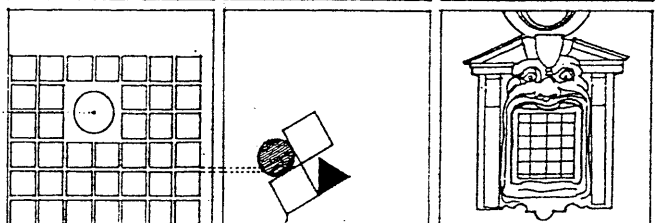
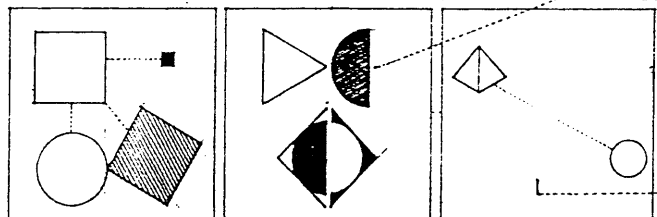
The state or position of being placed opposite another, or of lying in corresponding positions from an intervening space or object.

## juxtaposition

The state or position of being placed close together or side by side, so as to permit comparison or contrast.

## tension

A tenuous balance maintained in an artistic work between opposing forces or elements, often causing anxiety or excitement.

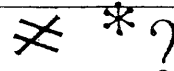


## counterpoint

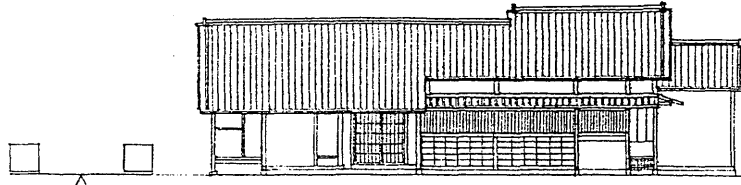
A parallel but contrasting element or theme in a narrative or concept.

## chaos

A state of utter disorder or confusion.

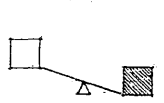


**equilibrium**  
A state of rest or balance between contrasting elements or opposing forces.

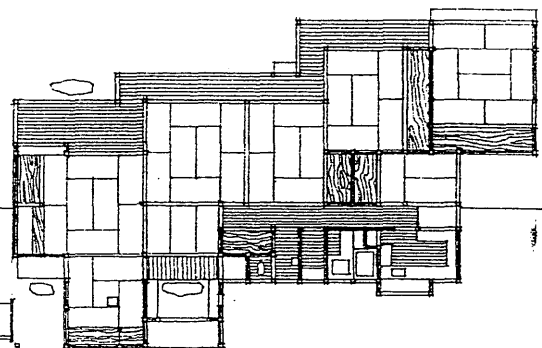
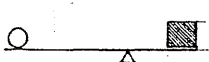


**balance**  
The pleasing or harmonious arrangement or proportion of parts or elements in a design or composition.

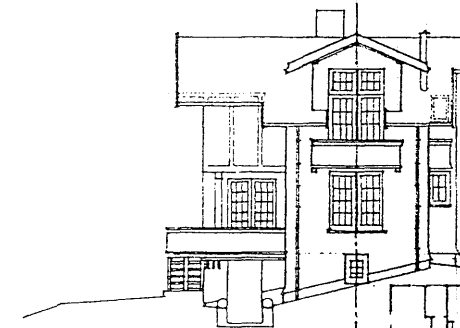
**equipoise**  
An equal distribution of weight, relationship, or forces.



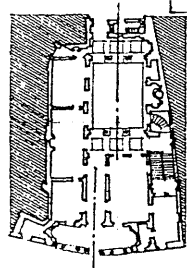
**counterpoise**  
A counterbalancing weight or force.



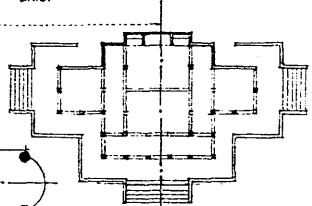
**symmetry**  
The exact correspondence in size, form, and arrangement of parts on opposite sides of a dividing line or plane, or about a center or axis.



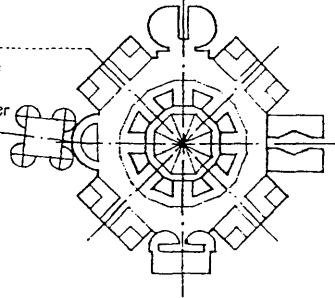
**local symmetry**  
A symmetrical condition occurring in one part of a design, often serving to center an irregular pattern.



**bilateral symmetry**  
Symmetry resulting from the arrangement of similar parts on opposite sides of a median axis.



**radial symmetry**  
Symmetry resulting from the arrangement of similar, radiating parts about a center point or central axis.



**axis**  
A straight line to which elements in a composition are referred for measurement or symmetry.

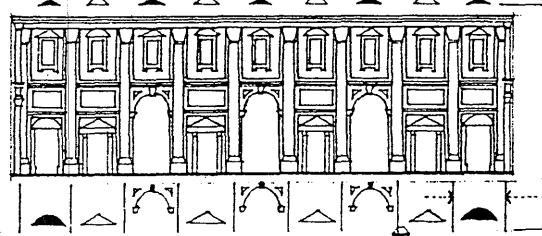
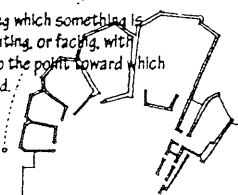
**axis of symmetry**  
An imaginary line about which a figure, body, or composition is symmetrical.

**movement**  
The rhythmic quality or character of a composition suggesting motion by represented gestures or by the relationship of structural elements.



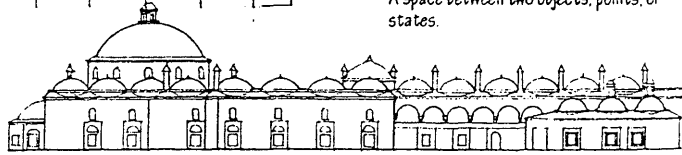
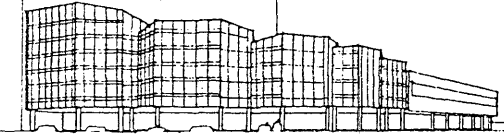
**rhythm**  
Movement characterized by a patterned repetition or alternation of formal elements or motifs in the same or a modified form.

**direction**  
The line along which something is moving, pointing, or facing, with reference to the point toward which it is directed.



**repetition**  
The act or process of repeating formal elements or motifs in a design.

**interval**  
A space between two objects, points, or states.



**gradation**  
A process or change taking place by degrees or through a series of gradual, successive stages.

**concatenation**  
A series of linked or interconnected things or events.

# DESIGN

## proportion

The comparative, proper, or harmonious relation of one part to another or to the whole with respect to magnitude, quantity, or degree.

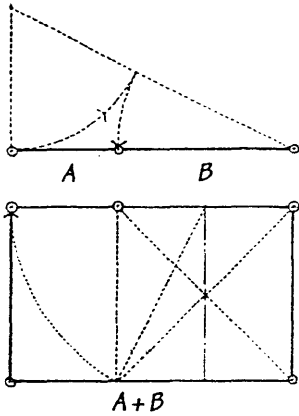
$$A/B = B/A+B$$

## proportion

The equality between two ratios in which the first of the four terms divided by the second equals the third divided by the fourth.

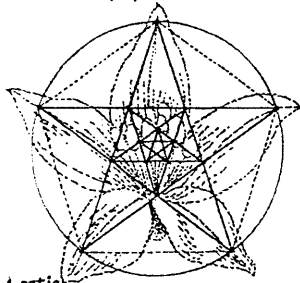
## golden section

A proportion between the two dimensions of a plane figure or the two divisions of a line, in which the ratio of the smaller to the larger is the same as the ratio of the larger to the whole: a ratio of approximately 0.618 to 1.000. Also called **golden mean**.

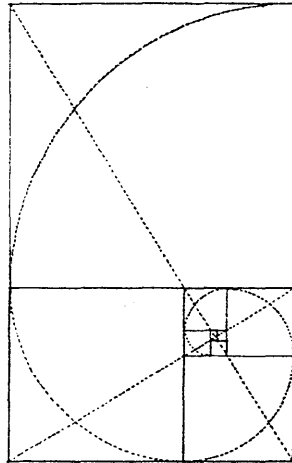


## eurythmy

Harmony of proportion or movement.



**ratio**  
Relation in magnitude, quantity, or degree between two or more similar things.



1, 1, 2, 3, 5, 8, 13, 21...

1/1, 1/2, 2/3, 3/5, 5/8, 8/13...

## Fibonacci series

The unending sequence of numbers where the first two terms are 1 and 1, and each succeeding term is the sum of the two immediately preceding. Also called **Fibonacci sequence**.

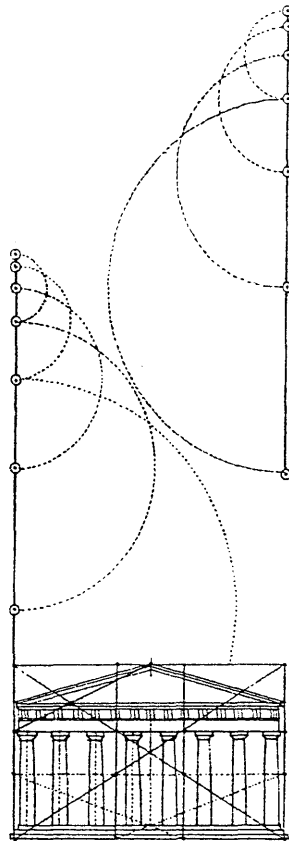
## harmonic series

A series in which the terms are in harmonic progression.

1, 1/3, 1/5, 1/7, 1/9

## harmonic progression

A sequence of numbers the reciprocals of which form an arithmetic progression.

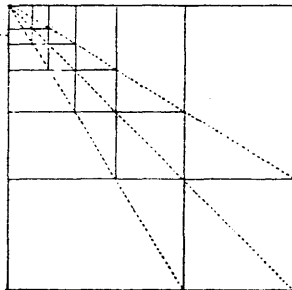


## scale

A certain proportionate size, extent, or degree, usually judged in relation to some standard or point of reference.

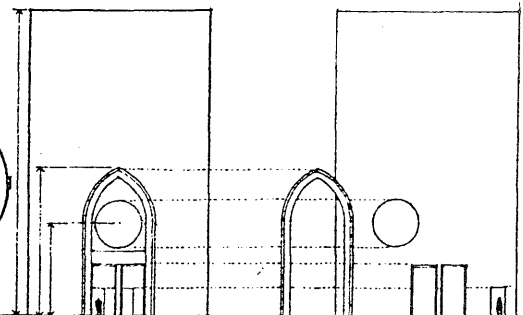
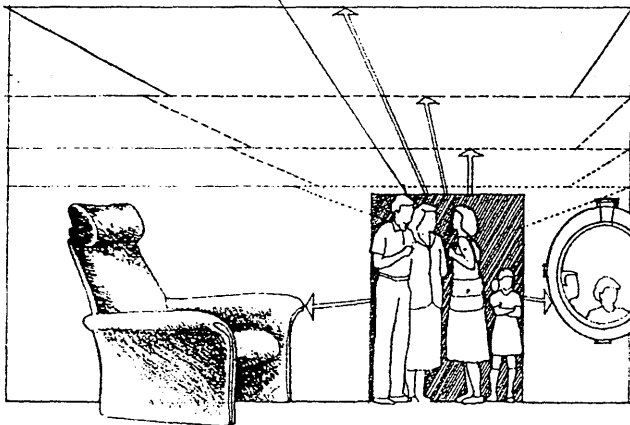
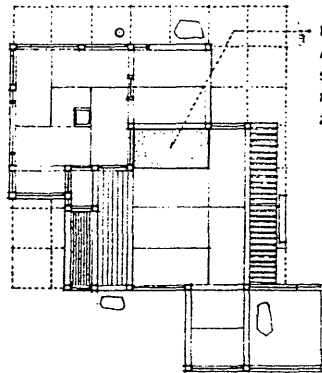
## human scale

The size or proportion of a building element or space, or an article of furniture, relative to the structural or functional dimensions of the human body.



## module

A unit of measurement used for standardizing the dimensions of building materials or regulating the proportions of an architectural composition.



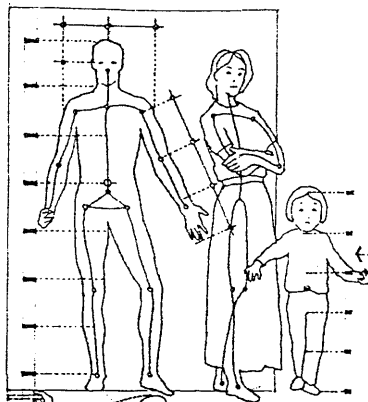
## mechanical scale

The size or proportion of something relative to an accepted standard of measurement.

## visual scale

The size or proportion a building element appears to have relative to other elements or components of known or assumed size.



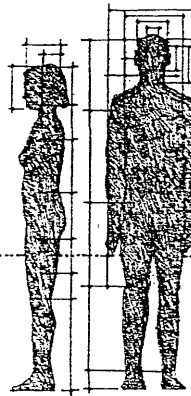


**structural dimension**

Any of the dimensions of the human body and its parts.

**functional dimension**

Any of the dimensions determined by bodily position and movement, as reach, stride, or clearance.



**ergonomics**

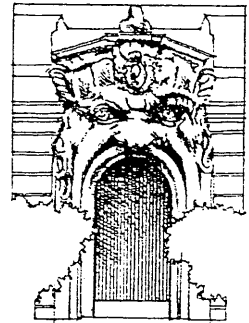
An applied science concerned with the characteristics of people that need to be considered in the design of devices and systems in order that people and things will interact effectively and safely. Also called **human engineering**.

**anthropometry**

The measurement and study of the size and proportions of the human body.

**anthropomorphize**

To ascribe human form or characteristics to nonhuman things or beings.



**kinesthesia**

The sensory experience of bodily position, presence, or movement derived chiefly from stimulation of nerve endings in muscles, tendons, and joints. Also, **kinaesthesia**, **kinesthesia**.

**haptic**

Relating to or based on the sense of touch.

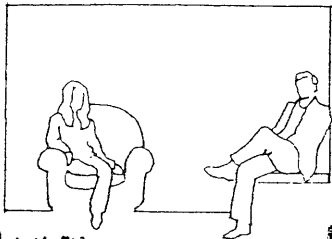
**olfactory**

Relating to or based on the sense of smell.



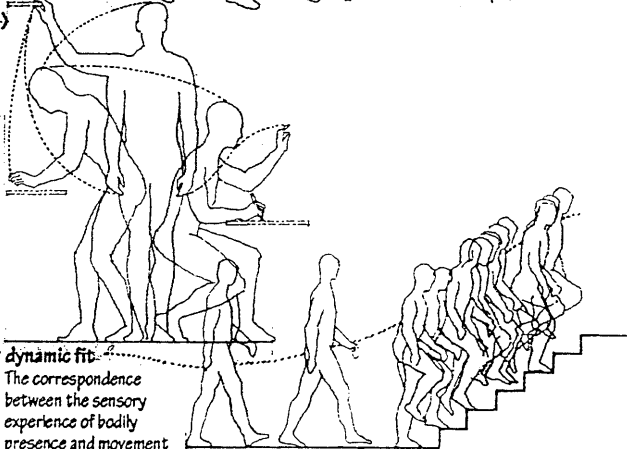
**proxemics**

The study of the symbolic and communicative role of the spatial separation individuals maintain in various social and interpersonal situations, and how the nature and degree of this spatial arrangement relates to environmental and cultural factors.



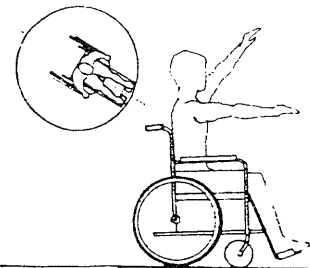
**static fit**

The correspondence between the size and posture of a human body and a building element or article of furniture.



**dynamic fit**

The correspondence between the sensory experience of bodily presence and movement and the size, shape, and proportion of a space.



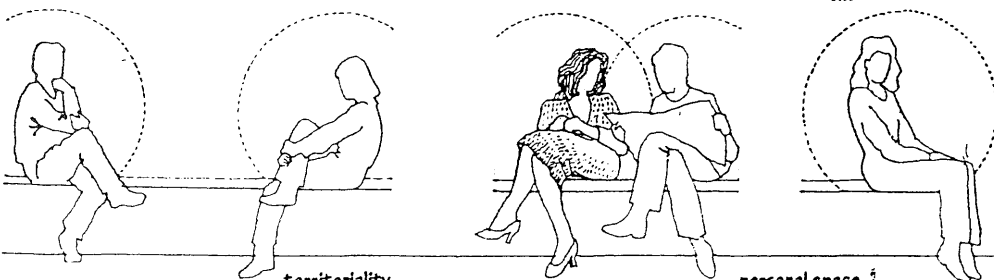
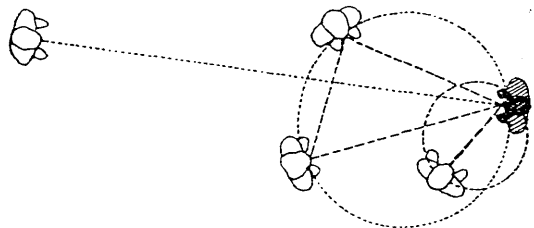
**barrier-free**

Of or pertaining to spaces, buildings, and facilities fully accessible and usable by all people, including the physically handicapped.



**access**

The ability, freedom, or permission to approach, enter, or use.



**territoriality**

The pattern of behavior associated with defining and defending a territory or domain.

**personal space**

The variable and subjective distance at which one person feels comfortable talking to another. Also called **personal distance**.



# DESIGN

## design

To conceive, contrive, or devise the form and structure of a building or other construction.

## design process

A purposeful activity aimed at devising a plan for changing an existing situation into a future preferred state, esp. the cyclical, iterative process comprising the following phases.

## process

A systematic series of actions or operations leading or directed to a particular end.

## phase

A particular stage in a process of change or development.

## program

A procedure for solving a problem, as a statement setting forth the context, conditions, requirements, and objectives for a design project.

## dynamics

The pattern of change, growth, or development of an object or phenomenon.

## charrette

An intense effort to complete a design project within a specified time. Also, *tharette*.

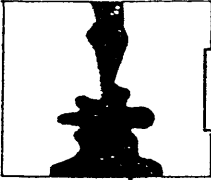


## reevaluation

Assessing how well an implemented solution in use satisfies the specified goals and criteria.

## implement

To ensure the fulfillment of by means of a definite plan or procedure.



## action

Selecting and implementing the most suitable solution.

## feedback

Evaluative information about an action or process prompting a return to a preceding phase for alteration or correction.

## evaluation

Simulating, testing, and modifying acceptable alternatives according to specified goals and criteria.

## communicate

To express, convey, or interchange ideas, information, or the like by writing, speaking, or through a common system of signs or symbols, esp. in a way that is clearly and readily understood.

## proposal

The offering of a plan for consideration, acceptance, or action.

## select

To choose from a number of alternatives by fitness or preference.

## judgment

The mental ability to perceive distinctions, comprehend relationships, or distinguish alternatives.

## function

The natural or proper action for which something is designed, used, or exists.

## purpose

The reason for which something exists or is done, made, or used.

## amenity

Any feature that provides or increases comfort, convenience, or pleasure.

## economy

Careful, thrifty, and efficient use and management of resources.



## conceive

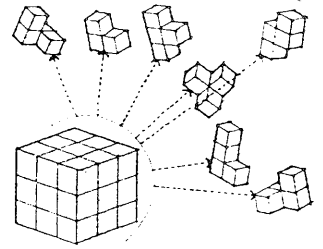
To form an idea or conception in the mind.

## contrive

To form in an artistic or ingenious manner.

## devise

To form in the mind by new combinations or applications of existing ideas or principles.



## analysis

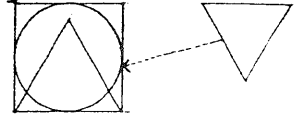
Separating of a whole into its constituent parts or elements, esp. as a method of studying the nature of the whole and determining its essential features and their relations.

## synthesis

Discovering constraints and opportunities, and hypothesizing possible alternative solutions.

## synthesis

Combining of separate, often diverse parts or elements so as to form a single or coherent whole.



## hypothesis

Formulating a tentative assumption in order to draw out and test its logical or empirical consequences.

## alternative

One of the propositions or courses of action to be chosen from a set of two or more mutually exclusive possibilities.

## develop

To work out, expand, or realize the capabilities or possibilities of so as to bring gradually to a fuller or more advanced or effective state.

## modify

To change the form, character, or qualities of in order to give a new orientation to or to serve a new end.

## refine

To improve or elaborate in order to make more fine or precise.

## inflection

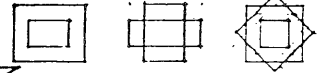
A bend, angle, or similar change in the shape of a configuration, by means of which a change of relationship to some context or condition is indicated.

## draft

A preliminary version of a plan or design.

## transformation

The process of changing in form or structure through a series of discrete permutations and manipulations in response to a specific context or set of conditions without a loss of identity or concept.



## evaluate

To ascertain or assess the significance, worth, or quality of, usually by careful appraisal and study.

## simulate

To create a likeness or model of something anticipated for testing and evaluation.

## criterion

A standard, rule, or principle on which a judgment or decision may be based.

## datum

An assumed, given, or otherwise determined fact or proposition from which conclusions may be drawn or decisions made.



## model

A miniature representation, usually built to scale, to show the appearance or construction of something.

## mock-up

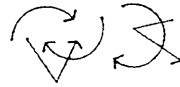
A full-sized model of a building or structure, built accurately to scale for study, testing, or teaching.

## test

To subject a system or process to such conditions or operations as will lead to a critical evaluation of abilities or performance and subsequent acceptance or rejection.

**reason**  
The faculty or power of comprehending, inferring, or thinking in an orderly, rational way.

**fancy**  
The play of the mind through which visions are summoned, esp. mental inventions that are whimsical, playful, and characteristically removed from reality.



**creativity**  
The ability to transcend traditional ideas, patterns, or relationships and to initiate meaningful new ideas, forms, or interpretations.

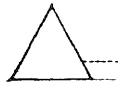
**visualize**  
To form or recall a mental image of.

**envision**  
To form a mental picture of a future possibility.

**image**  
A mental representation of something previously perceived in the absence of the original stimulus.

**reproductive imagination**  
The power of reproducing images stored in the memory under the suggestion of associated images.

**creative imagination**  
The power of recombining former experiences in the creation of new images directed at a specific goal or aiding in the solution of a problem.



**project**  
To regard an idea or concept as having some form of objective reality outside of the mind.

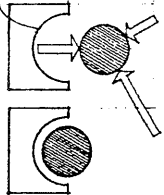
**vision**  
The act or power of anticipating that which will or may come to be.

**perspective**  
The faculty of seeing things in their true relations or of evaluating their relative significance.

**inform**  
To animate or permeate with a particular form, substance, quality, or distinction.

**address**  
To direct the efforts or attention of.

**engage**  
To attract and hold fast by influence or power.



**view**  
A particular manner or mode of looking at or regarding something.

**aspect**  
A way in which a thing may be viewed or regarded.



**originality**  
The creative ability to imagine or express in an independent and individual manner.

**imagination**  
The faculty of forming mental images or concepts of what is not present to the senses or perceived in reality.

**idea**  
A thought or notion resulting from mental awareness, understanding, or activity.

**concept**  
A mental image or formulation of what something is or ought to be, esp. an idea generalized from particular characteristics or instances.

**design concept**  
A concept for the form, structure, and features of a building or other construction, represented graphically by diagrams, plans, or other drawings.

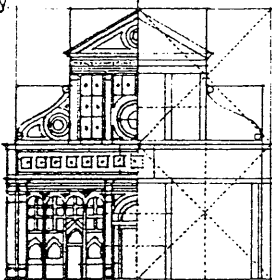
**scheme**  
An underlying organizational pattern or structure for a design.

**project**  
The original scheme for a design presented in the form of a sketch outlining its specific character, to be developed in detail in later studies.

**practice**  
Actual performance or application of principles, as distinguished from theory.

**theory**  
Abstract thought or speculation resulting in a system of assumptions or principles used in analyzing, explaining, or predicting phenomena, and proposed or followed as the basis of action.

**real**  
Having objective, verifiable, and independent existence, as opposed to being artificial or illusory.



**abstract**  
Thought of without reference to concrete reality or a particular instance.

**principle**  
A fundamental and comprehensive law, truth, or assumption governing action, procedure, or arrangement.

**metaphor**  
An object, activity, or idea used in place of another to suggest a likeness between them.

**analogy**  
A similarity in some particulars between things otherwise dissimilar; specif., a logical inference based on the assumption that if two things are known to be alike in some respects, then they will probably be alike in other respects.

**synectics**  
The study of creative processes, esp. as applied to the stating and solution of problems that involves free use of metaphor and analogy in informal interchange within a small group of diverse individuals.



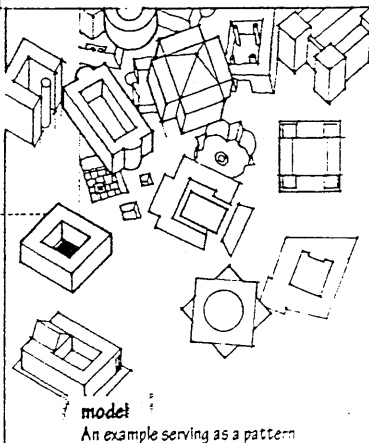
**typology**  
A systematic classification or study of types according to structural features.

**type**  
A number of things regarded as forming a group by reason of common attributes or characteristics.

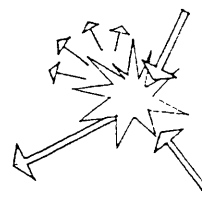
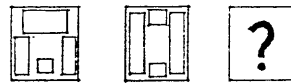
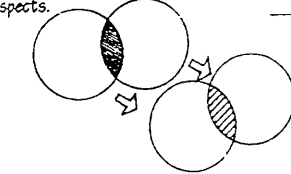
**archetype**  
An original model or pattern on which all things of the same kind are copied or based.

**ectype**  
A reproduction of an original.

**prototype**  
An early and typical example that exhibits the essential features of a class or group and on which later stages are based or judged.



**model**  
An example serving as a pattern for imitation or emulation in the creation of something.



**intuition**  
The power or faculty of knowing without evident rational thought and inference.

**speculation**  
Meditation or reflection on a subject or idea, resulting in a conclusion inferred from incomplete or inconclusive evidence.

**ambiguity**  
The state or quality of being susceptible to uncertainty of meaning or multiple interpretation.

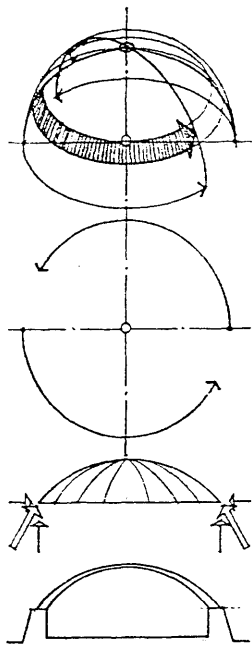
**serendipity**  
An aptitude for making desirable and unexpected discoveries by accident.

**accident**  
A fortuitous circumstance, quality, or characteristic.

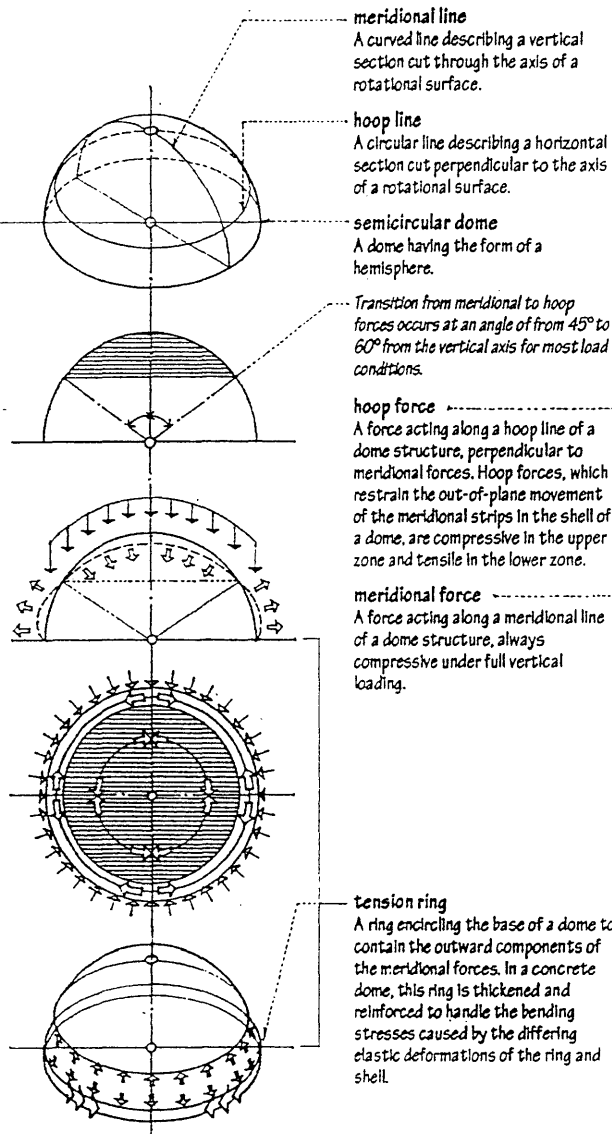
**connection**  
Contextual, causal, or logical relations or associations of something observed or imagined.

# DOME

A vaulted structure having a circular plan and usually the form of a portion of a sphere, so constructed as to exert an equal thrust in all directions.



**saucer dome**  
A dome having the form of a segment of a sphere, with its center well below the springing line. A saucer dome is particularly sensitive to buckling under an external load.



**meridional line**  
A curved line describing a vertical section cut through the axis of a rotational surface.

**hoop line**  
A circular line describing a horizontal section cut perpendicular to the axis of a rotational surface.

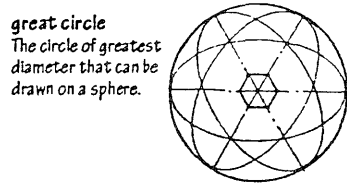
**semicircular dome**  
A dome having the form of a hemisphere.

Transition from meridional to hoop forces occurs at an angle of from 45° to 60° from the vertical axis for most load conditions.

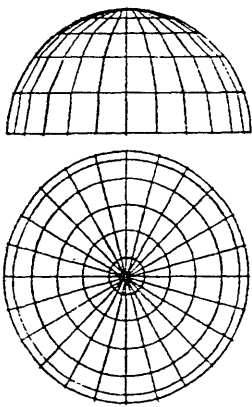
**hoop force**  
A force acting along a hoop line of a dome structure, perpendicular to meridional forces. Hoop forces, which restrain the out-of-plane movement of the meridional strips in the shell of a dome, are compressive in the upper zone and tensile in the lower zone.

**meridional force**  
A force acting along a meridional line of a dome structure, always compressive under full vertical loading.

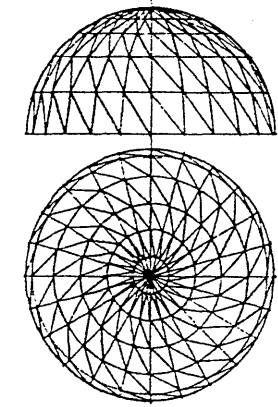
**tension ring**  
A ring encircling the base of a dome to contain the outward components of the meridional forces. In a concrete dome, this ring is thickened and reinforced to handle the bending stresses caused by the differing elastic deformations of the ring and shell.



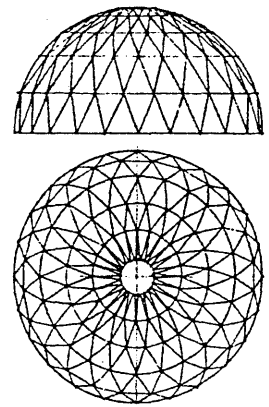
**great circle**  
The circle of greatest diameter that can be drawn on a sphere.



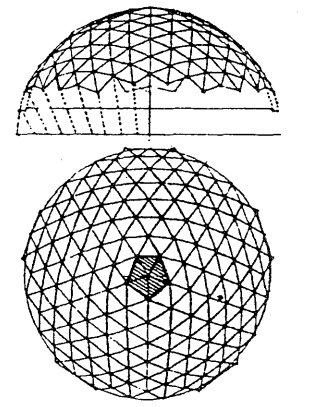
**radial dome**  
A dome built with steel or timber trusses arranged in a radial manner and connected by polygonal rings at various heights.



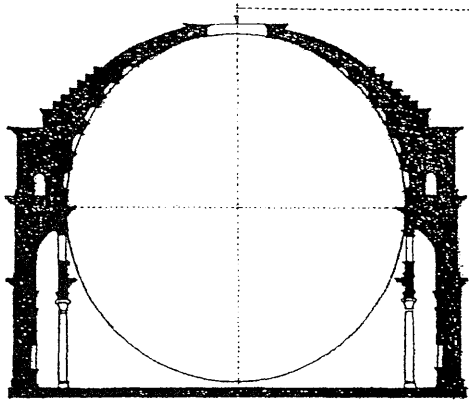
**Schwedler dome**  
A steel dome having members which follow the lines of latitude and longitude, and a third set of diagonals completing the triangulation.



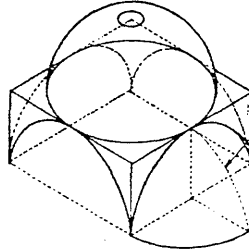
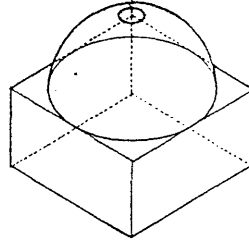
**lattice dome**  
A steel dome structure having members which follow the circles of latitude, and two sets of diagonals replacing the lines of longitude and forming a series of isosceles triangles.



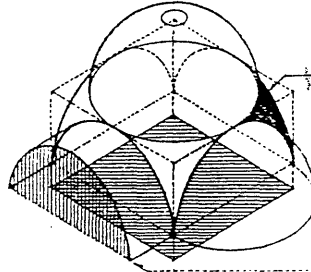
**geodesic dome**  
A steel dome having members which follow three principal sets of great circles intersecting at 60°, subdividing the dome surface into a series of equilateral spherical triangles.



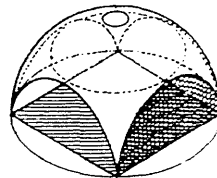
**oculus**  
A circular opening, esp. one at the crown of a dome.



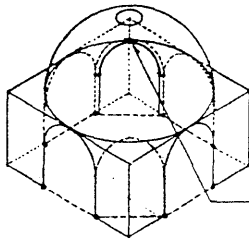
**semidome**  
Half a dome formed by a vertical section, as over a semicircular apse.  
**cul-de-four**  
A semidome or quarter-sphere vault, as over an apse or niche.



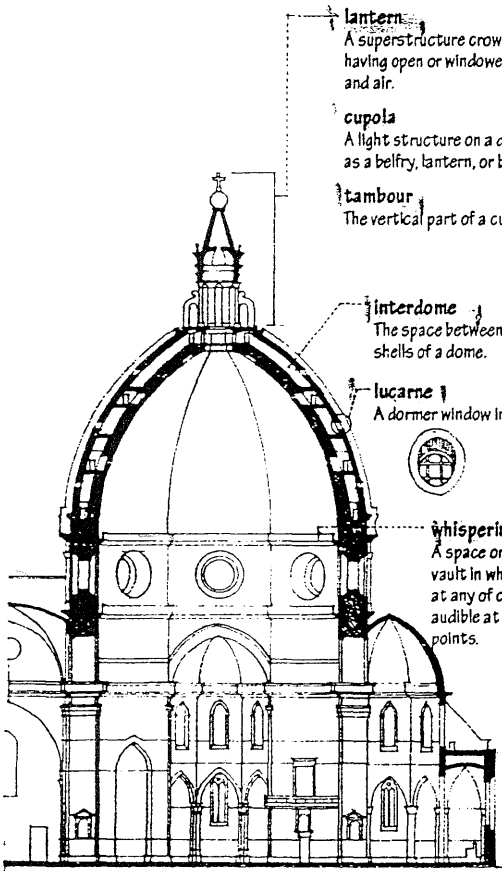
**pendentive**  
A spherical triangle forming the transition from the circular plan of a dome to the polygonal plan of its supporting structure.



**lunette**  
An area in the plane of a wall framed by an arch or vault, containing a window, painting, or sculpture.



**pendentive dome**  
A spherical dome formed by removing four segments so that it merges with its pendentives and sits on a square plan.



**lantern**  
A superstructure crowning a roof or dome having open or windowed walls to let in light and air.

**cupola**  
A light structure on a dome or roof, serving as a belfry, lantern, or belvedere.

**tambour**  
The vertical part of a cupola.

**interdome**  
The space between the inner and outer shells of a dome.

**lucarne**  
A dormer window in a roof or spire.



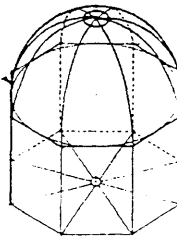
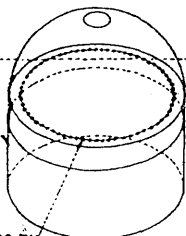
**whispering gallery**  
A space or gallery beneath a dome or vault in which low sounds produced at any of certain points are clearly audible at certain other distant points.

**squinch**  
An arch or corbeling built across the upper inside corner of a square tower to support the side of a superimposed octagonal structure.

**drum**  
A cylindrical or faceted construction, often pierced with windows, supporting a dome.

**tholobate**  
The substructure supporting a dome or cupola.

**bandage**  
A strap, ring, or chain placed around a structure to secure and hold its parts together, as around the springing of a dome.

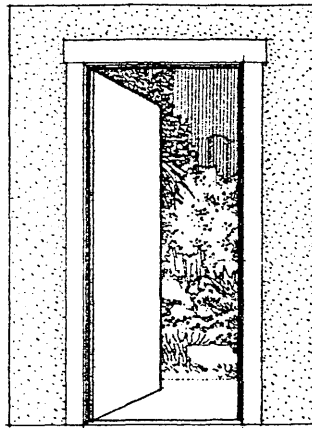
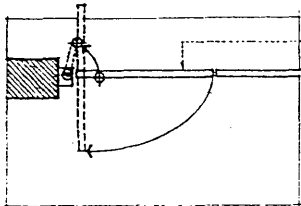
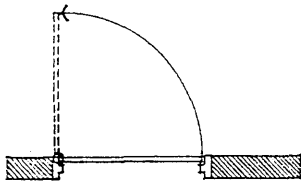


# DOOR

A hinged, sliding, or folding barrier of wood, metal, or glass for opening and closing an entrance to a building, room, or cabinet.

## swinging door

A door that turns on hinges or pivots about a vertical edge when pushed or pulled.

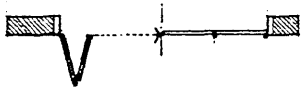


**balanced door**  
A pivoted door that is partially counterbalanced for easier opening and closing.

**automatic door**  
A door that opens automatically at the approach of a person or automobile.

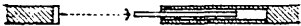
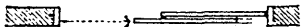
## pivoted door

A door carried on and swinging about on a center or offset pivot, as distinguished from one hung on hinges.



## folding door

A door with hinged sections that can be folded flat against one another when opened.

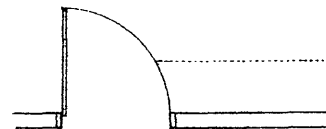
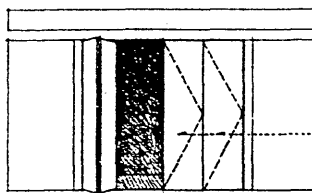
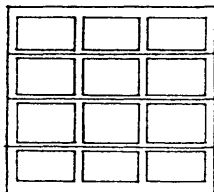


## sliding door

A door that operates or moves by sliding on a track, usually parallel to a wall.

## rolling door

A large door consisting of horizontal, interlocking metal slats guided by a track on either side, opening by rolling about an overhead drum at the head of the door opening.



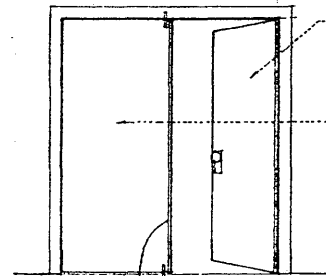
**single-acting door**  
A door hung on hinges that permit it to swing in one direction only.



**double-acting door**  
A door hung on hinges that permit it to swing in either direction from a closed position.



**double doors**  
A pair of doors hung in the same doorframe.

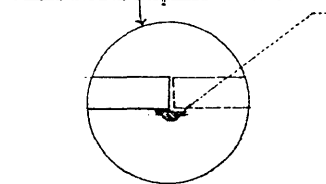
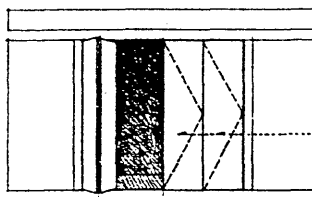


**leaf**  
A hinged or sliding section of a door or shutter.

**active leaf**  
The leaf of a pair of double doors to which the latching or locking mechanism is attached. Also called opening leaf.

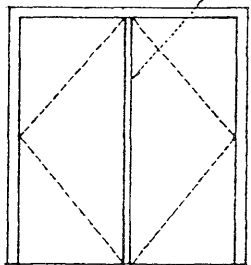
**inactive leaf**  
The leaf of a pair of double doors to which the strike plate is fastened to receive the latch or bolt of the active leaf, usually fixed in a closed position by bolts at the top and bottom of the door. Also called standing leaf.

**door opener**  
A mechanism that automatically opens a door when actuated by a radio transmitter, electric eye, or other device.

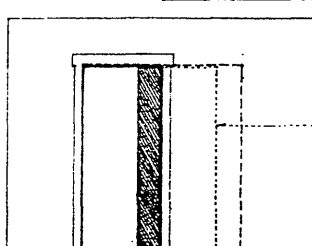


**astragal**  
A molding attached to one or both meeting stiles of a pair of double doors to prevent drafts or the passage of light, noise, or smoke.

**mullion**  
A slender vertical member dividing the opening for a pair of double doors, sometimes removable to permit the passage of large objects.

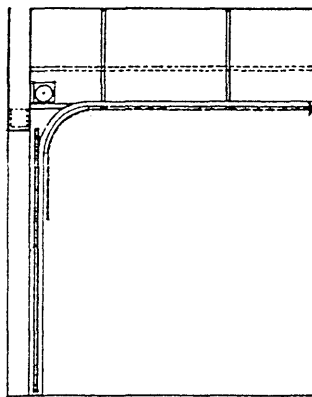


**bifold door**  
A folding door that divides into two parts, the inner leaf of each part being hung from an overhead track and the outer leaf pivoted at the jamb.

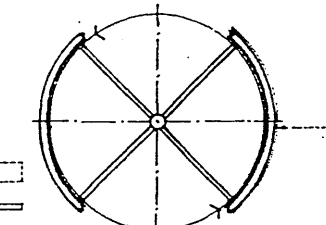


**accordion door**  
A multileafed door that is hung from an overhead track and opens by folding back in the manner of an accordion.

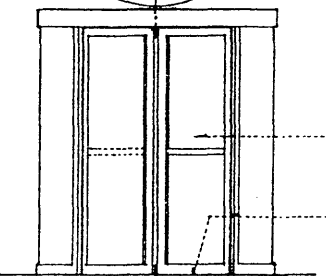
**pocket door**  
A door that slides into and out of a recess in a doorway wall.



**overhead door**  
A large door constructed of one or several leaves, opening by swinging or rolling up to a horizontal position above the door opening.



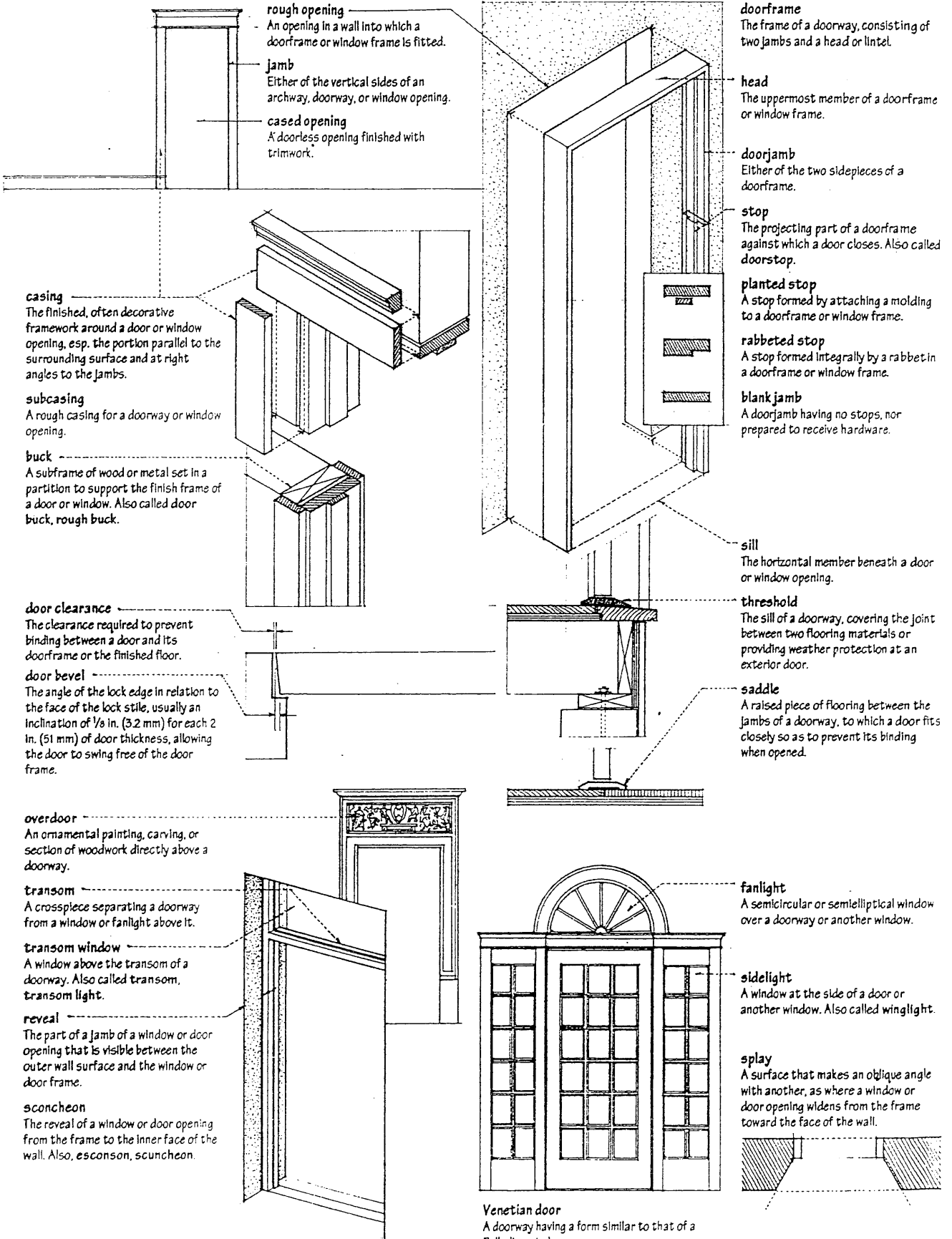
**revolving door**  
An entrance door for excluding drafts from the interior of a building, consisting of four leaves set in the form of a cross and rotating about a central, vertical pivot within a cylindrical shaped vestibule. Some revolving doors automatically fold back in the direction of egress when pressure is applied, providing a legal passageway on both sides of the door pivot.



**wing**  
One of the leaves of a double or revolving door.

**sweep**  
The flexible weatherstripping along the edges of a revolving door.

**air curtain**  
A stream of compressed air directed downward across a doorway so as to form a shield to exclude drafts.



**rough opening**  
An opening in a wall into which a doorframe or window frame is fitted.

**jamb**  
Either of the vertical sides of an archway, doorway, or window opening.

**cased opening**  
A doorless opening finished with trimwork.

**doorframe**  
The frame of a doorway, consisting of two jambs and a head or lintel.

**head**  
The uppermost member of a doorframe or window frame.

**doorjamb**  
Either of the two sidepieces of a doorframe.

**stop**  
The projecting part of a doorframe against which a door closes. Also called doorstop.

**planted stop**  
A stop formed by attaching a molding to a doorframe or window frame.

**rabbeted stop**  
A stop formed integrally by a rabbet in a doorframe or window frame.

**blank jamb**  
A doorjamb having no stops, nor prepared to receive hardware.

**casing**  
The finished, often decorative framework around a door or window opening, esp. the portion parallel to the surrounding surface and at right angles to the jambs.

**subcasing**  
A rough casing for a doorway or window opening.

**buck**  
A subframe of wood or metal set in a partition to support the finish frame of a door or window. Also called door buck, rough buck.

**door clearance**  
The clearance required to prevent binding between a door and its doorframe or the finished floor.

**door bevel**  
The angle of the lock edge in relation to the face of the lock stile, usually an inclination of 1/8 in. (3.2 mm) for each 2 in. (51 mm) of door thickness, allowing the door to swing free of the door frame.

**overdoor**  
An ornamental painting, carving, or section of woodwork directly above a doorway.

**transom**  
A crosspiece separating a doorway from a window or fanlight above it.

**transom window**  
A window above the transom of a doorway. Also called transom, transom light.

**reveal**  
The part of a jamb of a window or door opening that is visible between the outer wall surface and the window or door frame.

**sconcheon**  
The reveal of a window or door opening from the frame to the inner face of the wall. Also, esconson, scuncheon.

**sill**  
The horizontal member beneath a door or window opening.

**threshold**  
The sill of a doorway, covering the joint between two flooring materials or providing weather protection at an exterior door.

**saddle**  
A raised piece of flooring between the jambs of a doorway, to which a door fits closely so as to prevent its binding when opened.

**fanlight**  
A semicircular or semielliptical window over a doorway or another window.

**sidelight**  
A window at the side of a door or another window. Also called winglight.

**splay**  
A surface that makes an oblique angle with another, as where a window or door opening widens from the frame toward the face of the wall.

**Venetian door**  
A doorway having a form similar to that of a Palladian window.

# DOOR

## paneled door

A door having a framework of stiles, rails, and sometimes muntins, filled with panels of a thinner material.

### rail

Any of various horizontal members framing panels, as in a system of paneling, a paneled door, window sash, or chest of drawers.

### top rail

The uppermost rail connecting the stiles of a paneled door or window sash.

### lock rail

The rail of a door that meets the shutting stile at the level of the lockset.

### bottom rail

The lowest rail connecting the stiles of a paneled door or window sash.

### panel

A distinct section or division of a wall, ceiling, or door, recessed below or raised above the general level or enclosed by a frame.

### stile

Any of various upright members framing panels, as in a system of paneling, a paneled door, window sash, or a chest of drawers.

### hinge stile

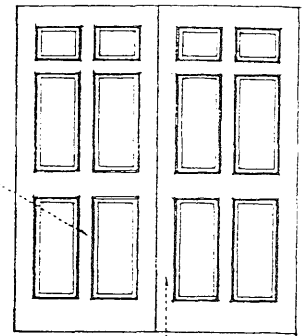
The stile of a door by which it is hung. Also called hanging stile.

### lock stile

The stile of a door that closes against the frame of the opening. Also called shutting stile.

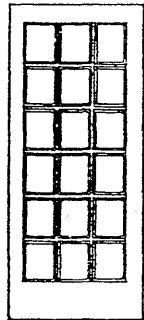
### muntin

A stile within the frame of a door.



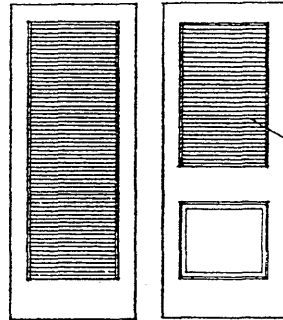
### meeting stile

One of the abutting stiles in a pair of double doors.



## French door

A door having rectangular glass panes extending throughout its length, and often hung in pairs. Also called casement door.



## louvered door

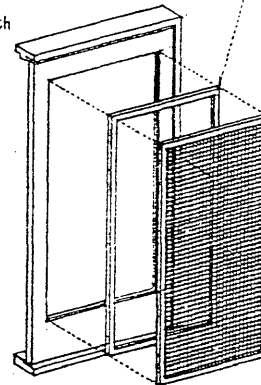
A door having a louvered opening for the passage or circulation of air. Also called blind door.

### vision light

A small light in the upper portion of a door glazed with clear glass for viewing.

## louver

An opening fitted with slanting, fixed or movable slats to admit air but exclude rain and snow or to provide privacy. Also, louvre.



### storm door

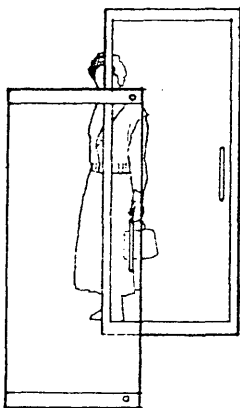
An outer or supplementary door, usually glazed, for protecting an entrance door from drafts, driving rain, or severe weather.

### screen door

An exterior door having wood or aluminum stiles and rails that hold a wire or plastic mesh to admit air but exclude insects.

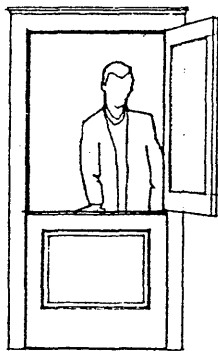
## combination door

An exterior door having a frame into which different types of panels can be inserted, as a screen for summer or storm sash for winter.



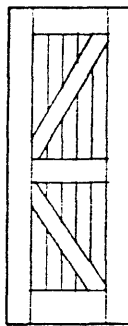
## glass door

A door of heat-strengthened or tempered glass, with or without rails or stiles, used primarily as an entrance door.



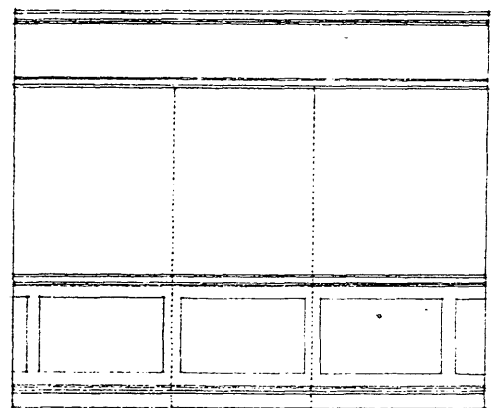
## Dutch door

A door divided horizontally so that the upper or lower part can be opened or closed separately.



## batten door

A door constructed of vertical boards held together by horizontal battens and diagonal bracing.



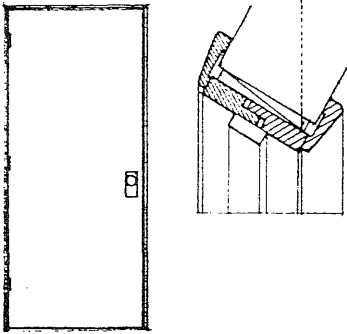
## jib door

A door hinged to be flush with the wall on either side and treated so as to be indiscernible when closed. Also, gib door.



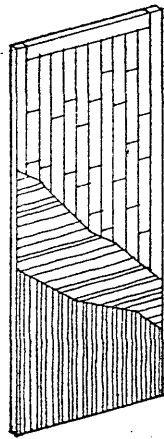
**adjustable doorframe**

A doorframe having a split head and jambs for installation in various wall thicknesses.



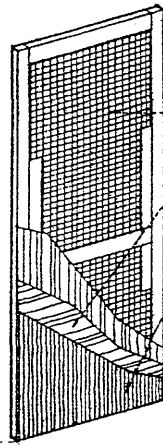
**prehung door**

A door hung in a doorframe before installation in a wall, sometimes prefinished and prefitted with all necessary hardware and casing trim.



**solid-core door**

A wood flush door having a solid core of staved lumber, particle board, or a mineral composition.

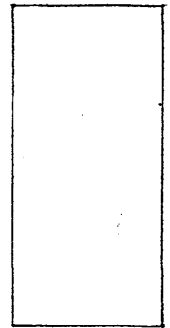


**hollow-core door**

A wood flush door having a framework of stiles and rails encasing an expanded honeycomb core of corrugated fiberboard or a grid of interlocking horizontal and vertical wood strips.

**flush door**

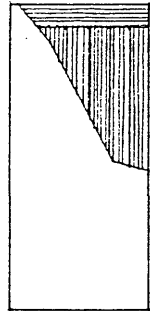
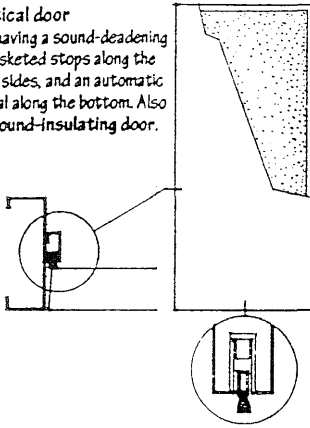
A door having smooth-surfaced faces.



- core**  
A wooden construction, as in a door, forming a backing for face veneers.
- crossbanding**  
The plywood or hardboard veneer immediately beneath the face veneers of a flush door. Also, crossband.
- doorskin**  
A surface veneer of plywood, hardboard, plastic laminate, or medium density overlay, bonded to the crossbanding or core of a flush door.

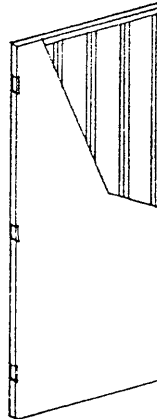
**acoustical door**

A door having a sound-deadening core, gasketed stops along the top and sides, and an automatic drop seal along the bottom. Also called sound-insulating door.



**kalamein door**

A door having a structural wood core clad with galvanized sheet metal.

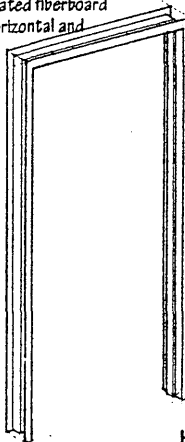


**hollow metal door**

A door having face sheets of light-gauge steel bonded to a steel channel frame, reinforced with channels, a kraft honeycomb structure, or a rigid plastic-foam core.

**throat**

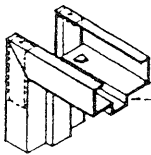
The opening between the backbends of a metal doorframe.



- backbend**  
The face at the outer edge of a metal doorframe that returns to the wall surface.

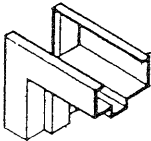
**hollow metal frame**

A doorframe having a head and jambs formed from a single piece of metal.



**knockdown frame**

A metal doorframe composed of three or more parts for assembly in the field.

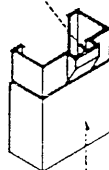


**welded frame**

A metal doorframe that is completely set up and welded at the factory.

**cutoff stop**

A stop having a closed end that terminates above the floor line a 45° or 90° angle. Also called hospital stop, sanitary stop.

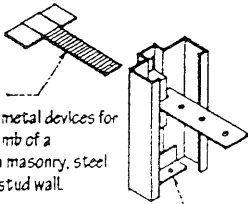


**spat**

A protective lining, usually of stainless steel, at the base of a doorframe.

**jamb anchor**

Any of various metal devices for securing the jamb of a doorframe to a masonry, steel stud, or wood stud wall.



**anchor**

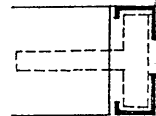
Any of various metal devices for binding one part of a structure to another.

**base anchor**

A metal clip or device for securing the base of a doorframe to the floor.

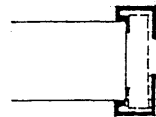
**flush frame**

A metal doorframe designed to be installed during the construction of a masonry or stud wall.



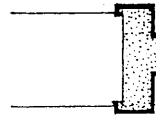
**drywall frame**

A knockdown frame having a double-return backbend for installation after a drywall partition is finished.



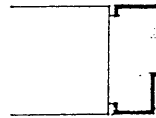
**grouted frame**

A metal doorframe completely filled with plaster or mortar for structural rigidity and increased fire resistance.



**double egress frame**

A metal doorframe prepared to receive a pair of single-acting doors that swing in opposite directions.



# DRAWING

The art, process, or technique of representing an object, scene, or idea by means of lines on a surface.

## technique

A method or procedure for accomplishing a desired aim or task, as that employed by an artist showing a high degree of skill or command of fundamentals.

## contour drawing

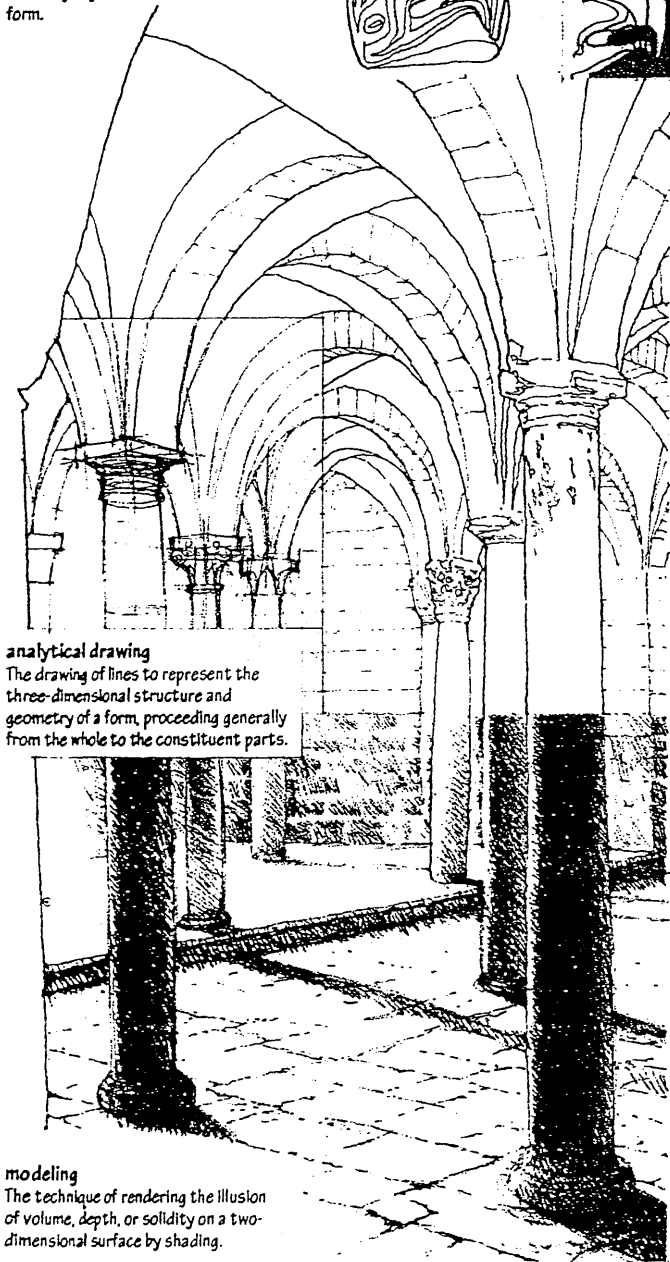
The technique of drawing lines to represent the contours of a subject, without shading or modeling of form.

## contour

The outline of a two-dimensional shape or bounding edges of a three-dimensional form.

## freehand drawing

The art, process, or technique of drawing by hand without the aid of drafting instruments or mechanical devices, esp. for the representation of perceptions or the visualization of ideas.



## analytical drawing

The drawing of lines to represent the three-dimensional structure and geometry of a form, proceeding generally from the whole to the constituent parts.

## modeling

The technique of rendering the illusion of volume, depth, or solidity on a two-dimensional surface by shading.

## grisaille

Monochromatic painting in shades of gray to produce a three-dimensional effect.

## SEEING

## image

A representation of the form or appearance of something, made visible in a sculpture, photograph, or drawing.

## PERCEIVING IMAGINING

## DRAWING

## line

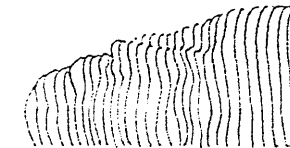
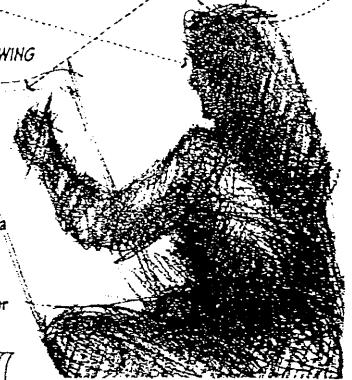
A thin, continuous mark made on a surface with a pencil, pen, or brush, as distinguished from shading or color.

## outline

A line describing the outer boundary of a figure or object.

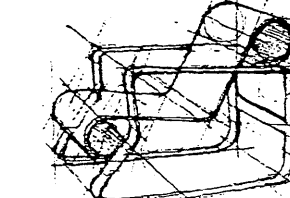
## profile

An outline of a form or structure seen or represented from the side.



## cross-contour drawing

The technique of drawing lines to represent a series of cuts across the surface of a form rather than its edges.



## regulating line

A line drawn to measure or express alignment, scale, or proportion.

## trace

A line lightly drawn to record alignment or measurement.

## gesture drawing

The technique of drawing a single or multiple lines freely and quickly as a subject is scanned and perceptions of volume, mass, movement, and significant details are projected onto the drawing surface. In contrast to contour drawing, gesture drawing generally proceeds from the whole to the parts.

## gesture

A movement of the hand, arm, head, face, or body that expresses an idea, opinion, or emotion.

## movement

The effect or illusion of motion conveyed by the relationship of structural elements in a design or composition.

## shading

The rendering of light and dark values in a drawing to create the illusion of three-dimensionality, represent light and shadow, or give the effect of color.

## hatching

Shading composed of fine lines drawn in close proximity.

## crosshatching

Shading composed of two or more series of intersecting parallel lines.

## scribbling

Shading by means of a network of random, multidirectional lines.

## stippling

Shading by means of dots, small spots, or short strokes.

## key

The dominant tonal value of a drawing or painting.



## high-key

Having chiefly light tones with little contrast.

## low-key

Having chiefly dark tones with little contrast.

**sketch**  
A simply or hastily executed drawing or painting representing the essential features of an object or scene without the details, often made as a preliminary study.

**study**  
A drawing executed as an educational exercise, produced as a preliminary to a final work, or made to record observations. Sometimes referred to as a referential drawing.

**conception**  
A drawing of something that does not yet exist.

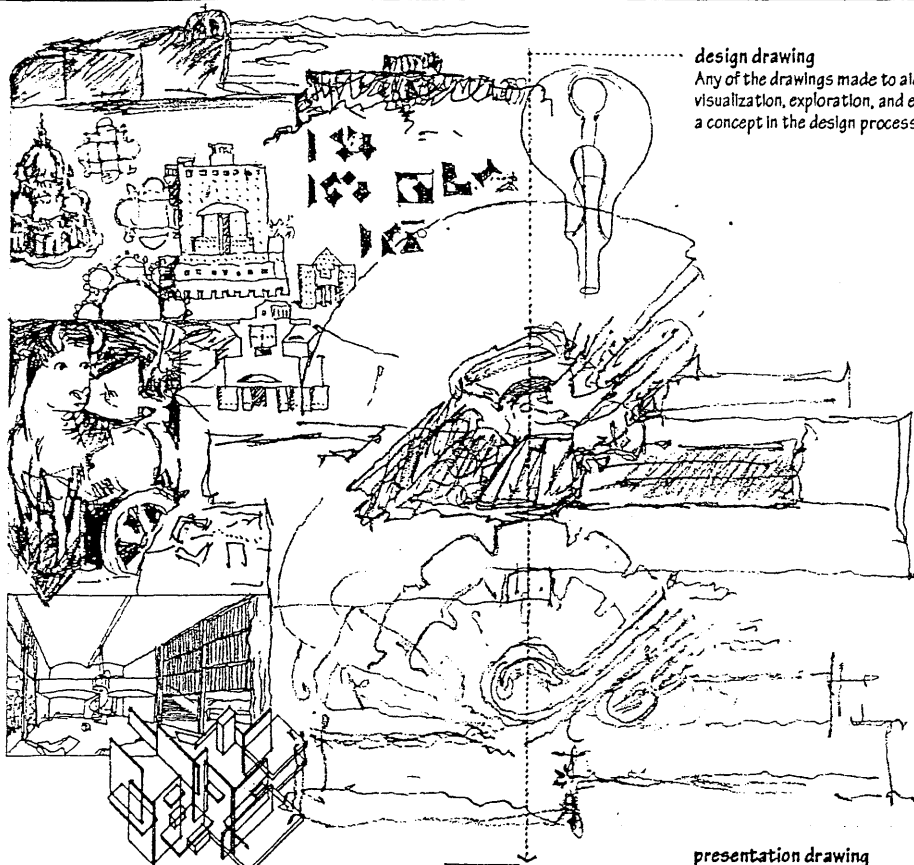
**draft**  
A preliminary sketch of a design or plan, esp. one subject to revision.

**esquisse**  
A sketch showing the general features of a design or plan.

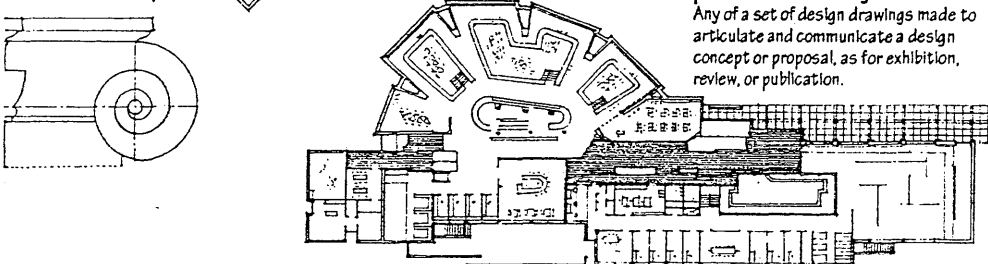
**épure**  
A full-scale, detailed drawing done on a wall, floor, or other large surface, from which are traced the patterns for various building elements.

**cartoon**  
A full-scale drawing of a motif or design, to be transferred in preparation for a fresco, mosaic, or tapestry.

**rendering**  
A drawing, esp. a perspective, of a building or interior space, artistically delineating materials, shades and shadows; usually done for the purposes of presentation and persuasion.



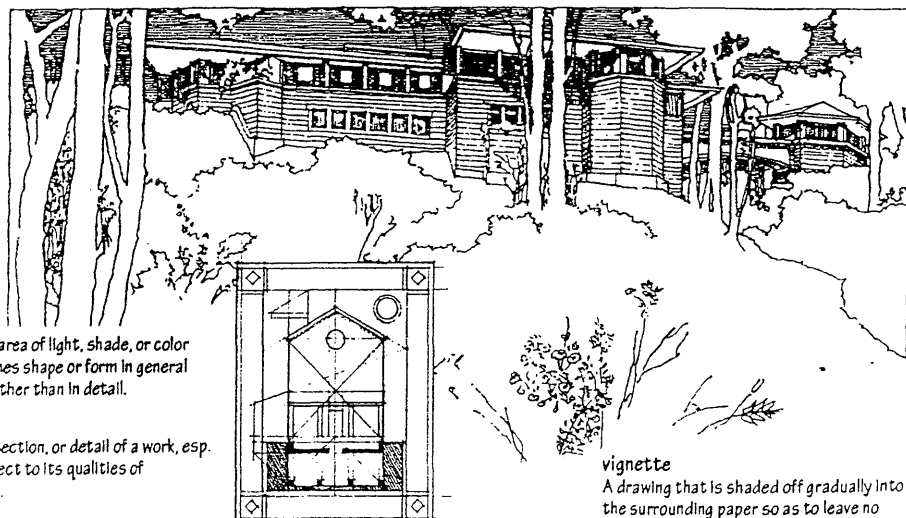
**design drawing**  
Any of the drawings made to aid in the visualization, exploration, and evaluation of a concept in the design process.



**presentation drawing**  
Any of a set of design drawings made to articulate and communicate a design concept or proposal, as for exhibition, review, or publication.

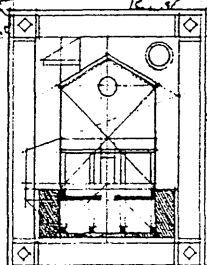


**trompe l'oeil**  
A drawing or painting in which objects are rendered in extremely fine detail to emphasize the illusion of tactile and spatial qualities.



**mass**  
A unified area of light, shade, or color that defines shape or form in general outline rather than in detail.

**passage**  
An area, section, or detail of a work, esp. with respect to its qualities of execution.



**analytique**  
An elevation drawing of a facade, surrounded by a decorative arrangement of drawings of important details and sometimes a plan or section of the facade.

**vignette**  
A drawing that is shaded off gradually into the surrounding paper so as to leave no definite line at the border.

# DRAWING

## drafting

Drawing done with the aid of such instruments as T-squares, triangles, compasses, and scales, esp. for the systematic representation and dimensional specification of architectural and engineering structures. Also called mechanical drawing.

### object line

A solid line representing a contour of an object.

### dashed line

A broken line consisting of short, closely spaced strokes, used esp. to represent object lines that are hidden or removed from view.

### dotted line

A broken line consisting of a series of closely spaced dots, sometimes used in place of a dashed line.

### centerline

A broken line consisting of relatively long segments separated by single dashes or dots, used to represent the axis of a symmetrical element or composition.

### grid

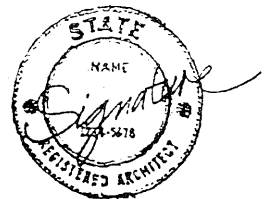
A rectangular system of lines and coordinates serving as a reference for locating and regulating the elements of a plan.

### construction drawings

The portion of the contract documents showing in accurate graphic or pictorial form the design, location, dimensions, and relationships of the elements of a project. Also called contract drawings, working drawings.

### seal

An embossing stamp used by a licensed architect, engineer, or other design professional on contract drawings and specifications to show evidence of registration in the state where the work is to be performed.

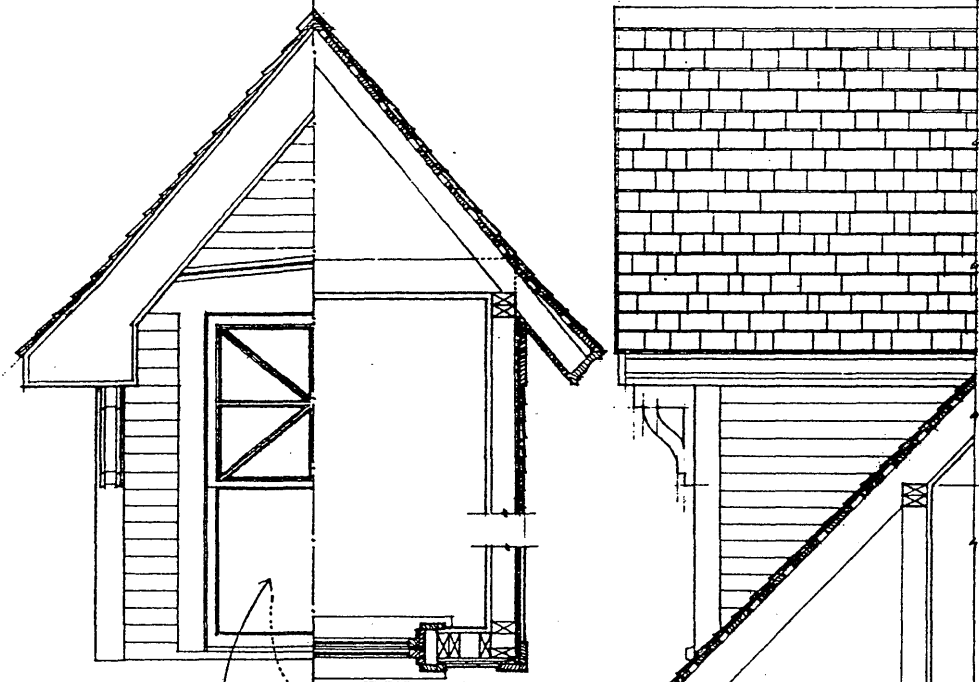
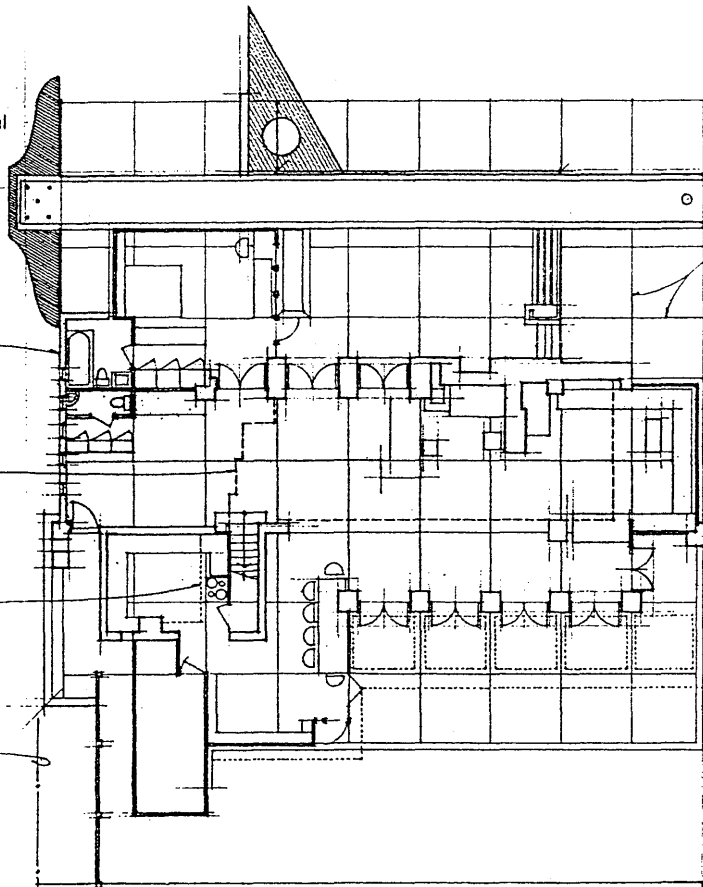


### extension line

A line extending from an edge or feature of an object, to which a dimension line is drawn.

### dimension line

A line terminated by arrows, short slashes, or dots, indicating the extent or magnitude of a part or the whole, and along which measurements are scaled and indicated.



### crowfoot

A V-shaped mark the apex of which is a reference point.

### leader

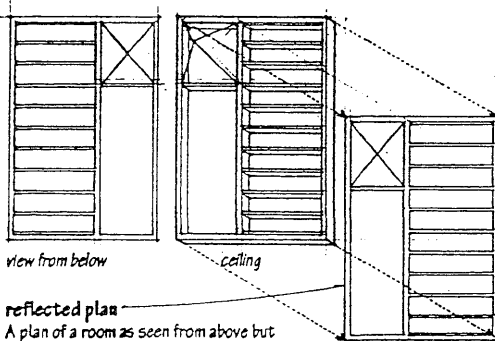
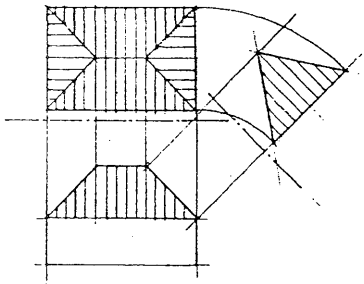
A short line leading the eye from a note or dimension to a reference point, line, or area.

### break line

A broken line consisting of relatively long segments joined by short zigzag strokes, used to cut off a portion of a drawing.

**descriptive geometry**

The theory of making projections of three-dimensional objects on a plane surface in order to deduce their geometric properties and relationships.



view from below

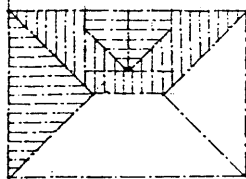
ceiling

**reflected plan**

A plan of a room as seen from above but having its ceiling surfaces and elements projected downward upon it so that what would appear to the right when seen from below appears on the plan to the left. Also called reflected ceiling plan.

**framing plan**

A plan showing the pattern, elements, and connections of the structural frame for a floor or roof of a building, using a system of symbols and drafting linework.

**contour line**

An imaginary line joining points of equal elevation on a surface, or its representation on a topographic plan or map.

**contour interval**

The difference in elevation represented by each contour line on a topographic plan or map.

**grading plan**

A plan showing the proposed finish contours and elevations of the ground surface of a construction site.

**north arrow**

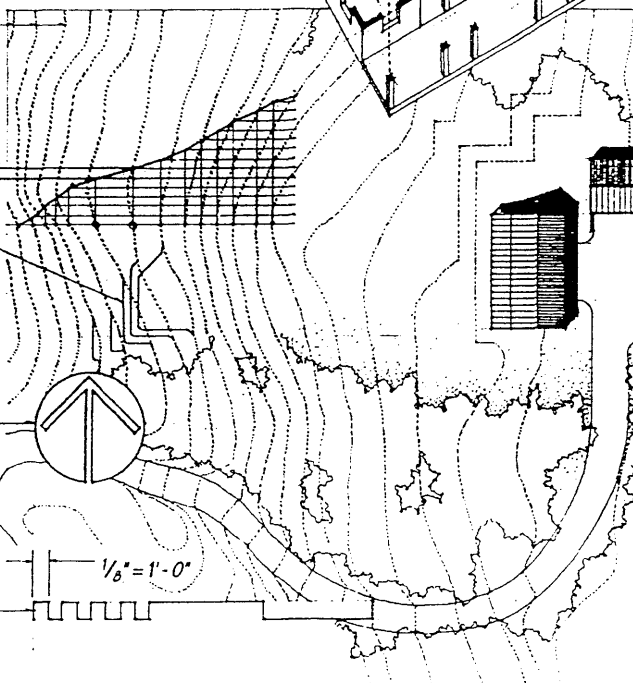
A graphic symbol used on plans and maps to indicate the direction of north.

**scale**

A proportion determining the relationship of a representation to that which it represents.

**graphic scale**

A graduated line or bar indicating the proportion between a representation and that which it represents.

**projection**

The process or technique of representing a three-dimensional object by projecting all its points by straight lines, either parallel or converging, to a picture plane.

**orthographic projection**

A method of projection in which a three-dimensional object is represented by projecting lines perpendicular to a picture plane. Also called orthogonal projection.

**plan**

An orthographic projection of the top or section of an object or structure on a horizontal plane, usually drawn to scale. Also called plan view.

**floor plan**

A plan of a room, suite, or entire floor of a building as seen from above after a horizontal section is cut and the upper portion removed, typically showing the form and arrangement of interior spaces and their enclosing walls, windows, and doors.

**poché**

The walls, columns, and other solids of a building that are cut in a floor plan or section drawing. Indicated usually in black or by hatching.

**roof plan**

A plan showing the top view of a building, esp. the form of its roof.

**site plan**

A plan showing the form, location, and orientation of a building or group of buildings on a site, usually including the dimensions, contours, landscaping and other significant features of the plot. Also called plot plan.

**area plan**

A plan showing the principal elements of a design project in the wider context of its surrounding environment.

**section**

An orthographic projection of an object or structure as it would appear if cut through by an intersecting plane to show its internal configuration, usually drawn to scale.

**cross section**

An orthographic projection of a section made by cutting transversely, esp. at right angles to the long axis of an object. Also called transverse section.

**longitudinal section**

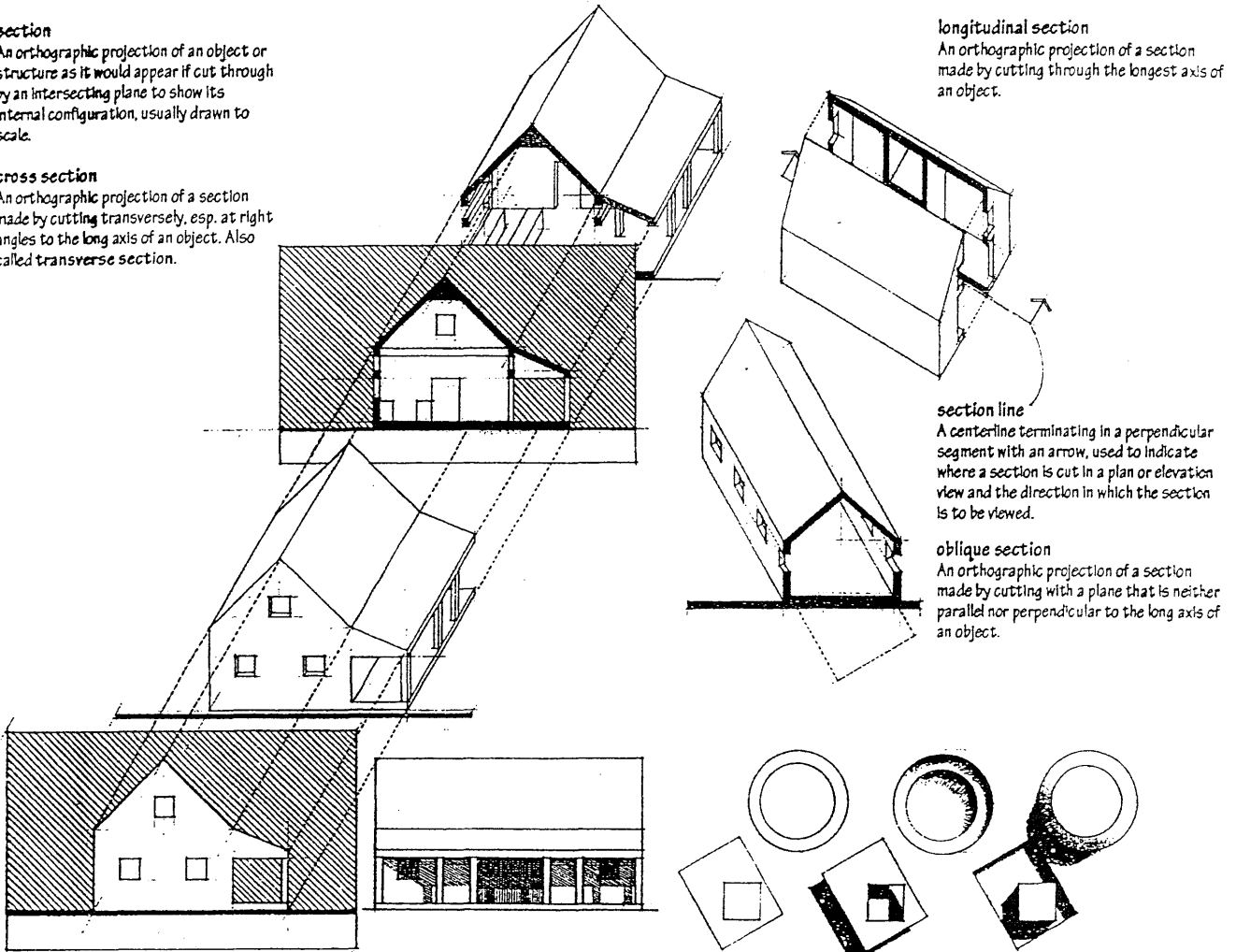
An orthographic projection of a section made by cutting through the longest axis of an object.

**section line**

A centerline terminating in a perpendicular segment with an arrow, used to indicate where a section is cut in a plan or elevation view and the direction in which the section is to be viewed.

**oblique section**

An orthographic projection of a section made by cutting with a plane that is neither parallel nor perpendicular to the long axis of an object.



**elevation**

An orthographic projection of an object or structure on a vertical picture plane parallel to one of its sides, usually drawn to scale.

**shades and shadows**

The casting and rendering of shades and shadows, esp. in orthographic views, to convey light, surface, form, and depth.

**relief**

An apparent projection from a flat background due to contrast, creating the illusion of three dimensions.

**shade**

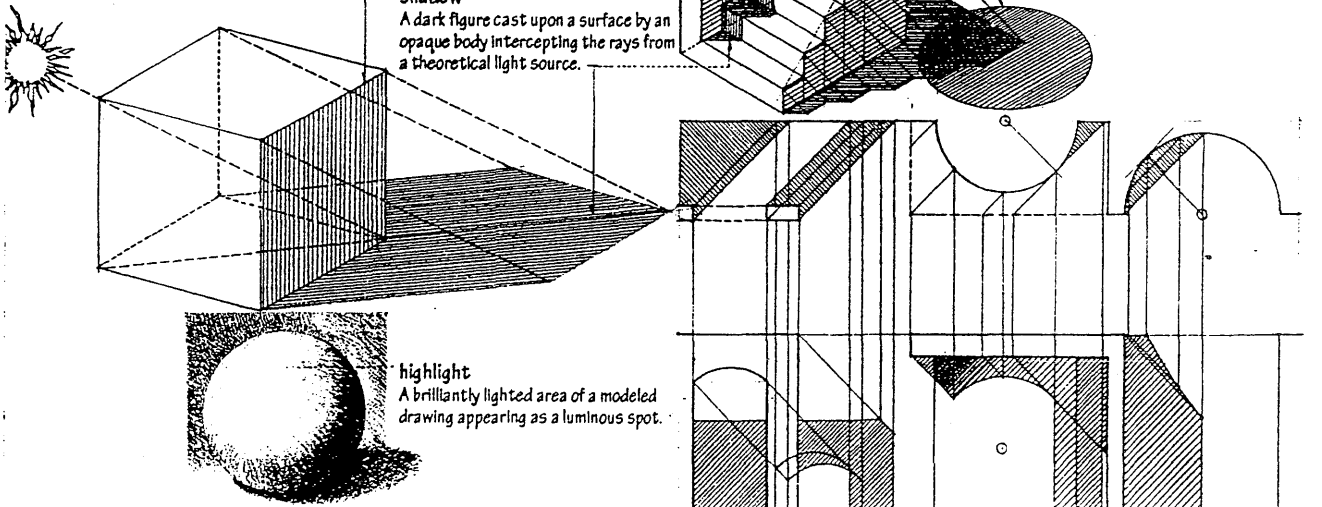
The parts of a solid that receive no light because they are tangent to or turned away from a theoretical light source.

**shadow**

A dark figure cast upon a surface by an opaque body intercepting the rays from a theoretical light source.

**local color**

The natural color of a particular object as it would appear in white light.

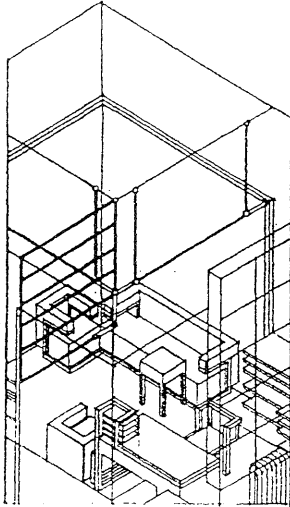


**highlight**

A brilliantly lighted area of a modeled drawing appearing as a luminous spot.

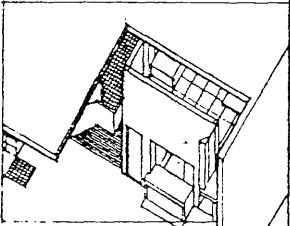
**parallel drawing**

Any of various single-view drawings characterized by parallel lines remaining parallel to each other rather than converging as in linear perspective.



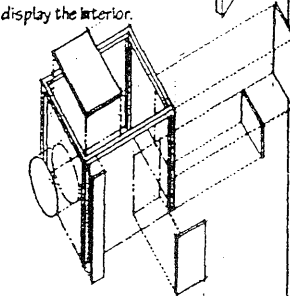
**phantom**

A part of a drawing that is made transparent to permit representation of details otherwise hidden from view.



**cutaway**

A drawing or model having an outer section removed to display the interior.

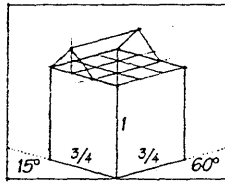
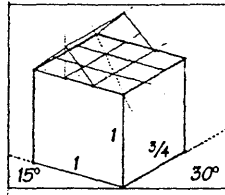
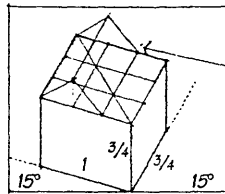


**exploded view**

A drawing that shows the individual parts of a structure or construction separately but indicates their proper relationships to each other and to the whole. Also called expanded view.

**phantom line**

A broken line consisting of relatively long segments separated by two short dashes or dots, used to represent a property line, an alternative position of a part of an object, or the relative position of an absent part.

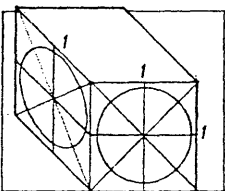
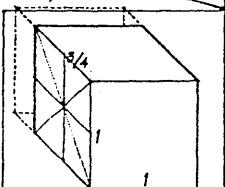
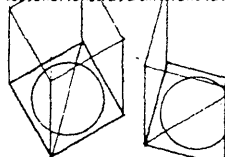


**dimetric projection**

An axonometric projection of a three-dimensional object inclined to the picture plane in such a way that two of its principal axes are equally foreshortened and the third appears longer or shorter than the other two.

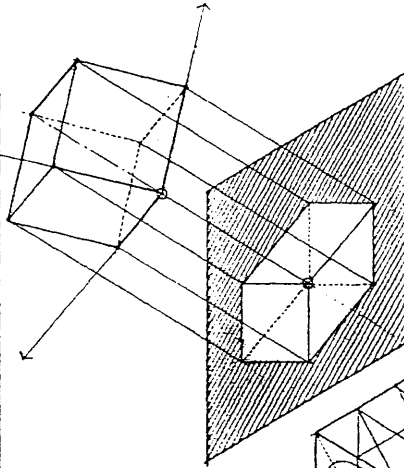
**trimetric projection**

An axonometric projection of a three-dimensional object inclined to the picture plane in such a way that all three principal axes are foreshortened at a different rate.



**cavalier drawing**

A parallel drawing of an oblique projection, having the receding lines perpendicular to the picture plane drawn to the same scale as the lines parallel to the picture plane.

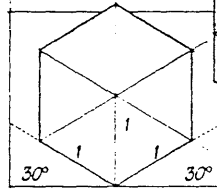


**axonometric projection**

The orthographic projection of a three-dimensional object inclined to the picture plane in such a way that its three principal axes are foreshortened.

**axonometric**

A parallel drawing of an axonometric projection, having all lines parallel to the three principal axes drawn to scale but diagonal and curved lines distorted.

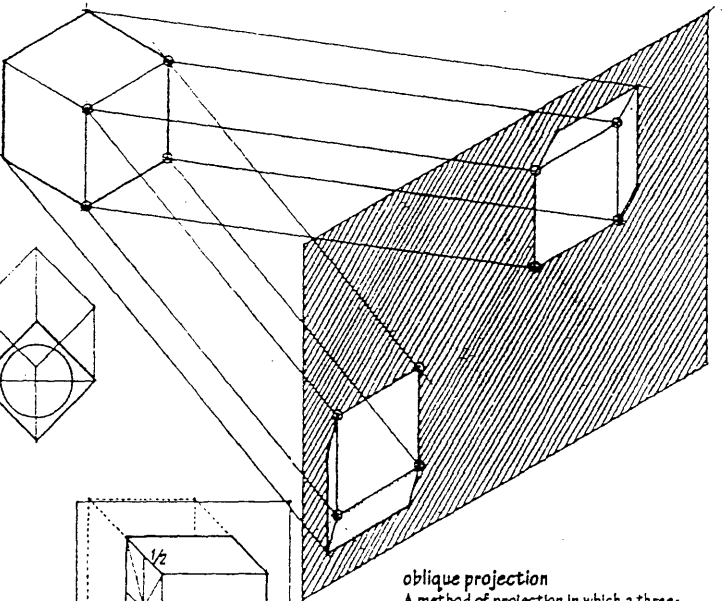


**isometric**

A parallel drawing of an isometric projection, having all lines parallel to the principal axes drawn to true length at the same scale.

**isometric projection**

An axonometric projection of a three-dimensional object having its principal faces equally inclined to the picture plane so that its three principal axes are equally foreshortened.

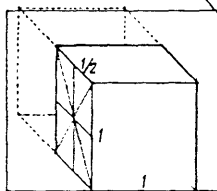


**oblique projection**

A method of projection in which a three-dimensional object, having one principal face parallel to the picture plane, is represented by projecting parallel lines at some angle other than 90° to the picture plane.

**oblique**

A parallel drawing of an oblique projection, having all lines and faces parallel to the picture plane drawn to exact scale, and all receding lines perpendicular to the picture plane shown at any convenient angle other than 90°, sometimes at a reduced scale to offset the appearance of distortion.



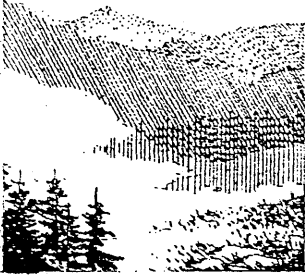
**cabinet drawing**

A parallel drawing of an oblique projection, having all lines parallel to the picture plane drawn to exact scale, and the receding lines perpendicular to the picture plane reduced to half scale.

# DRAWING

## perspective

Any of various techniques for representing three-dimensional objects and spatial relationships on a two-dimensional surface as they might appear to the eye.

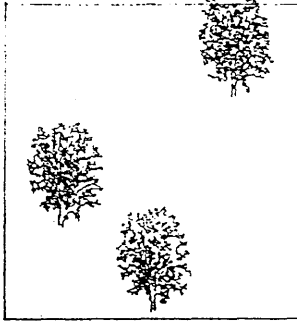


## aerial perspective

A technique for rendering depth or distance by muting the hue, tone, and distinctness of objects perceived as receding from the picture plane. Also called atmospheric perspective.

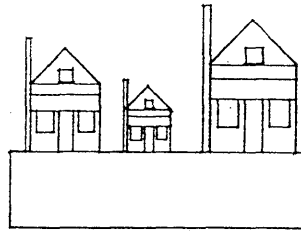
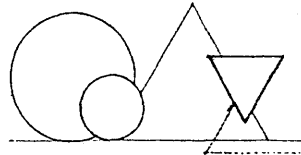
## pictorial space

The illusion of space or depth depicted on a two-dimensional surface by various graphic means, as aerial perspective, continuity of outline, or vertical location.



## vertical location

A technique for representing depth or distance by placing distant objects higher in the picture plane than objects perceived as being closer.



## size perspective

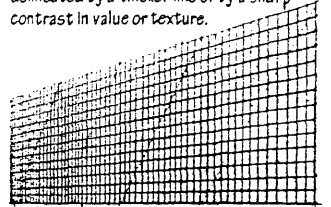
A technique for representing depth or distance by reducing the size of objects perceived as receding from the picture plane.

## continuity of outline

A technique for representing depth or distance by emphasizing the continuity of the contour of a shape perceived as being in front and concealing a part of another behind it.

## spatial edge

An edge of an object or surface separated from its background by an interval of space, delineated by a thicker line or by a sharp contrast in value or texture.



## texture perspective

A technique for representing depth or distance by gradually increasing the density of the texture of a surface perceived as receding from the picture plane.

## linear perspective

A mathematical system for representing three-dimensional objects and spatial relationships on a two-dimensional surface by means of perspective projection.

## perspective projection

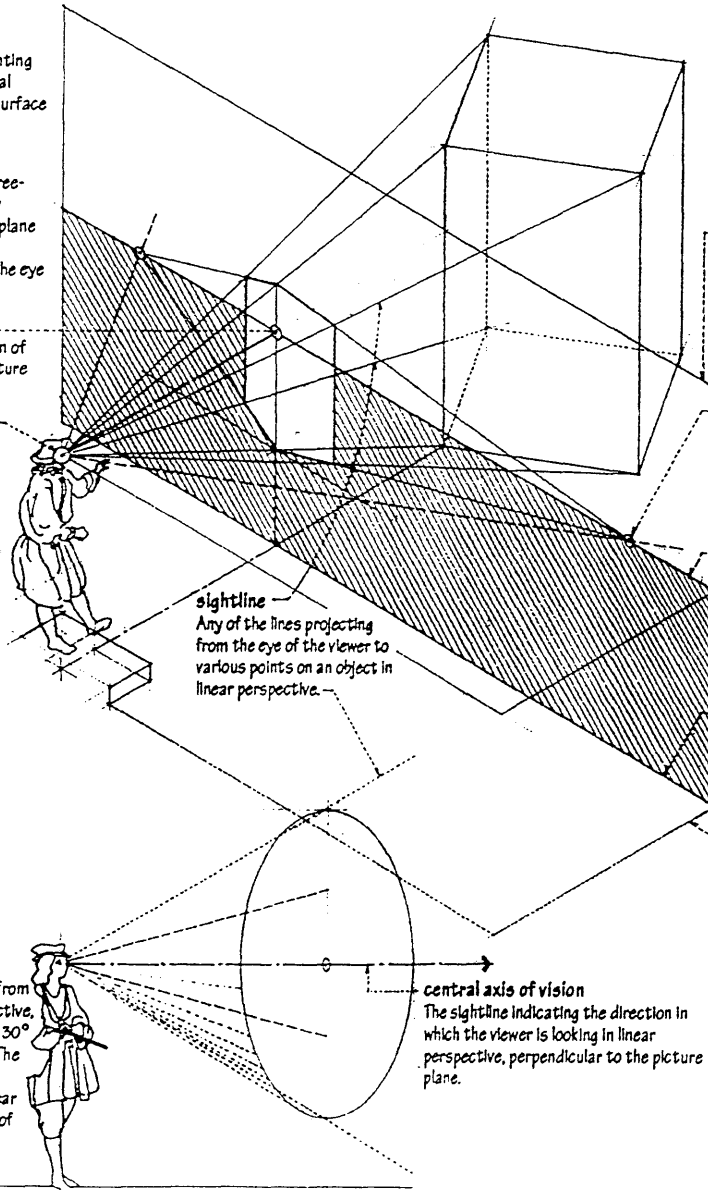
A method of projection in which a three-dimensional object is represented by projecting all its points to a picture plane by straight lines converging at an arbitrarily fixed point representing the eye of the viewer.

## center of vision

A point representing the intersection of the central axis of vision and the picture plane in linear perspective.

## station point

A fixed point in space representing a single eye of the viewer in linear perspective.



## picture plane

An imaginary transparent plane, coincident with the drawing surface, on which the image of a three-dimensional object is projected. In linear perspective, any line or plane coincident with the picture plane can be drawn to exact scale.

## vanishing point

A point toward which receding parallel lines appear to converge in linear perspective, located at the point where a sightline parallel to the set of lines intersects the picture plane.

## horizon line

A line representing the intersection of the picture plane and a horizontal plane through the eye of the viewer in linear perspective.

## ground line

A horizontal line representing the intersection of the ground plane and the picture plane in linear perspective. Also called base line.

## ground plane

A horizontal plane of reference from which vertical measurements can be taken in linear perspective, usually the plane supporting the object depicted or on which the viewer stands.

## cone of vision

The field of vision radiating outward from the eye of the viewer in linear perspective, defined by sightlines forming a  $15^\circ$  to  $30^\circ$  angle with the central axis of vision. The cone of vision serves as a guide in determining what can be drawn in linear perspective without the appearance of distortion.

## central axis of vision

The sightline indicating the direction in which the viewer is looking in linear perspective, perpendicular to the picture plane.



**convergence**

The apparent movement of parallel lines toward a common vanishing point as they recede, used in linear perspective to convey an illusion of space and depth.

Parallel lines perpendicular to the picture plane will appear to converge at the center of vision.

Parallel lines parallel to the picture plane retain their orientation and will not appear to converge.

**perspective**

A drawing of the perspective projection of an object or scene, characterized chiefly by convergence and foreshortening.

**foreshortening**

The apparent contraction or distortion of a represented line or shape that is not parallel to the picture plane, conveying an illusion of extension or projection in space.

**diagonal vanishing point**

A vanishing point for a set of horizontal lines receding at a 45° angle to the picture plane in linear perspective. Also called diagonal point, distance point.

horizon line

Parallel lines rising upward as they recede will appear to converge somewhere above the horizon line.

**vanishing trace**

A line along which all sets of receding parallel lines lying in the same or parallel planes will appear to converge in linear perspective.

**measuring point**

A vanishing point for a set of parallel lines used in transferring scaled measurements in the picture plane to lines receding in linear perspective.

Parallel lines which are horizontal but not perpendicular to the picture plane will appear to converge somewhere on the horizon line.

**one-point perspective**

A linear perspective of a rectangular object or volume having a principal face parallel with the picture plane, so that vertical lines parallel to the picture plane remain vertical, horizontal lines parallel to the picture plane remain horizontal, and horizontal lines perpendicular to the picture plane appear to converge at the center of vision.

**isocephalic**

Having the heads of all figures at approximately the same level. Also, isocephalous.

**two-point perspective**

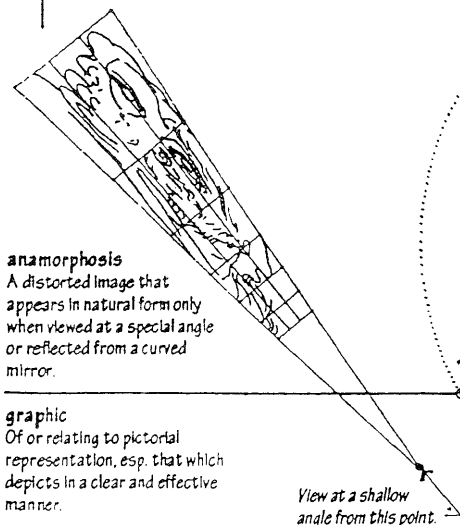
A linear perspective of a rectangular object or volume having two principal faces oblique to the picture plane, so that vertical lines parallel to the picture plane remain vertical and two horizontal sets of parallel lines oblique to the picture plane appear to converge at two vanishing points, one to the left and the other to the right.

**measuring line**

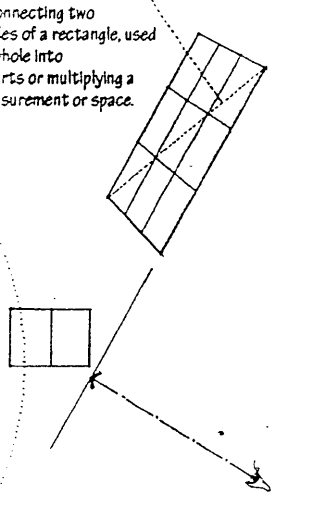
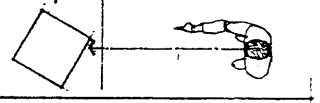
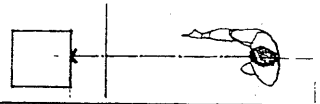
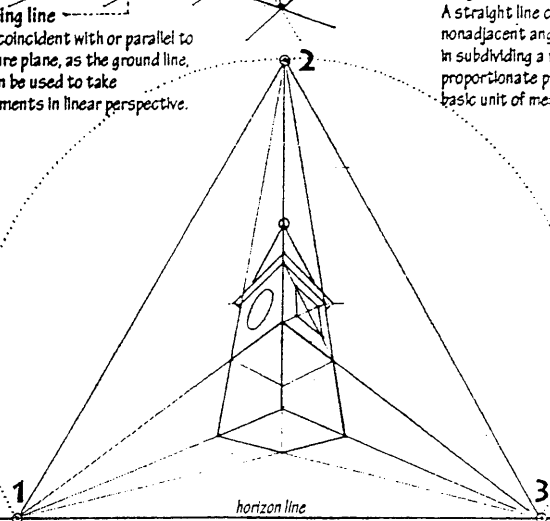
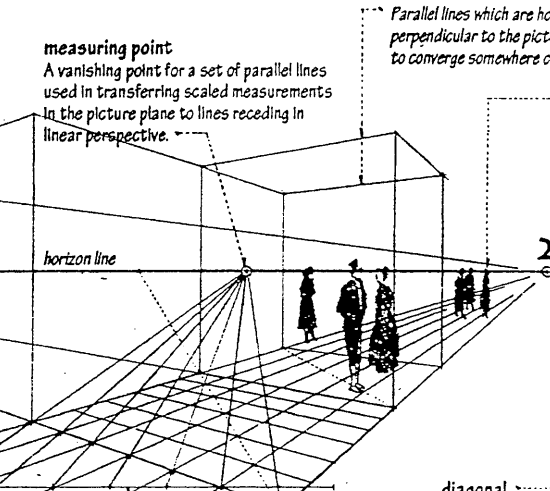
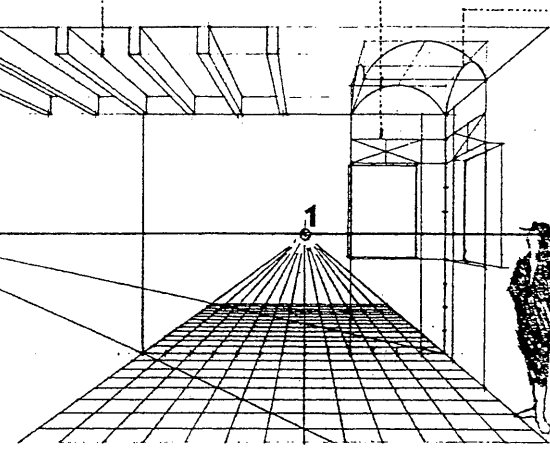
Any line coincident with or parallel to the picture plane, as the ground line, which can be used to take measurements in linear perspective.

**diagonal**

A straight line connecting two nonadjacent angles of a rectangle, used in subdividing a whole into proportionate parts or multiplying a basic unit of measurement or space.



**graphic**  
Of or relating to pictorial representation, esp. that which depicts in a clear and effective manner.



**three-point perspective**  
A linear perspective of a rectangular object or volume having all principal faces oblique to the picture plane, so that the three principal sets of parallel lines appear to converge at three different vanishing points.

# ELECTRICITY

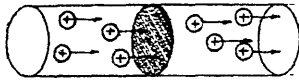
The science dealing with the physical phenomena arising from the existence and interaction of electric charges.

## electric charge

The intrinsic property of matter giving rise to all electric phenomena, occurring in two forms arbitrarily given positive and negative algebraic signs and measured in coulombs. Opposite charges attract while like charges repel each other.

## coulomb

The SI unit of electric charge, equal to the quantity of electricity transferred across a conductor by a current of one ampere in one second. Abbr.: C



## electromotive force

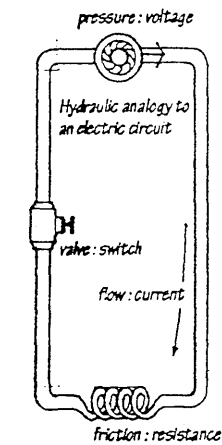
The energy per unit charge available for conversion from a chemical, mechanical, or other form of energy into electrical energy, or vice versa, in a conversion device as a battery, generator, or motor. Abbr.: emf

## potential difference

The voltage difference between two points that represents the work involved in the transfer of a unit charge from one point to the other.

## potential

The work required to move a unit charge from a reference point to a designated point.



$$W = V \times A$$

## power

The product of potential difference and current in a direct-current circuit. In an alternating current circuit, power is equal to the product of the effective voltage, the effective current, and the cosine of the phase angle between current and voltage.

## watt

The SI unit of power, equal to one joule per second or to the power represented by a current of one ampere flowing across a potential difference of one volt. Abbr.: W

## wattage

An amount of power, esp. the power required to operate an electrical device or appliance, expressed in watts.

## kilowatt

A unit of power, equal to 1,000 watts. Abbr.: kW

## kilowatt-hour

A unit of energy, equal to the energy transferred or expended by one kilowatt in one hour; a common unit of electric power consumption. Abbr.: kWh

## voltage

Potential difference or electromotive force expressed in volts; analogous to pressure in water flow.

## volt

The SI unit of potential difference and electromotive force, defined as the difference of electric potential between two points of a conductor carrying a constant current of one ampere, when the power dissipated between the points is equal to one watt. Abbr.: V

## current

The rate of flow of electric charge in a circuit per unit time, measured in amperes.

*Before the nature of electricity was fully understood, it was assumed that a direct current flowed from a positive point to a negative one. This convention is still used even though electrons flow in the opposite direction, from negative to positive.*

## ampere

The basic SI unit of electric current, equivalent to a flow of one coulomb per second or to the steady current produced by one volt applied across a resistance of one ohm. Abbr.: A

## amperage

The strength of an electric current measured or expressed in amperes; analogous to the rate of water flow.

## circuit

The complete path of an electric current, including the source of electric energy.

## series

An arrangement of components in an electric circuit in which the same current flows through each component in turn without branching.

## parallel

An arrangement of components in an electric circuit in which all positive terminals are connected to one conductor and all negative terminals are connected to a second conductor, the same voltage being applied to each component.

## resistance

The opposition of a conductor to the flow of current, causing some of the electric energy to be transformed into heat and usually measured in ohms. Abbr.: R

## ohm

The SI unit of electrical resistance, equal to the resistance of a conductor in which a potential difference of one volt produces a current of one ampere. Symbol:  $\Omega$

## Ohm's law

The law that for any circuit the electric current is directly proportional to the voltage and inversely proportional to the resistance.

## Joule's law

The principle that the rate of production of heat by a direct current is directly proportional to the resistance of the circuit and to the square of the current.

## battery

A group of two or more cells connected together to produce electric current.

## cell

A device for converting chemical into electric energy, usually consisting of a receptacle with electrodes in an electrolyte. Also called **electric cell**, **galvanic cell**, **voltaic cell**.

## electrolyte

A nonmetallic conducting medium in which current is carried by the movement of ions.

## electrode

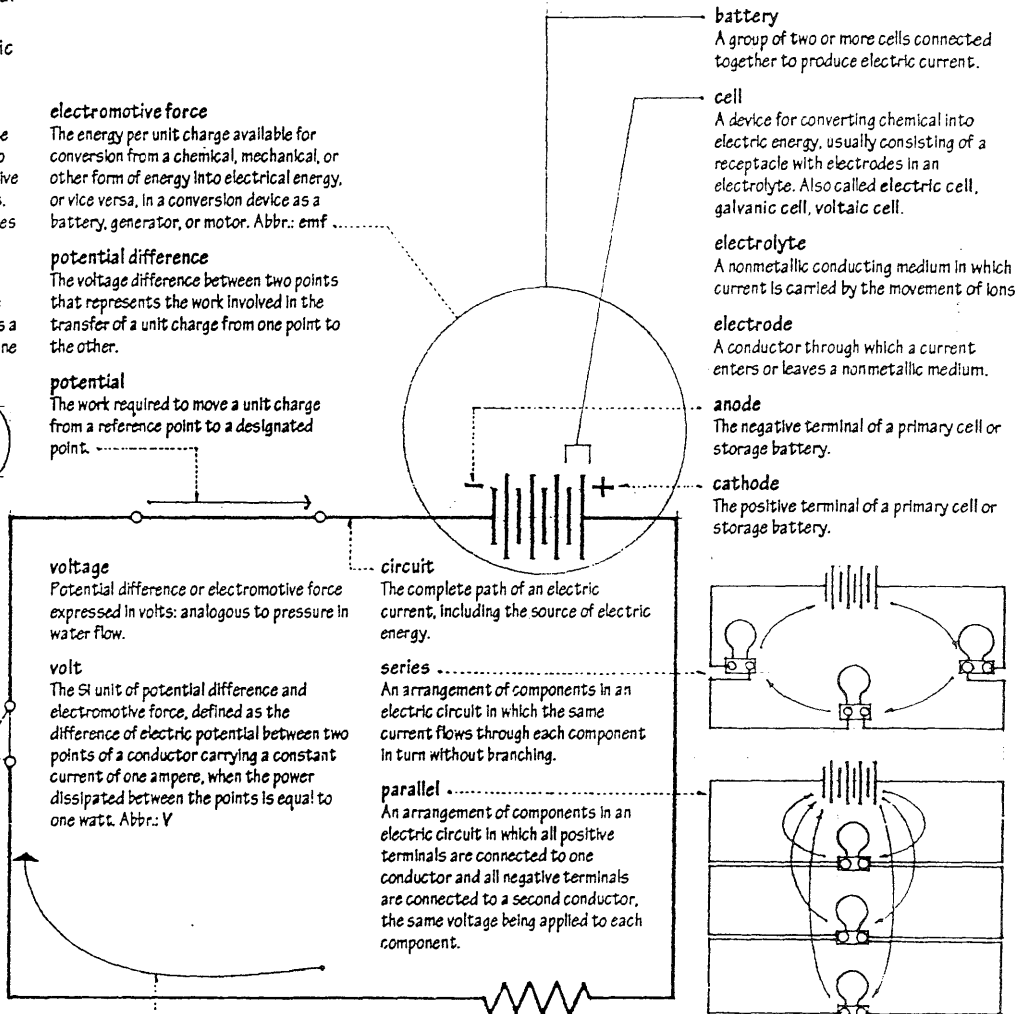
A conductor through which a current enters or leaves a nonmetallic medium.

## anode

The negative terminal of a primary cell or storage battery.

## cathode

The positive terminal of a primary cell or storage battery.



## resistivity

The resistance per unit length of a substance with a unit cross-sectional area. Also called **specific resistance**.

## conductivity

A measure of the ability of a substance to conduct electric current, equal to the reciprocal of the resistivity of the substance. Also called **specific conductance**.

$$I = V/R$$

**generator**  
A machine that converts mechanical energy into electrical energy.

**alternator**  
A generator for producing alternating current.

**electric motor**  
A machine that converts electric power into mechanical energy.

**armature**  
The main current-carrying winding of a motor or generator in which electromotive force is induced.

**brush**  
A copper or carbon conductor serving to maintain electric contact between fixed and moving elements in a motor or generator.

**core**  
A mass of iron or other ferrous material in an electromagnet, induction coil, or transformer, serving to concentrate and intensify the magnetic field resulting from a current in a surrounding coil.

**coil**  
A conductor wound in a spiral form to introduce inductance into a circuit.

**direct current**  
An electric current flowing in one direction only and having a magnitude that does not vary or varies only slightly. Abbr.: DC

**alternating current**  
An electric current that reverses direction at regularly recurring intervals, having a magnitude that varies in a sinusoidal manner. Abbr.: AC

**volt-ampere**  
A unit of electric measurement, equal to the product of one volt and one ampere, equivalent to one watt for direct-current systems and a unit of apparent power for alternating-current systems. Abbr.: VA

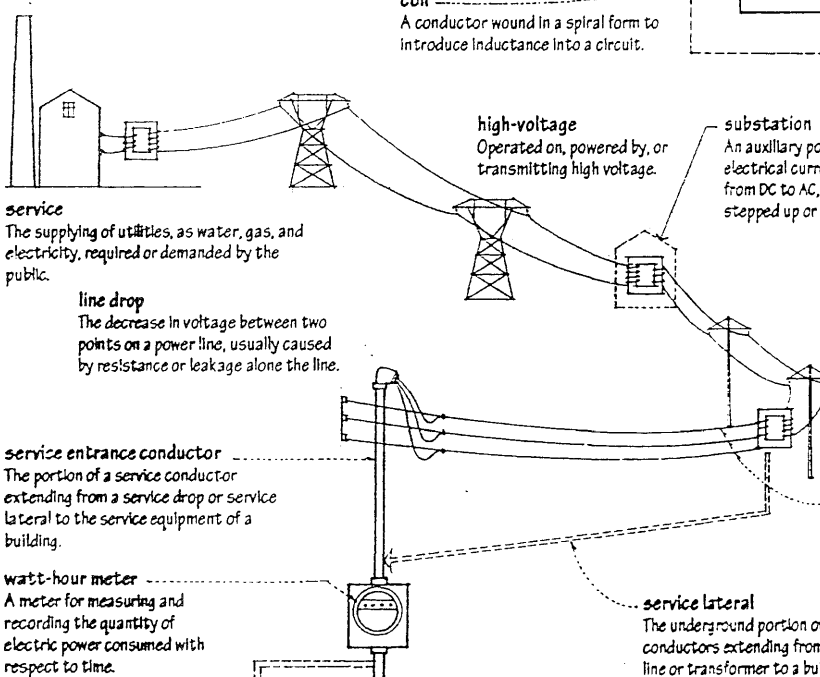
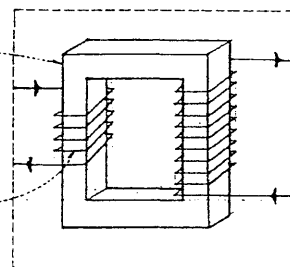
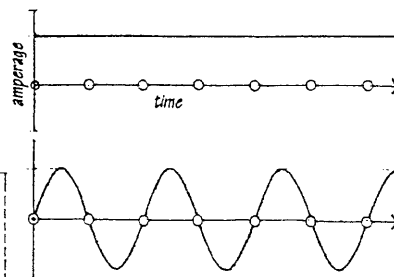
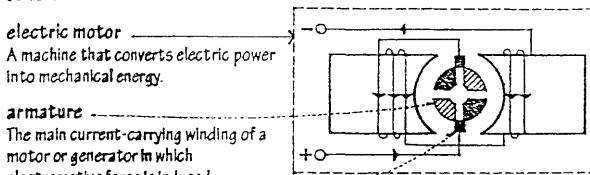
**transformer**  
An electric device consisting of two or more windings wound on the same core, which employs the principle of mutual induction to convert variations of alternating current in a primary circuit into variations of voltage and current in a secondary circuit.

**step-up transformer**  
A transformer having fewer turns in the primary winding than in the secondary, serving to transform low voltage to high voltage.

**step-down transformer**  
A transformer having a greater number of turns in the primary winding than in the secondary, serving to transform high voltage to low voltage.

**line voltage**  
The voltage supplied by a power line, measured at the point of use.

**service conductor**  
Any of several conductors extending from a main power line or transformer to the service equipment of a building.



**service**  
The supplying of utilities, as water, gas, and electricity, required or demanded by the public.

**line drop**  
The decrease in voltage between two points on a power line, usually caused by resistance or leakage along the line.

**service entrance conductor**  
The portion of a service conductor extending from a service drop or service lateral to the service equipment of a building.

**watt-hour meter**  
A meter for measuring and recording the quantity of electric power consumed with respect to time.

**high-voltage**  
Operated on, powered by, or transmitting high voltage.

**substation**  
An auxiliary power station where electrical current is converted, as from DC to AC, or where voltage is stepped up or down.

**service drop**  
The overhead portion of service conductors extending from the nearest utility pole to a building.

**service lateral**  
The underground portion of service conductors extending from a main power line or transformer to a building.

**feeder**  
Any of the conductors extending from the service equipment to various distribution points in a building.

**transformer vault**  
A fire-rated room housing a transformer and auxiliary equipment for a large building, usually located on grade or below ground and ventilated directly to the outside air.

**switchgear room**  
A room containing the service equipment for a large building.

**service equipment**  
The equipment necessary for controlling, metering, and protecting the electric power supply to a building, located near the entrance of the service conductors and usually consisting of a main disconnect switch and secondary switches, fuses, and circuit breakers.

**standby generator**  
A generator for providing emergency power during a power outage. Also called emergency generator.

**uninterruptible power supply**  
An emergency system designed to provide power automatically and instantaneously upon failure of the normal power supply.

**switchboard**  
One or a group of panels on which are mounted switches, overcurrent devices, metering instruments, and buses for controlling and protecting a number of electric circuits. Also called switchgear.

**unit substation**  
A freestanding enclosure housing a disconnect switch, a step-down transformer, and switchgear for a number of electric circuits.

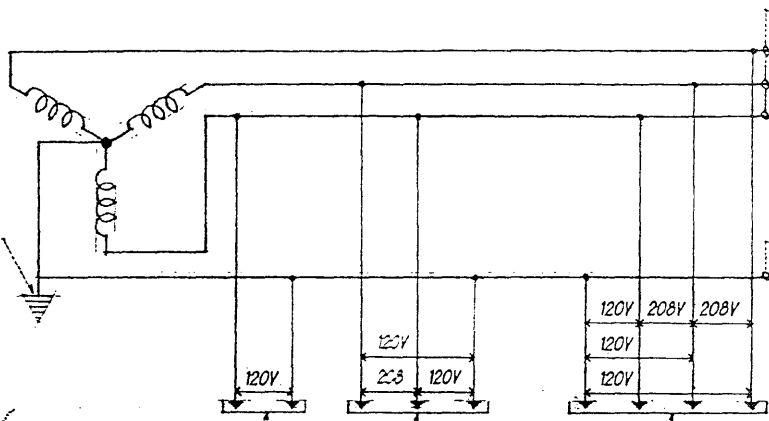
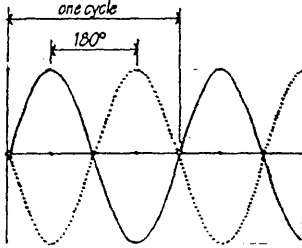
# ELECTRICITY

## phase

The fractional part of a period or cycle through which time has advanced, measured from a specified reference point and often expressed as an angle.

## ground

A conducting connection between an electric circuit or device and the earth or other point of zero potential.



## single-phase

Of or pertaining to a circuit energized by an alternating current with one phase or with phases differing by 180°.

## two-phase

Of or pertaining to a circuit energized by two alternating currents or voltages differing in phase by one quarter of a cycle or 90°.

## three-phase

Of or pertaining to a combination of three circuits energized by alternating currents or voltages differing in phase by one third of a cycle or 120°.

## live

Electrically connected to a source of voltage, or electrically charged so as to have a potential different from that of earth. Also, hot.

## dead

Not electrically connected to a source of voltage.

## neutral

Not electrically charged.

## fault

A local failure in the insulation or continuity of a conductor, or in the functioning of an electrical system.

## short circuit

An abnormal, usually accidental condition of low resistance between two points in an electric circuit, resulting in a flow of excess current. Also called short.

## shock

The muscular spasms caused by an electric current passing through the body.

## service switch

The main disconnect for the entire electrical system of a building, except for any emergency power systems.

## panel

A board on which are mounted the switches, fuses, and circuit breakers for controlling and protecting a number of similar branch circuits, installed in a cabinet and accessible from the front only. Also called panelboard.

## bus

A heavy conductor, usually in the form of a solid copper bar, used for collecting, carrying, and distributing large electric currents. Also called busbar.

## grounded conductor

Any conductor of an electrical system intentionally connected to a ground connection.

## grounding electrode

A conductor, as a metal ground rod, ground plate, or cold-water pipe, firmly embedded in the earth to establish a ground connection.

## ground wire

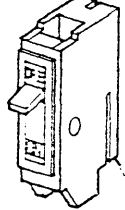
A conductor connecting electric equipment or a circuit to a ground connection. Also called grounding conductor.

## fuse

A device containing a strip or wire of fusible metal that melts under the heat produced by excess current, thereby interrupting the circuit.

## fusible metal

Any of various metal alloys having a melting point below 300°F (150°C), used as solder and in various safety devices. Also called fusible alloy.



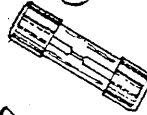
## circuit breaker

A switch that automatically interrupts an electric circuit to prevent excess current from damaging apparatus in the circuit or from causing a fire. A circuit breaker may be reset and reused without replacement of any components. Also called breaker.



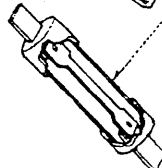
## plug fuse

A fuse housing a fusible link in a porcelain cup fitted with a threaded metal base.



## cartridge fuse

A fuse having a one-time or renewable fusible link enclosed in an insulating fiber tube.



## knife-blade fuse

A cartridge fuse having a metal blade at each end for making contact with the fusible link within.

## time-delay fuse

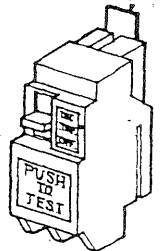
A fuse that delays opening to allow a short-term overload to pass, as when starting a motor.

## ground fault

A momentary, usually accidental, grounding of a conducting wire.

## ground-fault interrupter

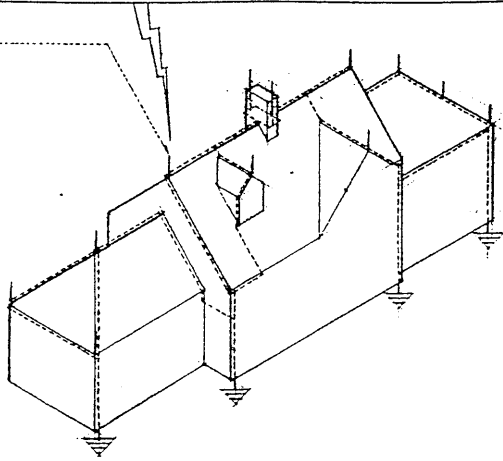
A circuit breaker that senses currents caused by ground faults and instantaneously shuts off power before damage or injury can occur. Abbr.: gfi



**lightning rod**  
Any of several conducting rods installed at the top of a structure and grounded to divert lightning away from the structure. Also called air terminal.

**lightning arrester**  
A device for protecting electric equipment from damage by lightning or other high-voltage currents, using spark gaps to carry the current to the ground without passing through the device.

**spark gap**  
A space between two terminals or electrodes, across which a discharge of electricity may pass at a prescribed voltage.



**load**  
The power delivered by a generator or transformer, or the power consumed by an appliance or device.

**connected load**  
The total load on an electrical system or circuit if all connected apparatus and equipment are energized simultaneously.

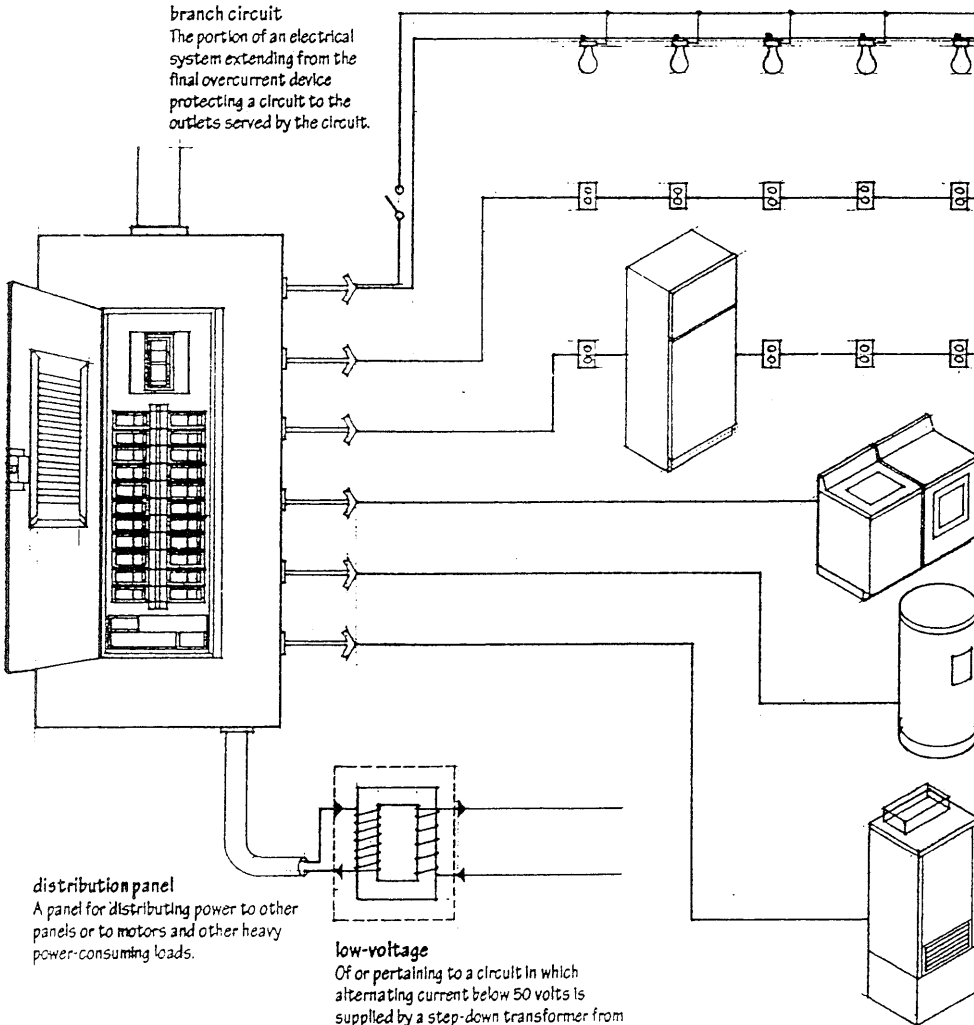
**maximum demand**  
The greatest load delivered to an electrical system or circuit over a specified interval of time.

**demand factor**  
The ratio of the maximum demand to the connected load of an electrical system, used in estimating the required capacity of the system to account for the probability that only a portion of the connected load may be applied at any time.

**diversity factor**  
The ratio of the sum of the maximum demands on the various parts of an electrical system to the maximum demand on the whole.

**load factor**  
The ratio of the average load on an electrical system over a specific period of time to the peak load occurring in that period.

**branch circuit**  
The portion of an electrical system extending from the final overcurrent device protecting a circuit to the outlets served by the circuit.



**general purpose circuit**  
A branch circuit that supplies current to a number of outlets for lighting and appliances.

**appliance circuit**  
A branch circuit that supplies current to one or more outlets specifically intended for appliances.

**individual circuit**  
A branch circuit that supplies current only to a single piece of electrical equipment.

**distribution panel**  
A panel for distributing power to other panels or to motors and other heavy power-consuming loads.

**low-voltage**  
Of or pertaining to a circuit in which alternating current below 50 volts is supplied by a step-down transformer from the normal line voltage, used in residential systems to control doorbells, intercoms, heating and cooling systems, and remote lighting fixtures. Low-voltage circuits do not require a protective raceway.

# ELECTRICITY

**cable**  
A single insulated conductor or a bound or sheathed combination of conductors insulated from one another.

**armored cable**  
Electric cable consisting of two or more insulated conductors protected by a flexible, helically wound metal wrapping. Also called BX cable.

**mineral-insulated cable**  
Electric cable consisting of a tubular copper sheath containing one or more conductors embedded in a highly compressed, insulating refractory mineral.

**nonmetallic sheathed cable**  
Electric cable consisting of two or more insulated conductors enclosed in a nonmetallic, moisture-resistant, flame-retardant sheath. Also called Romex cable.

**coaxial cable**  
A cable for transmitting high-frequency telephone, digital, or television signals, consisting of an insulated conducting tube enclosing an insulated conducting core.

**shielded cable**  
An electric cable enclosed within a metallic sheath in order to reduce the effects of external electric or magnetic fields.

**conduit**  
A tube, pipe, or duct for enclosing and protecting electric wires or cable.

**rigid metal conduit**  
Heavy-walled, tubular steel conduit joined by screwing directly into a threaded hub with locknuts and bushings.

**electrical metallic tubing**  
Thin-walled, tubular steel conduit joined by compression or setscrew couplings. Abbr.: EMT

**flexible metal conduit**  
A flexible, helically wound metal conduit, used for connections to motors or other vibrating equipment. Also called Greenfield conduit.

**raceway**  
A channel expressly designed to hold and protect electric wires and cables.

**surface raceway**  
A raceway designed for exposed installation in dry, nonhazardous, noncorrosive locations.

**multi-outlet assembly**  
A surface-mounted raceway designed to house the electrical wires for a circuit and a series of receptacles.

**underfloor raceway**  
A raceway suitable for installation under a floor, often used in office buildings to allow for the flexible placement of power, signal, and telephone outlets.

**wire**  
A pliable metallic strand or a twisted or woven assembly of such strands, often insulated with a dielectric material and used as a conductor of electricity.

**conductor**  
A substance, body, or device that conducts heat, sound, or electricity.

**insulator**  
A material that is a poor conductor of electricity, used for separating or supporting conductors to prevent the undesired flow of current.

**breakdown voltage**  
The minimum applied voltage at which a given insulator breaks down and permits current to pass.

**dielectric strength**  
The maximum voltage that can be applied to a given material without causing it to break down, usually expressed in volts or kilovolts per unit of thickness.

**dielectric**  
A nonconducting substance.

**junction box**  
An enclosure for housing and protecting electric wires or cables that are joined together in connecting or branching electric circuits.

**knockout**  
A panel in a casing or box that can readily be removed, as by punching, hammering, or cutting, to provide an opening into the interior.

**grommet**  
A rubber or plastic washer inserted in a hole in a metal part to prevent grounding of a wire passing through the hole.

**bushing**  
An insulating and protective lining for one or more conductors passing through a hole.

**duct**  
An enclosed runway for housing conductors or cables.

**bus duct**  
A rigid metal housing for a group of buses insulated from each other and the enclosure. Also called busway.

**cable tray**  
An open metal framework for supporting insulated electrical conductors.

**air switch**

A switch in which the interruption of a circuit occurs in air.

**knife switch**

A form of air switch in which a hinged copper blade is placed between two contact clips.

**float switch**

A switch controlled by a conductor floating in a liquid.

**mercury switch**

An especially quiet switch that opens and closes an electric circuit by shifting a sealed glass tube of mercury so as to uncover or cover the contacts.

**key switch**

A switch operated only by inserting a key.

**dimmer**

A rheostat or similar device for regulating the intensity of an electric light without appreciably affecting spatial distribution. Also called *dimmer switch*.

**rheostat**

A resistor for regulating a current by means of variable resistances.

**knob-and-tube wiring**

An obsolete wiring system consisting of single, insulated conductors secured to and supported on porcelain knobs and tubes.

**loom**

A flexible, nonmetallic, fire-resistant tubing for conductors in knob-and-tube wiring.

**lead**

A flexible, insulated conductor for electrically connecting an apparatus to another or to a circuit.

**pigtail**

A short, flexible conductor used in connecting a stationary terminal with a terminal having a limited range of motion.

**terminal**

A conductive element or device for establishing an electric connection to an apparatus.

**faceplate**

A protective plate surrounding an electric outlet or light switch.

**switch**

A device for making, breaking, or directing an electric current.

**toggle switch**

A switch in which a lever or knob, moving through a small arc, causes the contacts to open or close an electric circuit.

**three-way switch**

A single-pole, double-throw switch used in conjunction with another to control lights from two locations.

**four-way switch**

A switch used in conjunction with two three-way switches to control lights from three locations.

**outlet**

A point on a wiring system at which current is taken to supply an electric device or apparatus.

**outlet box**

A junction box designed to facilitate connecting an electric device or receptacle to a wiring system.

**convenience outlet**

An outlet usually mounted on a wall and housing one or more receptacles for portable lamps or appliances.

**receptacle**

A female fitting connected to a power supply and equipped to receive a plug. Also called *socket*.

**grounding outlet**

An outlet having an additional contact for a ground connection.

**plug**

A male fitting for making an electrical connection to a circuit by insertion in a receptacle.

**grounding plug**

A plug having a blade for a ground connection.

**polarized**

Designed so that a plug and receptacle can fit together in only one way.

**cord**

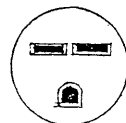
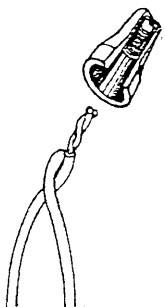
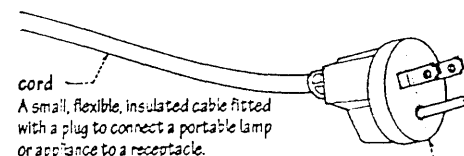
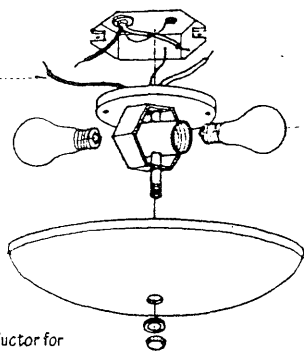
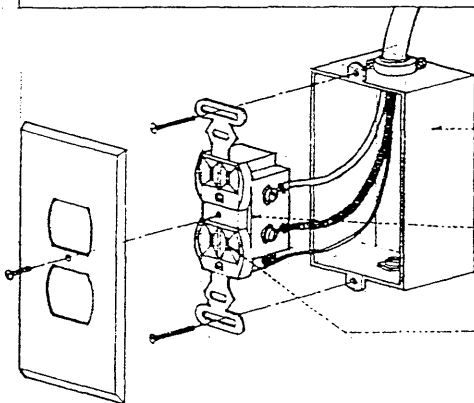
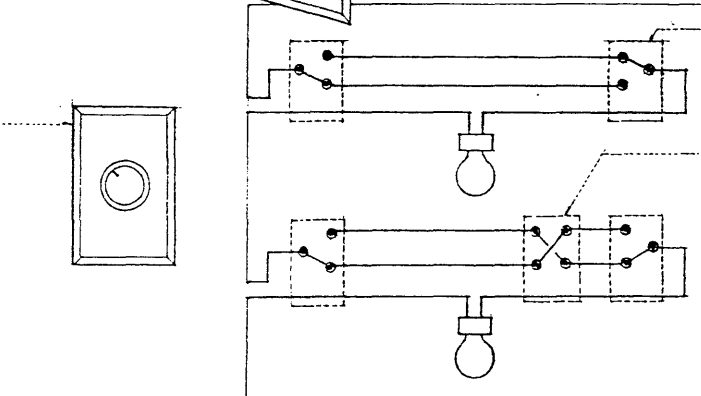
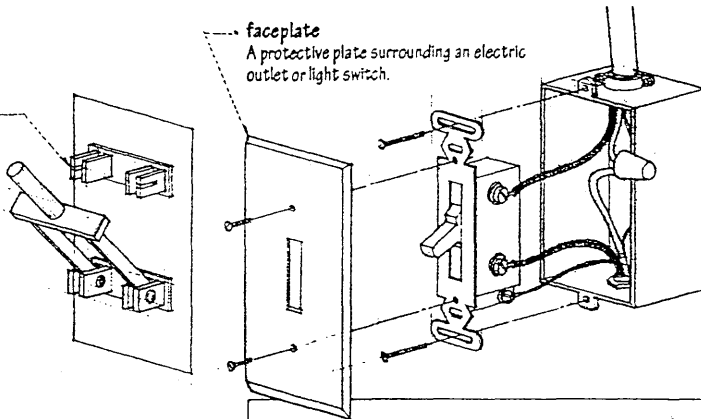
A small, flexible, insulated cable fitted with a plug to connect a portable lamp or appliance to a receptacle.

**wire nut**

A plastic connector containing a threaded metal fitting for screwing onto the intertwined ends of two or more conductors.

**connector**

Any of various devices for joining two or more conductors without a permanent splice



# ELEVATOR

A moving platform or cage for carrying passengers or freight from one level of a building to another.

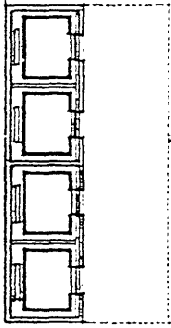
**lift**  
British term for elevator.

**passenger elevator**  
An elevator exclusively for the use of passengers.

**freight elevator**  
An elevator for carrying heavy cargo, on which the operator and the persons necessary for unloading and loading the freight are permitted to ride.

**dumbwaiter**  
A small elevator for conveying food, dishes, or other materials between the floors of a building.

**bank**  
A row of elevators in a high-rise building, controlled by a common operating system and responding to a single call button.



**rise**  
The vertical distance traversed by an elevator car from the lowest to the highest landings of the hoistway. Also called travel.

**electric elevator**  
An elevator system consisting of a car that is mounted on guide rails, supported by hoisting cables, and driven by electric hoisting machinery. Also called traction elevator.

**penthouse**  
A structure housing elevator machinery on the roof of a building.

**top car clearance**  
The vertical distance from the top of an elevator car to the nearest overhead obstruction when the car platform is level with the top landing.

**hoistway**  
A vertical enclosed space for the travel of one or more elevators. Also called elevator shaft.

**landing**  
The portion of a floor adjacent to an elevator hoistway, used for the receiving and discharge of passengers or freight.

**elevator car safety**  
A mechanical device for slowing down and stopping an elevator car in the event of excessive speed or free fall, actuated by a governor and clamping the guide rails by a wedging action.

**hoistway door**  
A door between a hoistway and an elevator landing, normally closed except when an elevator car is stopped at the landing.

**elevator pit**  
The portion of a hoistway extending from the level of the lowest landing to the floor of the hoistway.

**bottom car clearance**  
The vertical distance from the floor of an elevator pit to the lowest part of an elevator car platform when the car rests on fully compressed buffers.

**bulkhead**  
A boxlike structure on a roof providing access to a stairwell or an elevator shaft.

**control panel**  
A panel containing switches, buttons, and other equipment for regulating electrical devices.

**hoisting machinery**  
The machinery for raising and lowering an elevator car, consisting of a motor-generator set, traction machine, speed governor, brake, drive shaft, driving sheave, and gears, if used.

**driving sheave**  
A wheel or disk with a grooved rim, used as a pulley for hoisting.

**idle sheave**  
A pulley for tightening and guiding the hoisting cables of an elevator system. Also called deflector sheave.

**machine beam**  
One of the heavy steel beams supporting the hoisting machinery for an elevator.

**hoisting cable**  
One of the wire cables or ropes used for raising and lowering an elevator car.

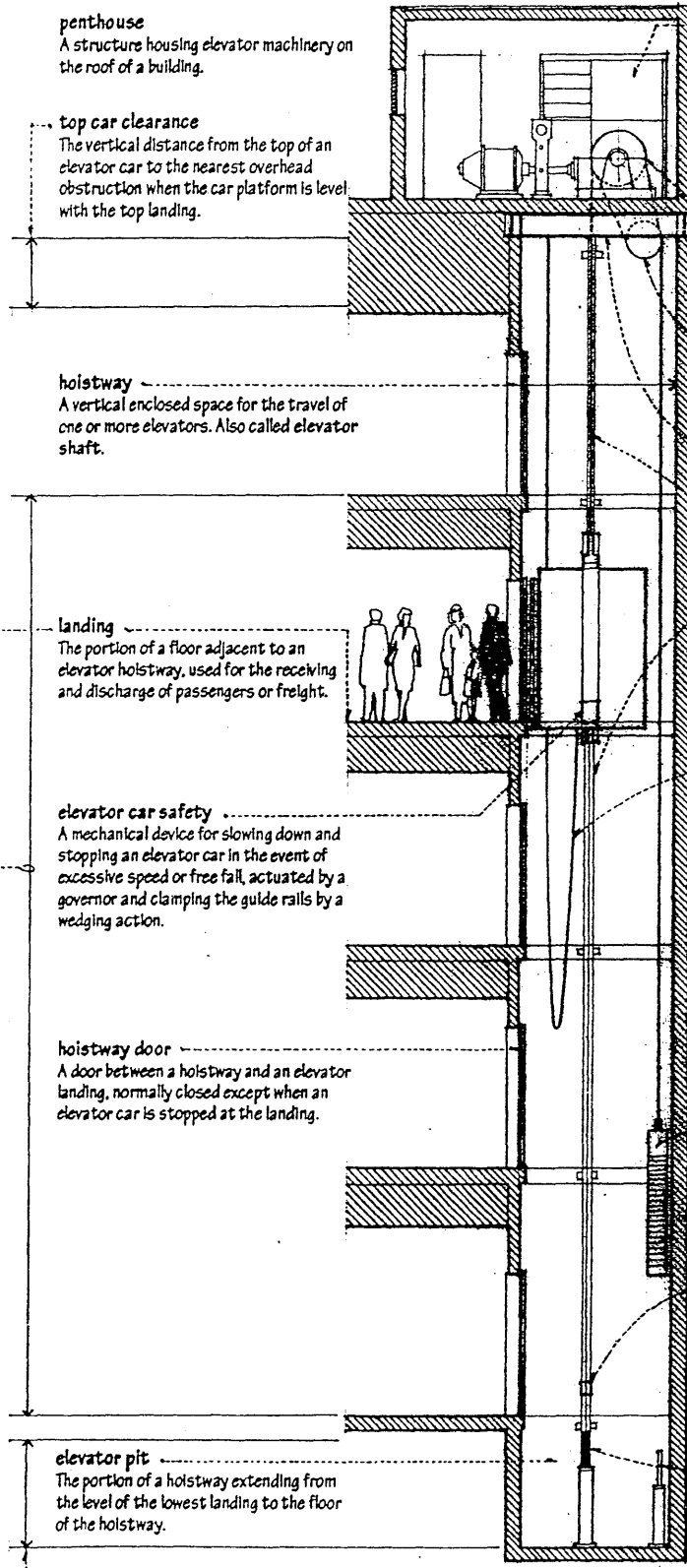
**guide rail**  
One of the vertical steel tracks controlling the travel of an elevator car or counterweight.

**traveling cable**  
One of the electric cables connecting an elevator car to a fixed electrical outlet in the hoistway.

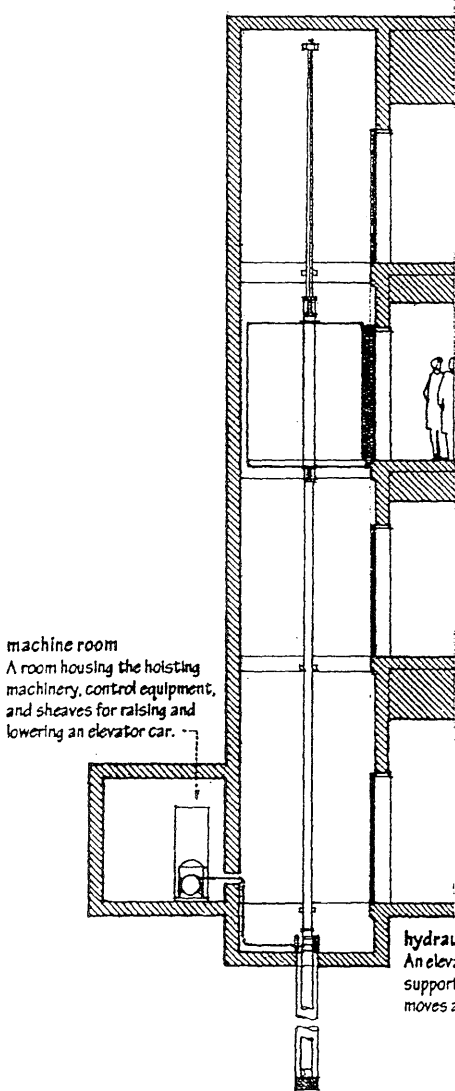
**counterweight**  
A weight balancing another weight, as the rectangular cast-iron blocks mounted in a steel frame to counterbalance the load placed on the hoisting machine by an elevator car.

**limit switch**  
A switch that automatically cuts off current to an electric motor when an object moved by it, as an elevator car, has passed a given point.

**buffer**  
A piston or spring device for absorbing the impact of a descending elevator car or counterweight at the extreme lower limit of travel.

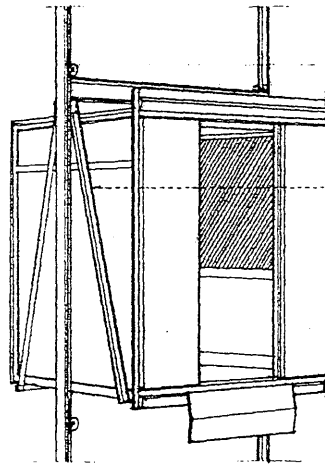






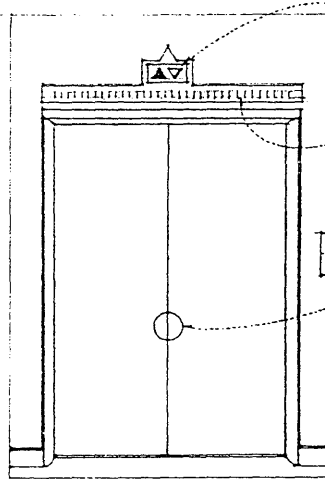
**machine room**  
A room housing the hoisting machinery, control equipment, and sheaves for raising and lowering an elevator car.

**hydraulic elevator**  
An elevator system consisting of a car supported by a piston that is moved by or moves against a fluid under pressure.



**elevator car**  
The load-carrying unit of an elevator, consisting of a car frame, platform, light metal enclosure, and door or gate.

**car frame**  
The structural steel frame of an elevator car to which are attached the platform, guide shoes, elevator car safety, hoisting cables, and control equipment.



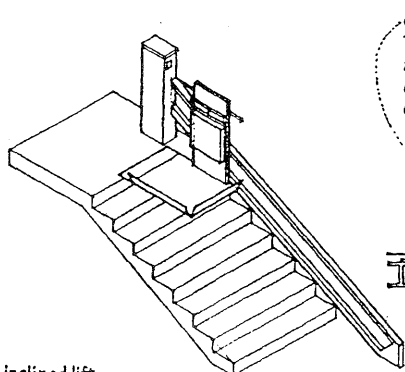
**lantern**  
A light, usually over the entrance to an elevator on each floor of a multistory building, that signals the approach of the elevator.

**annunciator**  
A signaling apparatus in an elevator car or at a landing that displays a visual indication of floor landings.

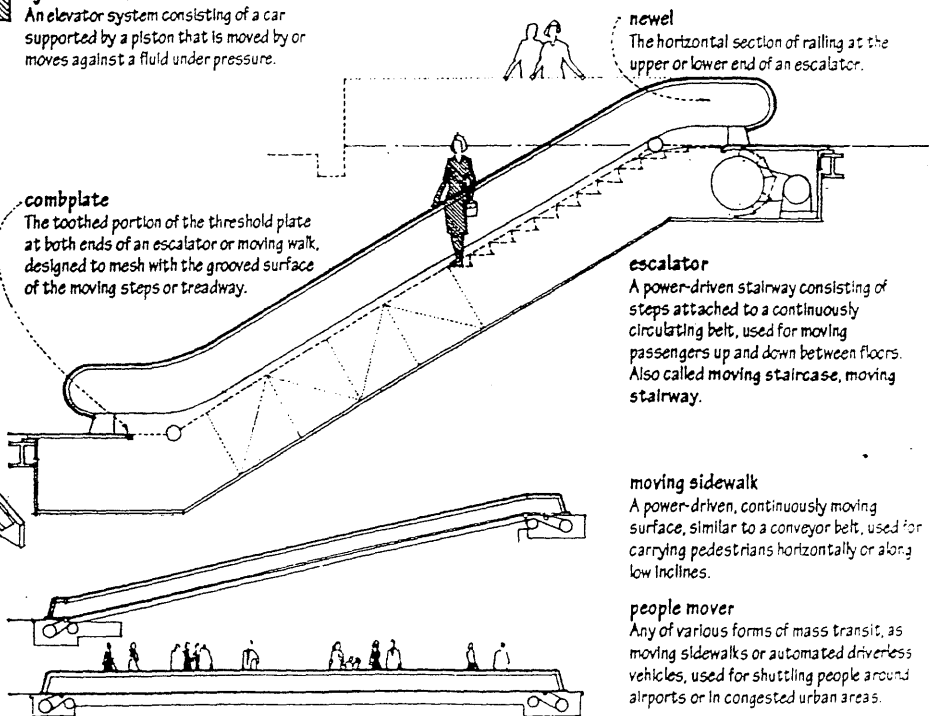
**call button**  
A push button for requesting an elevator.

**door interlock**  
A safety device for preventing the operation of an elevator car unless the hoistway door is locked in the closed position.

**door contact**  
A safety device for preventing the operation of an elevator car unless its door or gate is fully closed. Also called gate contact.



**inclined lift**  
A chair or platform mounted on a steel guide rail and driven by an electric motor, used for raising or lowering a person or goods along a stairway. Also called stair lift.



**complate**  
The toothed portion of the threshold plate at both ends of an escalator or moving walk, designed to mesh with the grooved surface of the moving steps or treadway.

**newel**  
The horizontal section of railing at the upper or lower end of an escalator.

**escalator**  
A power-driven stairway consisting of steps attached to a continuously circulating belt, used for moving passengers up and down between floors. Also called moving staircase, moving stairway.

**moving sidewalk**  
A power-driven, continuously moving surface, similar to a conveyor belt, used for carrying pedestrians horizontally or along low inclines.

**people mover**  
Any of various forms of mass transit, as moving sidewalks or automated driverless vehicles, used for shuttling people around airports or in congested urban areas.

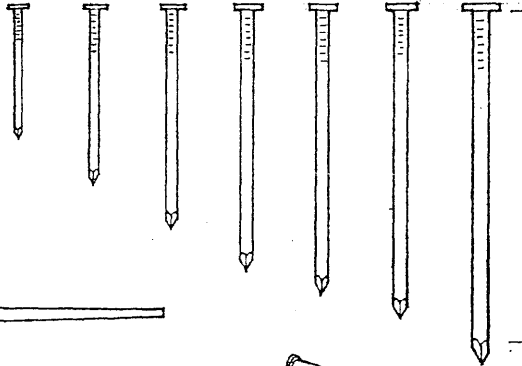
# FASTENING

Holding together or uniting two or more parts or members, as by clamping with a mechanical fastener, by bonding with an adhesive, or by welding or soldering.

4d	6d	8d	10d	12d	16d	20d	penny
1½"	2"	2½"	3"	3¼"	3½"	4"	The designated length of a nail, from twopenny to sixty penny. Symbol: d
38 mm	51 mm	64 mm	76 mm	83 mm	89 mm	102 mm	

## nail

A straight, slender piece of metal having one end pointed and the other enlarged and flattened for hammering into wood or other building materials as a fastener.



## shank

The straight, narrow part of a nail or bolt, between the head and the point.

## eightpenny nail

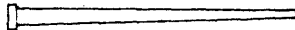
A nail 2½ inches (64 mm) long.

## sixteenpenny nail

A nail 3½ inches (89 mm) long.

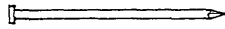
## cut nail

A nail having a tapering rectangular shank with a blunt point, made by cutting from a rolled sheet of iron or steel.



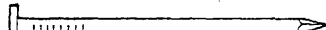
## wire nail

A nail made by cutting and shaping a piece of round or elliptical wire.



## common nail

A nail having a slender shank, a flat head, and a diamond point.



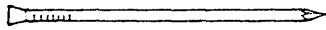
## box nail

A nail having a flat head and a shank more slender than a common nail of the same length.



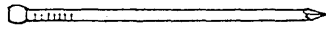
## casing nail

A nail having a small conical head and a shank more slender than a common nail of the same length, used in finish work in which the head may remain visible.



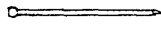
## finishing nail

A nail having a slender shank and a small, barrel-shaped head that is driven slightly below the surface and covered with putty or the like.



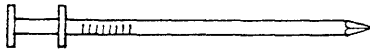
## brad

A small finishing nail.



## double-headed nail

A nail used in building temporary structures, as scaffolding and formwork, having a flange on its shank to prevent it from being driven in all the way and to leave the head free for pulling. Also called form nail, scaffold nail.



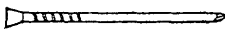
## concrete nail

A hardened-steel nail having a fluted or threaded shank and a diamond point for hammering into concrete or masonry. Also called masonry nail.



## flooring nail

A nail for fastening floor boards, having a small conical head, a mechanically deformed shank, and a blunt diamond point.



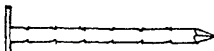
## ring-shank nail

A nail having a series of concentric grooves on its shank for increased holding power.



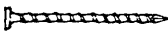
## roofing nail

A nail having a barbed, threaded, or cement-coated shank and a broad, flat head for fastening shingles or the like.



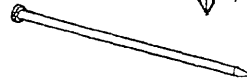
## drive screw

A metal fastener having a helically threaded shank that can be driven with a hammer and removed with a screw driver. Also called screw nail.



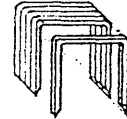
## spike

A heavy nail for fastening together heavy timbers, 4 to 14 in. (102 to 356 mm) long and proportionally thicker than a common nail.



## driftbolt

A spike having a round shank, driven into predrilled holes to fasten heavy timbers together. Also called drift pin.



## staple

A U-shaped piece of metal or heavy wire with pointed ends, driven into a surface to secure sheet material or to hold a hasp, pin, or bolt.

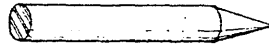


## corrugated fastener

A fastener consisting of a piece of corrugated sheet steel with one wavy edge sharpened, for uniting two pieces of wood, as in a miter joint. Also called wiggle nail.

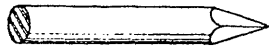
## round point

An acute, conical point on a nail or spike.



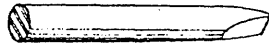
## diamond point

An acute, pyramidal point on a nail or spike.



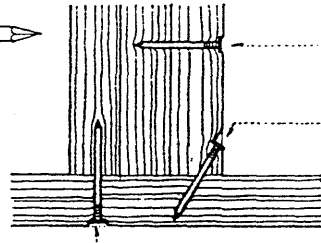
## chisel point

A point on a nail or spike formed by two flat inclined sides meeting at a sharp angle.



## face-nail

To fasten by nailing perpendicular to the face of the work.



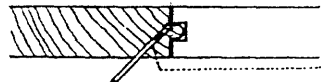
## toenail

To secure by nailing obliquely to the surfaces being joined. Alternate nails may be driven at opposite angles to provide increased holding power.



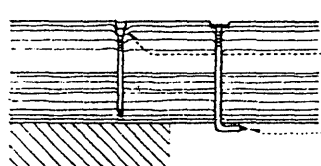
## end-nail

To fasten by nailing into the end of a board, parallel to the grain of the wood. End-nailing provides poor resistance to withdrawal.



## blind-nail

To secure by nailing in such a way that nailheads are not visible on the face of the work.



## set

To sink a nailhead slightly below the surface with a nail set.

## clinch

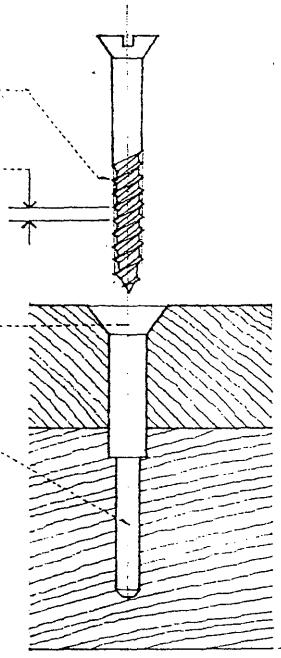
To secure a nail or screw in position by hammering down the protruding point.

## nailing strip

A strip of wood or other partly yielding material attached to a hard surface, as of steel or concrete, so that objects may be fastened to the surface.

**thread**  
The helical or spiral ridge of a screw, nut, or bolt.

**pitch**  
The distance between two corresponding points on adjacent threads of a screw, nut, or bolt.



**countersink**  
To enlarge the upper part of a drilled hole so that the head of screw or bolt will lie flush with or below the surface.

**pilot hole**  
A guiding hole for a nail or screw, or for drilling a larger-size hole.

**tap**  
To cut screw threads into an opening.

**strip**  
To tear or damage the threads on a bolt or screw by applying too much force.

**flat head**  
A screw head having a flat upper surface and a conical bearing surface.

**oval head**  
A screw head having a shallow, spherical shape with a conical bearing surface.

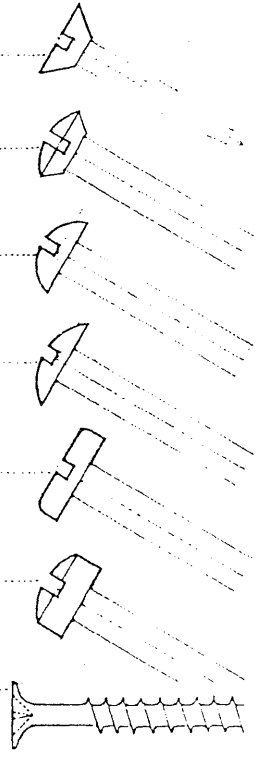
**round head**  
A screw or bolt head having a spherical shape with a flat bearing surface. Also called **buttonhead**.

**truss head**  
A screw or bolt head having a shallow, spherical shape with a flat bearing surface.

**panhead**  
A screw or rivet head having a cylindrical shape with a rounded shoulder.

**fillister head**  
A cylindrical screw head having a slightly domed upper surface and a flat bearing surface.

**bugle head**  
A screw head having a flat upper surface and an underside shaped like the bell of a bugle.



**screw**  
A metal fastener having a tapered, helically threaded shank and a slotted head, designed to be driven into wood or the like by turning, as with a screwdriver.

**wood screw**  
A screw having a slotted head and a threaded point that permits it to form its own mating threads when driven into wood with a screwdriver.

**self-tapping screw**  
A coarse-threaded screw designed to tap its corresponding female thread as it is driven. Also called **tapping screw**.

**lag screw**  
A heavy, coarse-threaded screw having a square or hexagonal head driven by a wrench, used in areas inaccessible to the placement of a nut or where an exceptionally long bolt would be needed to penetrate a joint fully. Also called **coach screw**, **lag bolt**.

**machine screw**  
A metal fastener used with a nut or driven into a tapped hole, having a straight, threaded shank and a slotted or Phillips head for turning with a screwdriver.

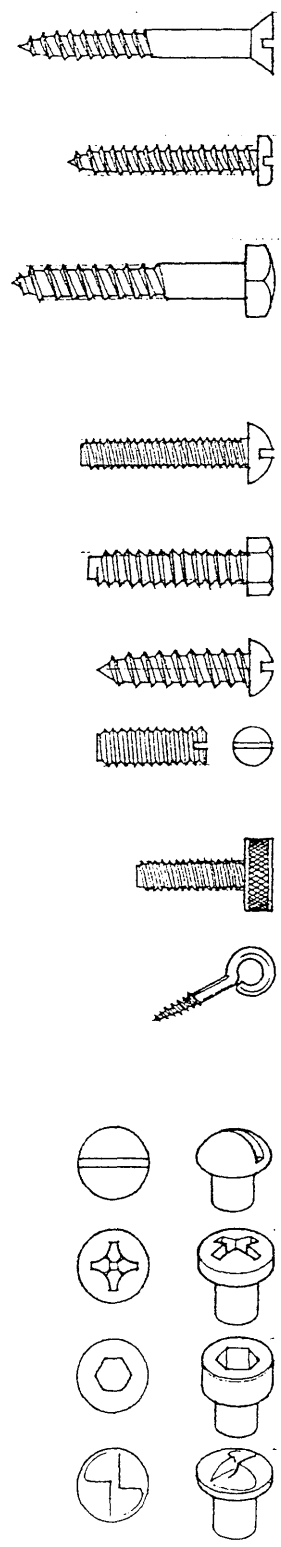
**cap screw**  
A metal fastener for machine parts, having a straight, threaded shank held by threads tapped in the hole into which it is screwed.

**sheet-metal screw**  
A coarse-threaded screw for fastening sheet metal and other thin material.

**setscrew**  
A screw, often without a head, threaded through a hole in one part tightly upon or into another part to prevent relative movement.

**thumbscrew**  
A screw having a flattened, knurled head designed to be turned by the thumb and forefinger.

**screw eye**  
A screw having a ring-shaped head.



**slotted head**  
A screw head having a single slot, driven by a flat-tipped screwdriver.

**Phillips head**  
A screw head having two partial slots crossing at right angles, driven by a Phillips screwdriver.

**Allen head**  
A screw head having an axial hexagonal recess, driven by an Allen wrench.

**security head**  
A screw head designed to resist removal with a flat-tipped or Phillips screwdriver.

# FASTENING

## bolt

A threaded metal pin or rod, usually having a head at one end, designed to be inserted through holes in assembled parts and secured by a mating nut.

## carriage bolt

A bolt having a rounded head, a flat bearing surface, and a square shoulder for preventing rotation, used where the head may be inaccessible during tightening.

## machine bolt

A bolt having a flat bearing surface and a square or hexagonal head for turning with a wrench.

## stove bolt

A small, coarse-threaded machine screw.

## J-bolt

A J-shaped metal rod threaded at one end to receive a nut.

## U-bolt

A metal rod bent in the shape of a U and threaded at each end.

## eyebolt

A bolt having a ring-shaped head to receive a hook or rope.

## clevis

A U-shaped fastener secured by a bolt or pin through holes in the end of the two arms.

## turnbuckle

A metal link or sleeve internally threaded at each end, used for coupling and tightening two parts, as the threaded ends of two rods or stays.

## expansion bolt

An anchor bolt having a split casing that expands mechanically to engage the sides of a hole drilled in masonry or concrete.

## Molly

Trademark for a brand of expansion bolt having a split, sleeve-like sheath threaded so that turning the bolt draws the ends of the sheath together and spreads the sides to engage a hole drilled in masonry or the inner surface of a hollow wall.

## expansion shield

A lead or plastic sleeve inserted into a predrilled hole and expanded by driving a bolt or screw into it. Also called expansion sleeve.

## toggle bolt

An anchor bolt having two hinged wings that close against a spring when passing through a predrilled hole and open as they emerge to engage the inner surface of a hollow wall.



## square head

A bolt or screw head having a square shape designed to be turned with a wrench.



## neck

The part on the shank of a bolt next to the head, esp. when it has a special form.



## hex head

A bolt or screw head having a hexagonal shape designed to be turned with a wrench.



## nut

A square or hexagonal metal block perforated with a threaded hole to fit around and secure a bolt or screw.



## lock nut

A nut specially constructed to provide extra friction between itself and a screw or bolt.



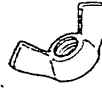
## castellated nut

A nut having radial slits on its outer face to allow a locking pin or wire to be inserted in both the nut and a hole in its bolt. Also called castle nut.



## cap nut

A nut having a hexagonal base and a domed top to cover the threaded end of a screw. Also called a con nut.



## wing nut

A nut having two flat projecting pieces that provide a grip for tightening with the thumb and forefinger. Also called thumbnut.



## washer

A perforated disk of metal, rubber, or plastic, used under the head of a nut or bolt or at a joint to distribute pressure, prevent leakage, or relieve friction.



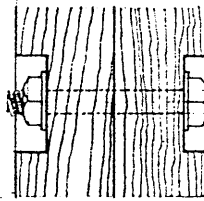
## lock washer

A washer specially constructed to prevent a nut from shaking loose.



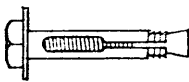
## load-indicating washer

A washer having small projections which are progressively flattened as a bolt is tightened, the gap between the head or nut and the washer indicating the tension in the bolt.



## counterbore

To increase the diameter of a portion of the length of a drilled hole to receive the head or nut of a bolt or screw.



## row spacing

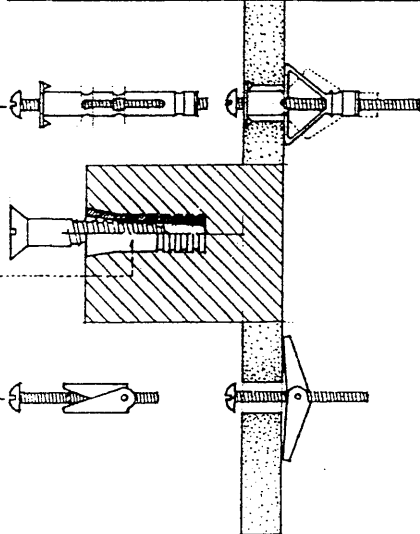
The center-to-center distance between two or more rows of bolts.

## end distance

The distance between the end of a timber and the center of the nearest bolt hole.

## edge distance

The distance from the edge of a timber and the center of the nearest bolt hole.



## Lewis bolt

An anchor bolt having a wedge-shaped end around which concrete or lead is poured to hold it.

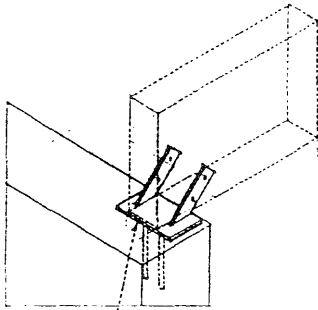


## fox bolt

An anchor bolt having a split end to receive a foxtail wedge as it is screwed into a blind hole.

**hanger**

Any of various U-shaped metal brackets for supporting the end of a beam, joist, purlin, or truss at a girder or wall. The supported member transfers its reaction to the hanger through bearing, but load transfer to the supporting member is through shear in the special nails securing the hanger.



**beam seat**

A U-shaped metal bracket for anchoring a timber beam to a concrete support.

**post cap**

A U-shaped metal bracket for securing a timber beam to a supporting post. Also called column cap.

**post base**

A U-shaped metal bracket for supporting and anchoring a timber post to its base or foundation. Also called column base.

**dowel**

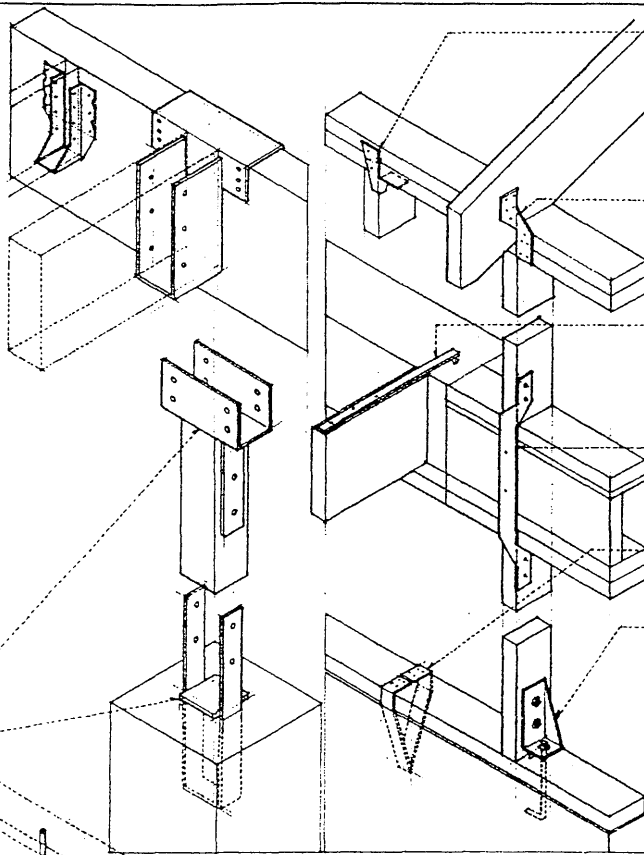
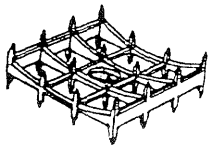
A cylindrical pin fitting snugly into holes in two adjacent pieces to prevent their slipping or to align them. Also called dowel pin.

**toothed plate**

A sheet-metal plate punched to produce a closely spaced grid of protruding teeth, used as a splice plate in the manufacture of light wood trusses.

**spike grid**

A flat or singly curved grid of spikes for joining heavy timbers, held in place by a single bolt. The resulting joint is resistant to loosening due to vibration, impact, and reversible lateral loads.



**framing anchor**

Any of various sheet-metal connectors for joining light wood framing members, using special nails which are loaded laterally rather than in withdrawal.

**hurricane anchor**

A framing anchor for tying a rafter or truss to a wall plate and securing it against lateral and uplifting wind and seismic forces. Also called hurricane tie.

**joist anchor**

A metal tie strap for securing the joists of a floor or roof diaphragm to a concrete or masonry wall in order to transmit lateral wind or seismic forces.

**floor anchor**

A metal tie strap for restraining a floor of a light wood frame structure against uplifting wind or seismic forces.

**sill anchor**

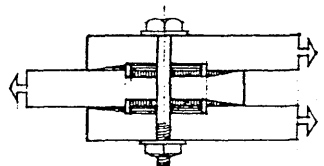
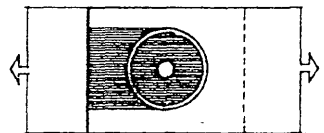
A framing anchor for securing a sill plate to a concrete slab or foundation wall.

**holddown**

A device for restraining a wood frame structure against uplifting wind or seismic forces, consisting of a stiffened steel angle bolted to a wall stud and secured by a threaded rod to a concrete foundation.

**timber connector**

A metal ring, plate, or grid for transferring shear between the faces of two timber members, used with a single bolt that serves to restrain and clamp the assembly together. Timber connectors are more efficient than bolts or lag screws used alone since they enlarge the area of wood over which a load is distributed.

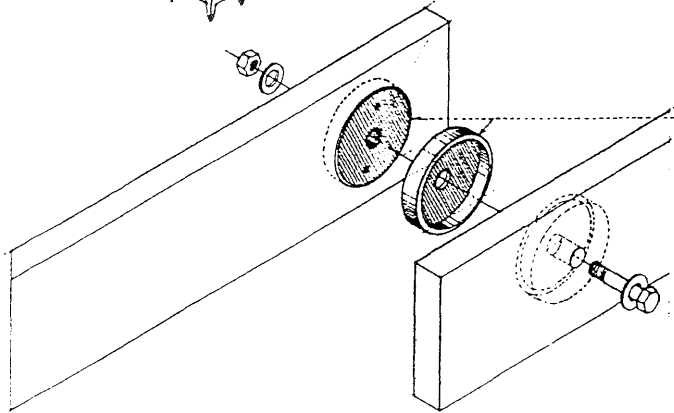


**shear plate**

A timber connector consisting of a round plate of malleable iron inserted into a corresponding groove, flush with the face of a timber, and held in place by a single bolt. Shear plates are used in back-to-back pairs to develop shear resistance in demountable wood-to-wood connections, or singly in a wood-to-metal connection.

**split-ring**

A timber connector consisting of a metal ring inserted into corresponding grooves cut into the faces of the joining members and held in place by a single bolt. The tongue-and-groove split in the ring permits it to deform slightly under loading and maintain bearing at all surfaces, while the beveled cross section eases insertion and ensures a tight-fitting joint after the ring is fully seated in the grooves.



# FASTENING

## solder

To unite two pieces of metal by applying any of various nonferrous solders, usually a tin-lead alloy, at a temperature below 800°F (427°C).

## solder

Any of various fusible alloys applied in a molten state to the joint between two metal parts to unite them without heating the parts to the melting point. The molten solder flows into a joint by capillary attraction.

## braze

To unite two pieces of metal by applying any of various nonferrous solders, usually a copper-zinc alloy, at a temperature above 800°F (427°C).

## filler metal

The metal that is added during a welding, brazing, or soldering process, having a melting point either approximately the same as or below that of the metals being welded.

## weld

To unite or fuse two pieces of metal by heating and allowing the metals to flow together, sometimes with pressure and the addition of an intermediate or filler metal.

## gas welding

Any of a group of welding processes utilizing the heat produced by the combustion of a oxygen and a fuel gas, as acetylene.

## arc welding

Any of a group of welding processes utilizing the heat of an arc between an electrode and the base metal.

## arc

A sustained luminous discharge of electricity across a gap in a circuit or between two electrodes. Also called electric arc.

## shielded metal arc welding

A method of arc welding using a consumable metal electrode that releases an inert gas to form a shield around the arc. This shield protects the weld area from oxygen and nitrogen in the air that would cause rapid oxidation of the liquid metal.

## inert-gas shielded arc welding

A method of arc welding in which the weld area is shielded by the continuous flow of an inert gas from an external source, the filler metal being supplied by a consumable metal electrode or by a separate welding rod.

## flux-cored arc welding

A method of arc welding using a tubular steel electrode containing a core of vaporizing flux that forms a gaseous shield around the weld area.

## submerged arc welding

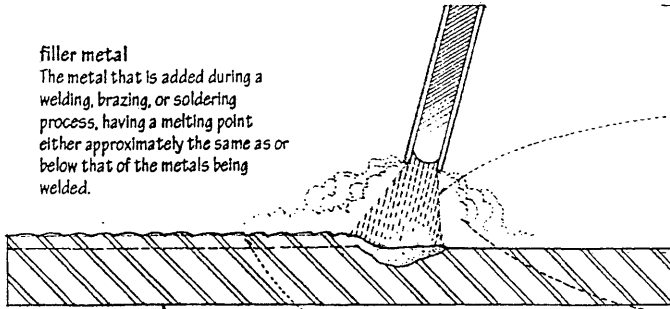
A method of arc welding in which the weld area is shielded by a blanket of fusible, granular metal that melts to form a layer of protective slag. The filler metal may be supplied by a consumable electrode or by a separate welding rod.

## resistance welding

Any of a group of welding processes utilizing the heat generated by resistance to the passage of a electric current.

## groove weld

A weld made in a preformed indentation between two abutting pieces of metal.



## base metal

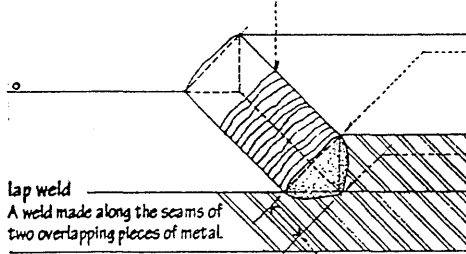
The principal metal to be welded, brazed, soldered, or cut, as distinguished from filler metal.

## bead

A continuous deposit of fused metal. Also called weld bead.

## fillet weld

A weld with a triangular cross section joining two surfaces that meet in an interior right angle.



## lap weld

A weld made along the seams of two overlapping pieces of metal.

## toe

The junction between the base metal and the face of a weld.

## root

The point at which the back or bottom of a weld meets the base metal.

## throat

The distance from the root of a weld to the face of the base metal.

## welding rod

A wire or rod of filler metal used in gas-welding and brazing processes, and in those arc-welding processes in which the electrode does not furnish the filler metal.

## flux

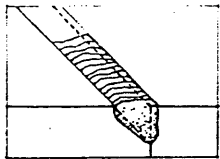
A substance, as rosin, applied to remove oxides from and prevent further oxidation of metal surfaces to be joined by welding, brazing, or soldering.

## butt weld

A weld between two pieces of metal butted together.

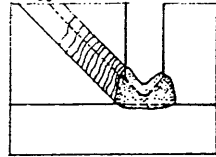
## partial-penetration weld

A butt weld having a depth less than the thickness of the smaller of the two members being joined.



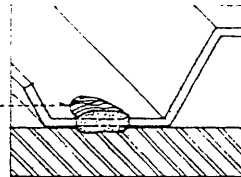
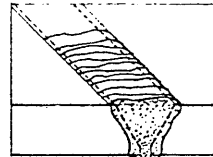
## full-penetration weld

A butt weld having a depth equal to the thickness of the smaller of the two members being joined.



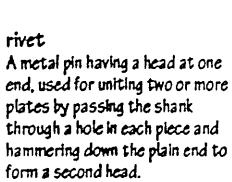
## puddle weld

A weld made by burning a hole in a piece of sheet metal and filling with a small pool of molten metal.



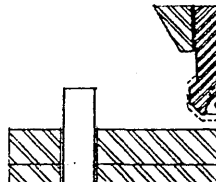
## single-bevel weld

A groove weld in which the edge of one abutting member is beveled from one side.



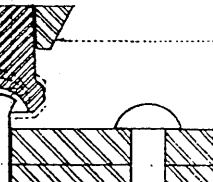
## double-bevel weld

A groove weld in which the edge of one abutting member is beveled from both sides.



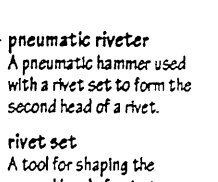
## single-vee weld

A groove weld in which the edge of each abutting member is beveled from the same side.



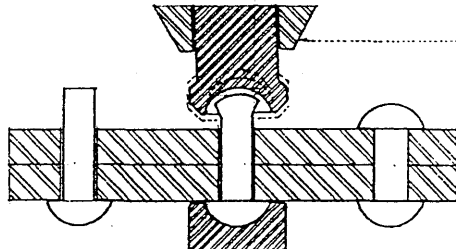
## double-vee weld

A groove weld in which the edge of each abutting member is beveled from both sides.



## rivet

A metal pin having a head at one end, used for uniting two or more plates by passing the shank through a hole in each piece and hammering down the plain end to form a second head.

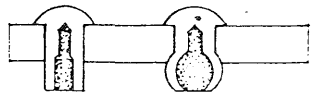


## pneumatic riveter

A pneumatic hammer used with a rivet set to form the second head of a rivet.

## rivet set

A tool for shaping the second head of a rivet.



## drift

A round, tapering piece of metal for enlarging or aligning holes to receive rivets or bolts. Also called driftpin.

## aligning punch

A drift for bringing holes in line to receive a rivet or bolt.

## dolly

A tool for receiving and holding the head of a rivet while the other end is being headed.

## explosive rivet

A rivet for a joint accessible from one side only, having an explosive-filled shank that is detonated by striking the head with a hammer to expand the shank on the far side of the hole.

**bonnet**  
A cover for an open fireplace, or a cowl, hood, or wind cap to increase the draft of a chimney.

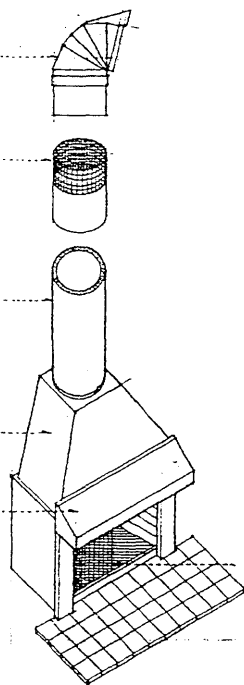
**cowl**  
A hoodlike covering for increasing the draft of a chimney or ventilator.

**spark arrester**  
A device, consisting of wire netting or the like, used to stop or deflect sparks or embers thrown from an open fireplace or chimney.

**prefabricated flue**  
A metal vent for fuel-fired equipment, assembled from factory-made parts.

**smoke dome**  
The smoke chamber covering of a prefabricated metal fireplace unit.

**hood**  
A metal cover or canopy for a stove, fireplace, chimney, or ventilator.



**chimney**  
A vertical, incombustible structure containing a flue through which the smoke and gases of a fire or furnace are carried off to the outside and by means of which a draft is created, esp. the part of such a structure that rises above a roof.

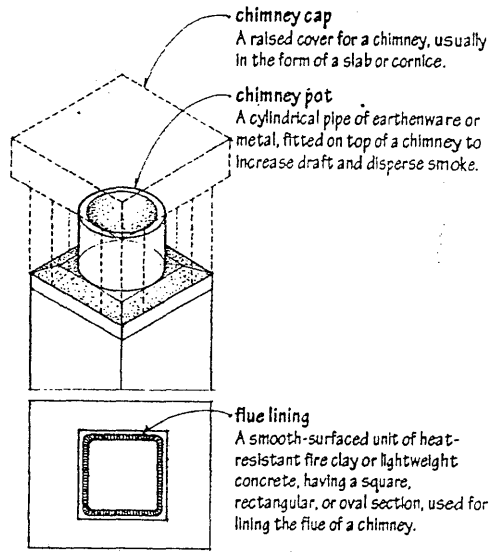
**smokestack**  
A pipe for the escape of the smoke or gases of combustion.

**draft**  
A current of air in any enclosed space, as in a room, chimney, or stove, caused by the difference in temperature or pressure.

**downdraft**  
A downward current of air in a chimney or flue, often carrying smoke with it.

**fire screen**  
A screen placed in front of a fireplace to prevent sparks or embers from entering the room.

A framed opening made in a chimney to hold an open fire.



**chimney cap**  
A raised cover for a chimney, usually in the form of a slab or cornice.

**chimney pot**  
A cylindrical pipe of earthenware or metal, fitted on top of a chimney to increase draft and disperse smoke.

**flue lining**  
A smooth-surfaced unit of heat-resistant fire clay or lightweight concrete, having a square, rectangular, or oval section, used for lining the flue of a chimney.

**flue**  
An incombustible passage or duct for smoke in a chimney.

**targeting**  
A smooth lining of mortar or plaster for a chimney flue. Also, parget.

**mantel**  
A construction framing the opening of a fireplace and usually covering part of the chimney breast in a decorative manner. Also called mantelpiece.

**manteltree**  
A stone or wooden lintel over a fireplace opening, or a masonry arch used in place of such a lintel.

**chimney breast**  
A part of a chimney or fireplace that projects out from a wall, usually inside a building.

**chimney arch**  
An arch over a fireplace opening, supporting the breast.

**chimney bar**  
A steel lintel for carrying the masonry above the fireplace opening. Also called camber bar, turning bar.

**chimney cheek**  
The sides of a fireplace opening supporting the mantel.

**hearth**  
The floor of a fireplace, usually of brick, tile, or stone, often extending a short distance into a room.

**back hearth**  
The part of the hearth that is contained within the fireplace itself. Also called inner hearth.

**front hearth**  
The part of the hearth that projects into the room. Also called outer hearth.

**draft**  
A device for regulating the current of air in a stove or fireplace.

**damper**  
A movable plate for regulating the draft in a fireplace, stove, or furnace.

**smoke chamber**  
An enlarged area between the throat of a fireplace and the flue of a chimney.

**smoke shelf**  
A ledge at the bottom of a smoke chamber, so made as to deflect or break the downdrafts from the chimney.

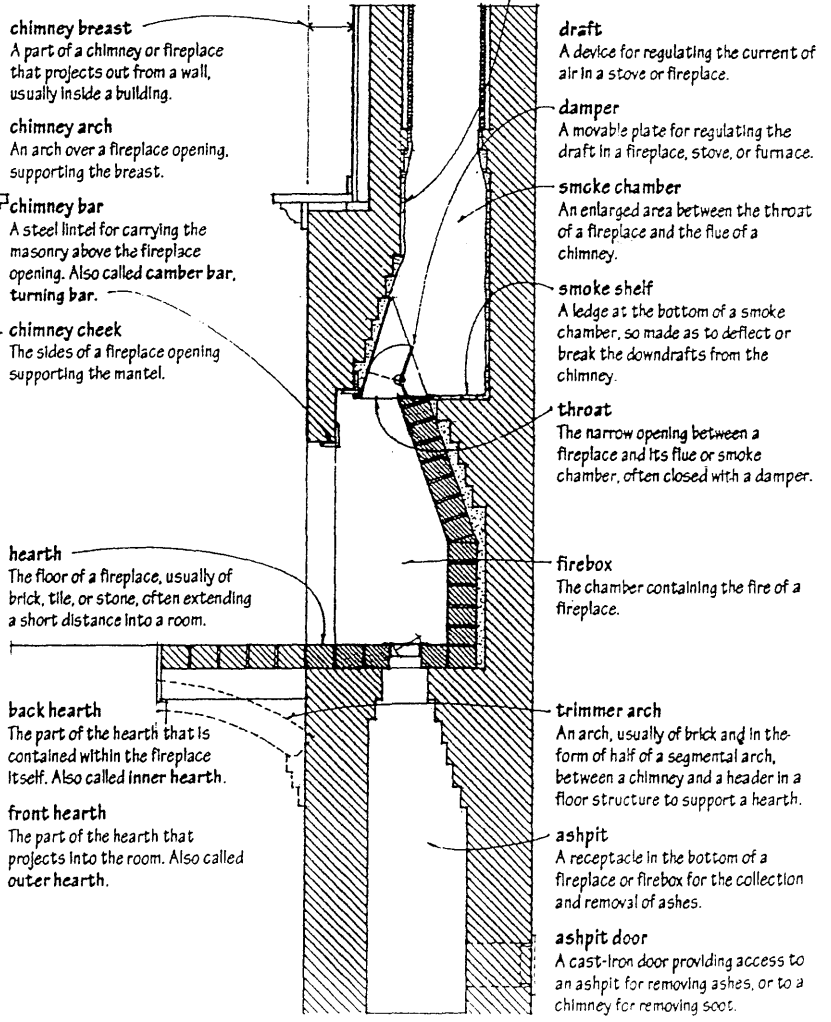
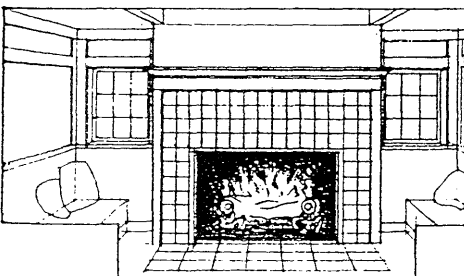
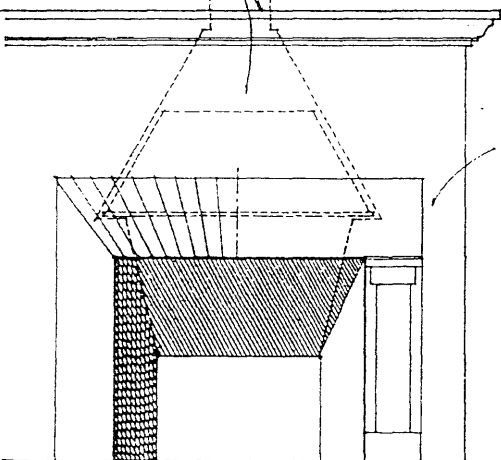
**throat**  
The narrow opening between a fireplace and its flue or smoke chamber, often closed with a damper.

**firebox**  
The chamber containing the fire of a fireplace.

**trimmer arch**  
An arch, usually of brick and in the form of half of a segmental arch, between a chimney and a header in a floor structure to support a hearth.

**ashpit**  
A receptacle in the bottom of a fireplace or firebox for the collection and removal of ashes.

**ashpit door**  
A cast-iron door providing access to an ashpit for removing ashes, or to a chimney for removing soot.



**inglenook**  
A corner or nook near a large, open fireplace, usually provided with seating. Also called chimney corner.

# FIRE SAFETY

The measures taken to prevent fire or minimize the loss of life or property resulting from a fire, including limiting fire loads and hazards, confining the spread of fire with fire-resistant construction, the use of fire detection and extinguishing systems, the establishment of adequate firefighting services, and the training of building occupants in fire safety and evacuation procedures.

## fire hazard

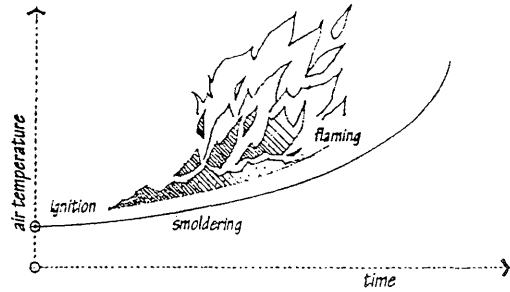
Any condition that increases the likelihood of a fire, obstructs access to firefighting equipment, or delays the egress of occupants in the event of fire.

## fire load

The amount of combustible material in a building, measured in pounds per square foot of floor area.

## combustible

Of or pertaining to a material capable of igniting and burning.

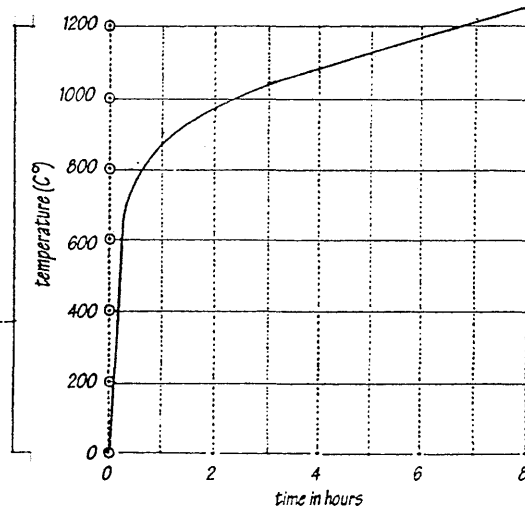


## fire-rated

Noting or pertaining to a material, assembly, or construction having a fire-resistance rating required by its use. Also, fire-resistive.

## fire-resistance rating

The time in hours a material or assembly can be expected to withstand exposure to fire without collapsing, developing any openings which permit the passage of flame or hot gases, or exceeding a specified temperature on the side away from the fire, determined by subjecting a full-size specimen to temperatures according to a standard time-temperature curve.



## ignition point

The lowest temperature at which a substance will undergo spontaneous combustion and continue to burn without additional application of external heat.

## flash point

The lowest temperature at which a combustible liquid will give off sufficient vapor to ignite momentarily when exposed to flame.

## tunnel test

A test measuring the time it takes for a controlled flame to spread across the face of a test specimen, the amount of fuel the material contributes to the fire, and the density of the smoke developed by the fire. Also called Steiner tunnel test.

## flame-spread rating

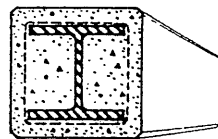
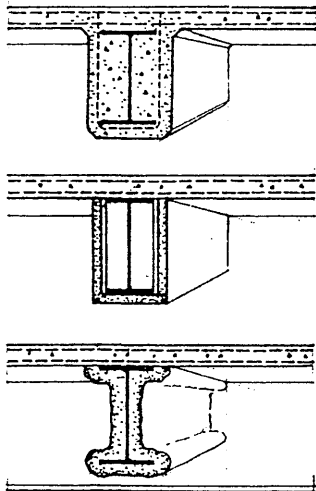
A rating of how quickly a fire can spread along the surface of an interior finish material. Red oak flooring has a flame-spread rating of 100 while a cement-asbestos board has a rating of 0.

## fuel-contribution rating

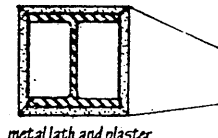
A rating of the amount of combustible substances an interior finish material can contribute to a fire.

## smoke-developed rating

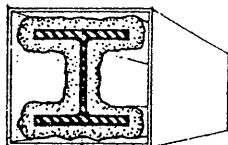
A rating of the amount of smoke an interior finish material can produce when it burns. Materials having a smoke-developed rating above 450 are not permitted to be used inside buildings.



concrete



metal lath and plaster



## spray-on fireproofing

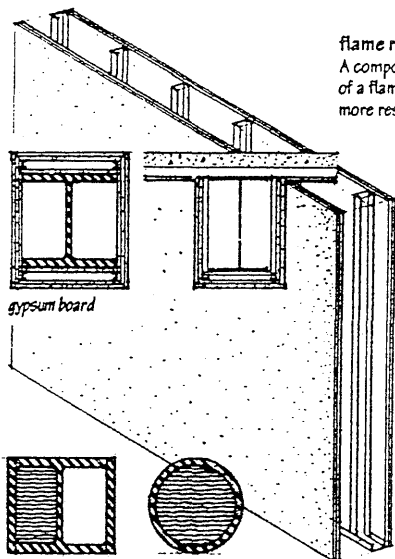
A mixture of mineral fibers and an inorganic binder, applied by air pressure with a spray gun to provide a thermal barrier to the heat of a fire.

## fireproofing

Any of various materials, as concrete, gypsum, or mineral fiber, used in making a structural member or system resistant to damage or destruction by fire.

## intumescent paint

A coating that, when exposed to the heat of a fire, swells to form a thick insulating layer of inert gas bubbles that retards flame spread and combustion.



gypsum board



## liquid-filled column

A hollow structural-steel column filled with water to increase its fire resistance. If exposed to flame, the water absorbs heat, rises by convection to remove the heat, and is replaced with cooler water from a storage tank or a city water main.

## flame retardant

A compound used to raise the ignition point of a flammable material, thus making it more resistant to fire.



**fire zone**  
A zone of a city within which certain construction types are prohibited because of fire hazards present in the zone.

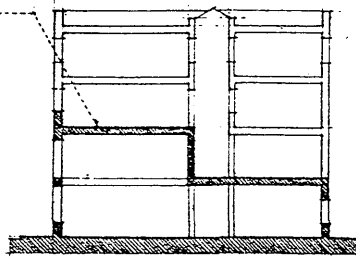
**firebreak**  
An open space established to prevent the spread of fire from a building, a group of buildings, or an area of a city to another.

**fire separation**  
Any floor, wall, or roof-ceiling construction having the required fire-resistance rating to confine the spread of fire.

**occupancy separation**  
A vertical or horizontal construction having the required fire-resistance rating to prevent the spread of fire from one occupancy to another in a mixed-occupancy building.

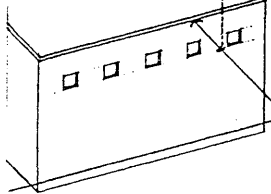
**distance separation**  
The separation required between an exterior wall of a building and a property line, the center line of an adjacent street or public space, or the exterior wall of an adjacent building, all measured at right angles to the exterior wall.

**fire area**  
An area of a building enclosed by fire-rated construction capable of confining the spread of fire.



**fire wall**  
A wall having the required fire-resistance rating to prevent the spread of fire from one part of a building to another, extending from the foundation to a parapet above the roof and having all openings restricted to a certain percentage of the wall length and protected by a self-closing or automatic-closing fire assembly. Each portion of a building separated by one or more fire walls may be considered a separate building when calculating the floor area and height allowed by a building code.

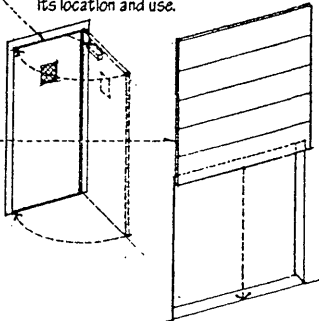
**draft stop**  
A fire-rated partition dividing an enclosed attic space of combustible construction, or the concealed space between a suspended ceiling and a wood-frame floor above.



**fire assembly**  
The assembly of a fire door, fire window, or fire damper, including all required hardware, anchorage, frames, and sills.

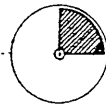
**protected opening**  
An opening in a wall, floor, or roof-ceiling construction that is fitted with a fire assembly having the required fire-resistance rating for its location and use.

**self-closing fire assembly**  
A fire assembly that is normally kept in a closed position and is equipped with an approved device to insure closing and latching after having been opened for use.



**automatic-closing fire assembly**  
A fire assembly that may remain in an open position and will close automatically if subjected to an increase in temperature or actuated by a smoke detector.

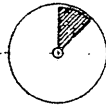
**class A**  
Classification for a fire assembly having a 3-hour fire-resistance rating for protecting openings in 3-hour or 4-hour fire walls and occupancy separations.



**UL label**  
A label affixed to a building material, component, or device with the authorization of Underwriters' Laboratories, Inc., indicating that the product (a) has a rating based on performance tests of such products; (b) is from a production lot found by examination to be made from materials and by processes essentially identical to those of representative products which have been subjected to appropriate fire, electrical hazard, or other tests for safety; and (c) is subject to the reexamination service of UL.

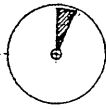


**class B**  
Classification for a fire assembly having a 1-hour or 1 1/2-hour fire-resistance rating for protecting openings in 1-hour or 2-hour fire separations, exit stairways, and vertical shafts.

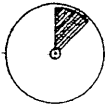


**labeled**  
Of or pertaining to a building material or assembly having a fire-resistance rating certified by Underwriters' Laboratories, Inc. or other recognized testing laboratory.

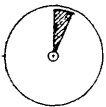
**class C**  
Classification for a fire assembly having a 3/4-hour fire-resistance rating for protecting openings in 1-hour walls, corridors, and hazardous areas.



**class D**  
Classification for a fire assembly having a 1 1/2-hour fire-resistance rating for protecting openings in exterior walls subject to severe fire exposure from outside the building.



**class E**  
Classification for a fire assembly having a 3/4-hour fire-resistance rating for protecting openings in exterior walls subject to light or moderate fire exposure from outside the building.



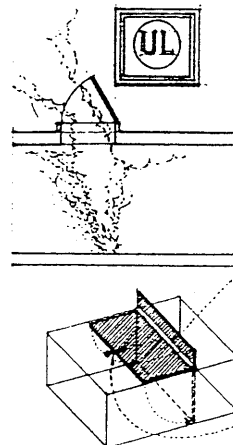
**fire door**  
A door assembly, including all required hardware, anchorage, frames and sills, having the required fire-resistance rating for its location and use.

**fire window**  
A window assembly, including all required hardware, anchorage, frames and sills, having the required fire-resistance rating for its location and use.

**smoke vent**  
A vent designed to open automatically in the event of fire in order to remove smoke and heat from a building.

**fire damper**  
A damper that closes an air duct automatically in the event of fire to restrict the passage of fire and smoke, required where a duct penetrates a fire wall, fire-rated shaft, or other fire separation.

**fusible link**  
A link made of a fusible metal. When exposed to the heat of a fire, the link melts and causes a fire door, fire damper, or the like to close.



# FIRE SAFETY

## fire-alarm system

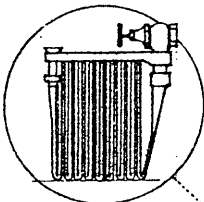
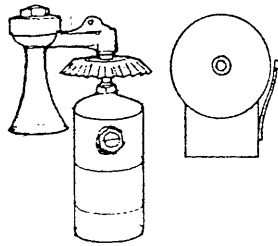
An electrical system installed in a building to automatically sound an alarm when actuated by a fire-detection system.

## fire-detection system

A system of thermostats or other approved sensors for detecting the presence of fire and automatically signaling an alarm.

## smoke detector

An electronic fire alarm that is activated by the presence of smoke.



## standpipe

A water pipe extending vertically through a building to supply fire hoses at every floor.

## wet standpipe

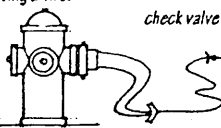
A standpipe containing water under pressure and fitted with fire hoses for emergency use by building occupants.

## dry standpipe

A standpipe containing no water and used by the fire department to connect fire hoses to a fire hydrant or pumper truck.

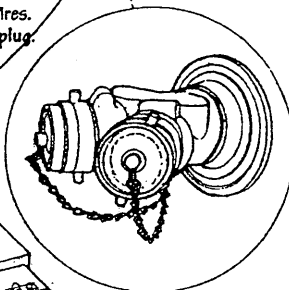
## fire hose

A heavy-duty hose for use in fighting a fire.



## hydrant

An upright pipe with one or more nozzles or spouts for drawing water from a main, esp. for fighting fires. Also called fire hydrant, fireplug.

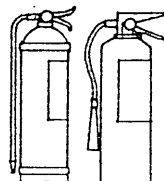


pumper truck

## siamese

A pipe fitting installed close to the ground on the exterior of a building, providing two or more connections through which the fire department can pump water to a standpipe or sprinkler system.

water main



## fire extinguisher

A portable apparatus for putting out a small fire by ejecting pressurized water or special chemicals, classified according to the type of fire it is able to extinguish.

## sprinkler system

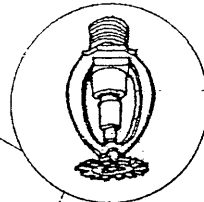
Apparatus for automatically extinguishing fires in a building, consisting of a system of pipes in or below the ceilings, connected to a suitable water supply, and supplied with valves or sprinkler heads made to open automatically at a certain temperature.

## sprinklered

Of or pertaining to a building or building area that has or is protected by a properly maintained sprinkler system.

## sprinkler head

A nozzle in a sprinkler system for dispersing a stream or spray of water, usually controlled by a fusible link that melts at a predetermined temperature.



## automatic fire-extinguishing system

A system of devices and equipment which automatically detects a fire and discharges an approved fire-extinguishing agent onto or in the area of a fire.

## wet-pipe system

A sprinkler system containing water at sufficient pressure to provide an immediate, continuous discharge through sprinkler heads that open automatically in the event of fire.

## dry-pipe system

A sprinkler system containing pressurized air that is released when a sprinkler head opens in the event of fire, allowing water to flow through the piping and out the opened nozzle. Dry-pipe systems are used where the piping is subject to freezing.

## preaction system

A dry-pipe sprinkler system through which water flow is controlled by a valve operated by fire-detection devices more sensitive than those in the sprinkler heads. Preaction systems are used when an accidental discharge would damage valuable materials.

## deluge system

A sprinkler system having sprinkler heads open at all times, through which water flow is controlled by a valve operated by a heat-, smoke-, or flame-sensing device.

## class A fire

A fire involving ordinary combustible materials, as wood, paper and cloth, on which the quenching or cooling effect of water is of primary importance.

## class B fire

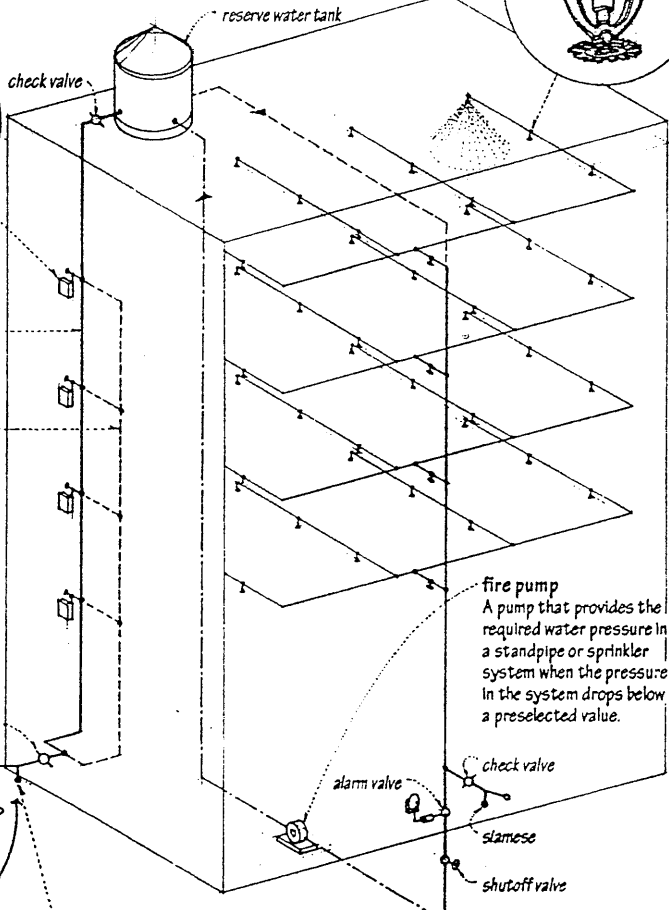
A fire involving flammable liquids, as gasoline, oil and grease, which must be extinguished by excluding air and inhibiting the release of combustible vapors.

## class C fire

A fire involving live electrical equipment, which requires a nonconducting extinguishing medium.

## class D fire

A fire involving certain combustible metals, as magnesium or sodium, which requires a nonreactive, heat-absorbing extinguishing medium.



**exit access**

That portion of a means of egress that leads to an exit. Building codes specify the maximum distance of travel to an exit and the minimum distance between exits when two or more are required.

**horizontal exit**

A passage through or around a wall constructed as required for an occupancy separation, protected by an automatic-closing fire door, and leading to an area of refuge in the same building or on approximately the same level in an adjacent building.

**means of egress**

A continuous path of travel from any point in a building to the outside at ground level.

**exit**

An enclosed and protected path of escape for the occupants of a building in the event of fire, leading from an exit access to an exit discharge.

**area of refuge**

An area affording safety from fire or smoke coming from the area from which escape is made.

**smokeproof enclosure**

The enclosing of an exit stairway by walls of fire-resistive construction, accessible by a vestibule or by an open exterior balcony, and ventilated by natural or mechanical means to limit the penetration of smoke and heat. Building codes usually require one or more of the exit stairways for a high-rise building be protected by a smokeproof enclosure.

**exit stairway**

A stairway leading to an exit passageway, an exit court, or public way, enclosed by fire-resistive construction with self-closing fire doors that swing in the direction of exit travel.

**exterior exit balcony**

A landing or porch projecting from the wall of a building and serving as a required means of egress.

**fire escape**

An exit stairway down an outside wall of a building, constructed to the same standards as an interior exit stairway.

**exterior exit**

An exit door opening directly to an exit court or public way.

**exit discharge**

That portion of a means of egress that leads from an exit to an exit court or public way.

**exit court**

A yard or court providing egress to a public way for one or more required exits.

**public way**

A street, alley, or similar parcel of land open to the sky and deeded, dedicated, or otherwise permanently appropriated for the free passage and use of the general public.

**well**

A shaft for air, light, stairs, or an elevator, extending vertically through the floors of a building.

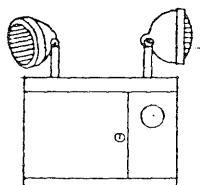


**exit light**

An illuminated sign identifying a required exit.

**emergency lighting**

A lighting system designed to supply the illumination required for safe egress from a building in the event of a power failure.



**exit corridor**

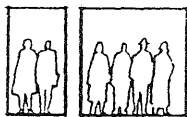
A passageway serving as a required exit, enclosed by walls of fire-resistive construction. Building codes limit the length of dead-end corridors.

**exit door**

A door providing access to a means of egress, swinging in the direction of exit travel, and usually equipped with a panic bar.

**exit passageway**

A means of egress connecting a required exit or exit court with a public way, having no openings other than required exits and enclosed by fire-resistive construction as required for the walls, floors, and ceiling of the building served.

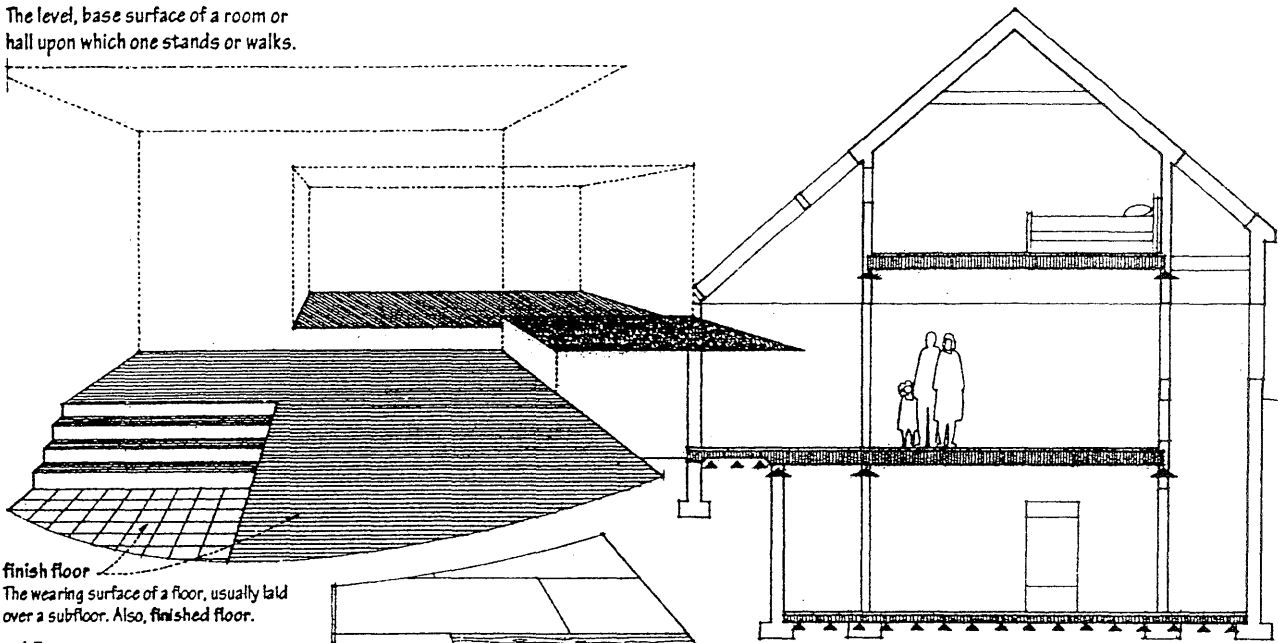


**occupant load**

The total number of persons that may occupy a building or portion thereof at any one time, determined by dividing the floor area assigned to a particular use by the square feet per occupant permitted in that use. Building codes use occupant load to establish the required number and width of exits for a building.

# FLOOR

The level, base surface of a room or hall upon which one stands or walks.



**finish floor**  
The wearing surface of a floor, usually laid over a subfloor. Also, finished floor.

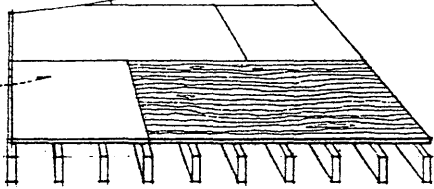
**subfloor**  
A base for a finish floor, consisting of boards, plywood, or other structural sheathing laid over and fixed to the floor joists. A subfloor is often used as a working platform during construction and may also act as a structural diaphragm to transfer lateral loads to shear walls. Also called blind floor, rough floor.

**floor framing**  
The act, process, or manner of constructing the structural frame of a floor.

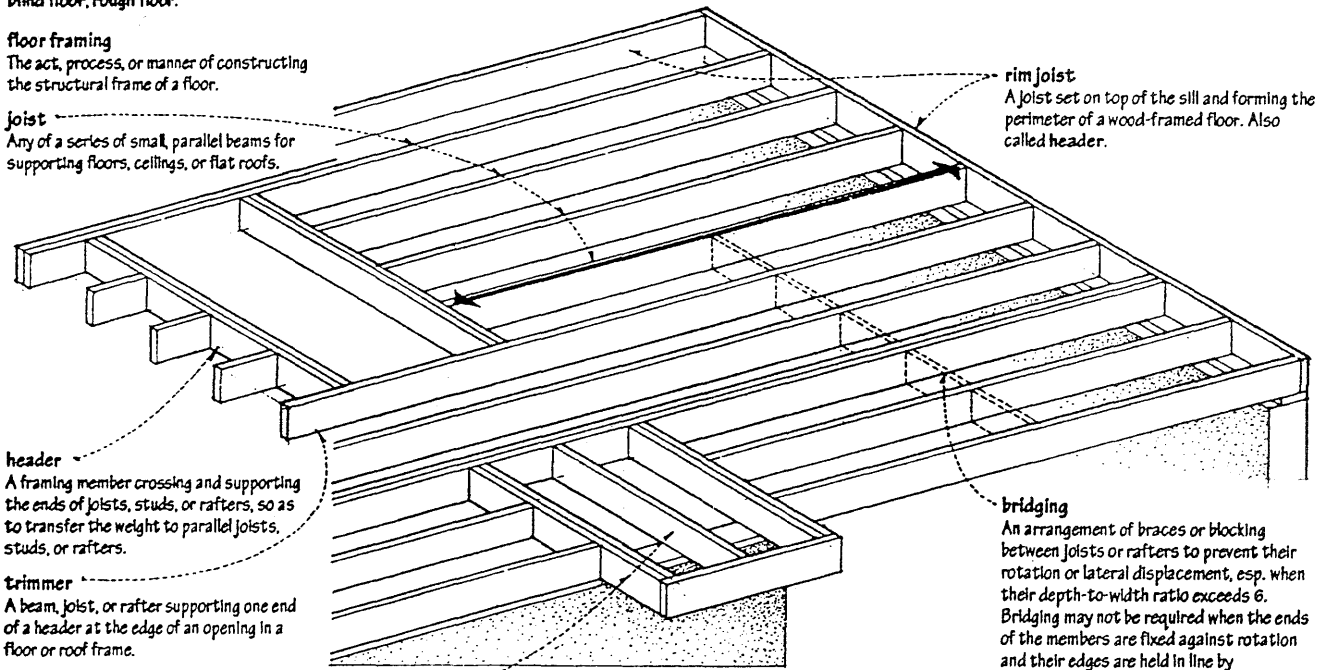
**joist**  
Any of a series of small, parallel beams for supporting floors, ceilings, or flat roofs.

**header**  
A framing member crossing and supporting the ends of joists, studs, or rafters, so as to transfer the weight to parallel joists, studs, or rafters.

**trimmer**  
A beam, joist, or rafter supporting one end of a header at the edge of an opening in a floor or roof frame.

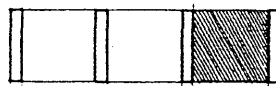


**rim joist**  
A joist set on top of the sill and forming the perimeter of a wood-framed floor. Also called header.

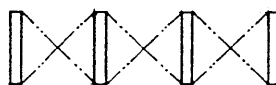


**tailpiece**  
A relatively short beam, joist, or rafter supported by a wall at one end and by a header at the other. Also called stringer.

**bridging**  
An arrangement of braces or blocking between joists or rafters to prevent their rotation or lateral displacement, esp. when their depth-to-width ratio exceeds 6. Bridging may not be required when the ends of the members are fixed against rotation and their edges are held in line by subflooring or sheathing.



**solid bridging**  
Bridging consisting of short boards fixed vertically between floor or roof joists.



**crossbridging**  
Bridging composed of diagonal braces set in pairs between floor or roof joists.

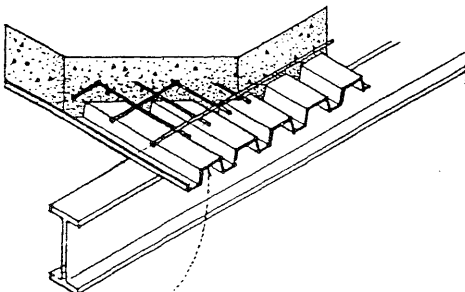
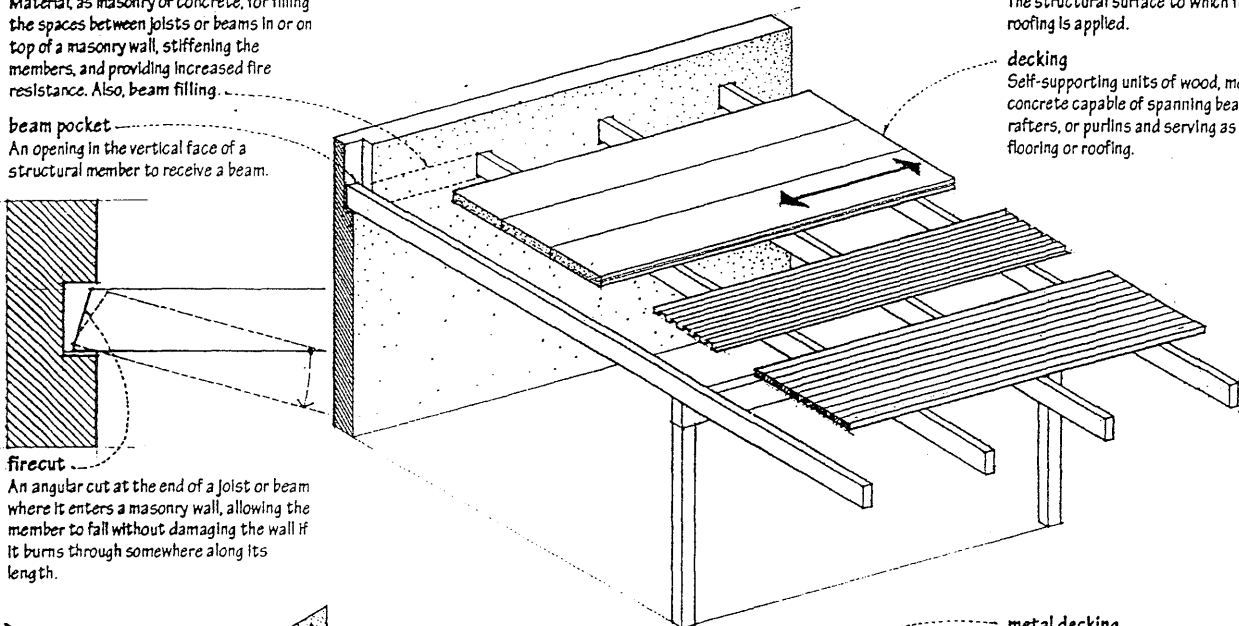
**beam fill**  
Material, as masonry or concrete, for filling the spaces between joists or beams in or on top of a masonry wall, stiffening the members, and providing increased fire resistance. Also, beam filling.

**beam pocket**  
An opening in the vertical face of a structural member to receive a beam.

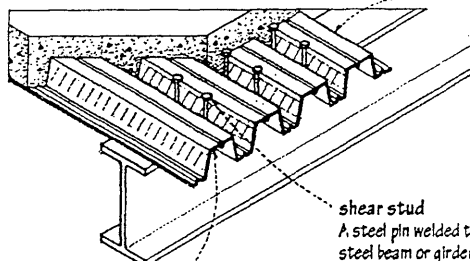
**firecut**  
An angular cut at the end of a joist or beam where it enters a masonry wall, allowing the member to fall without damaging the wall if it burns through somewhere along its length.

**deck**  
The structural surface to which flooring or roofing is applied.

**decking**  
Self-supporting units of wood, metal, or concrete capable of spanning beams, joists, rafters, or purlins and serving as a base for flooring or roofing.



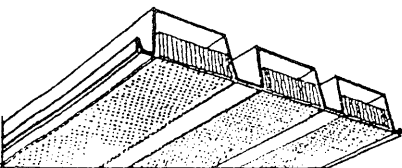
**form decking**  
Metal decking serving as permanent formwork for a reinforced concrete slab until the slab can support itself.



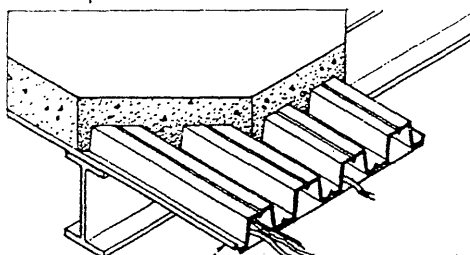
**composite decking**  
Metal decking serving as permanent formwork and tensile reinforcement for a concrete slab bonded to it by a deformed or dovetail rib pattern.

**metal decking**  
Sheet steel strengthened for use as floor or roof decking by cold-rolling a series of ribs or flutes into it, and usually galvanized for corrosion resistance. The spanning capability of metal decking depends on the thickness of the steel sheet and the depth of the corrugations.

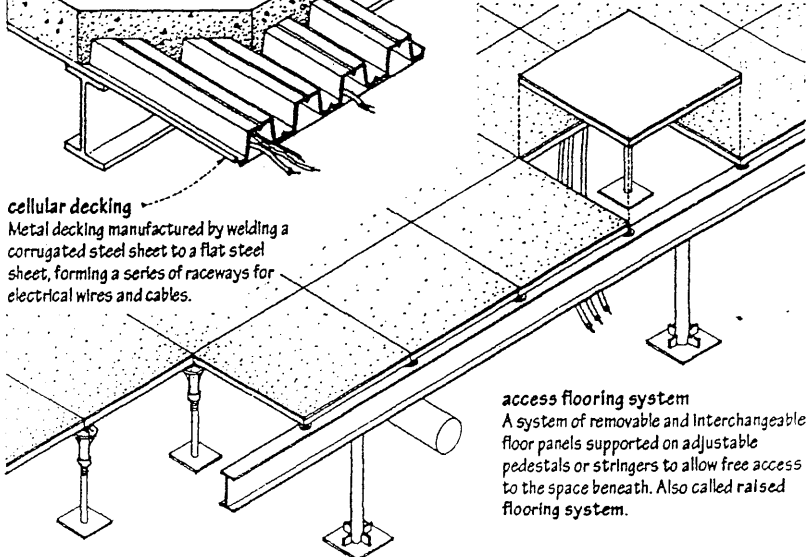
**shear stud**  
A steel pin welded to the top flange of a steel beam or girder and embedded in a concrete slab so as to cause the beam and the concrete to act as a structural unit.



**acoustic decking**  
Metal decking containing glass fiber between the perforated webs of ribbed decking or in the perforated cells of cellular decking, used as a sound-absorbing ceiling.



**cellular decking**  
Metal decking manufactured by welding a corrugated steel sheet to a flat steel sheet, forming a series of raceways for electrical wires and cables.



**access flooring system**  
A system of removable and interchangeable floor panels supported on adjustable pedestals or stringers to allow free access to the space beneath. Also called raised flooring system.

# FLOOR

## finish flooring

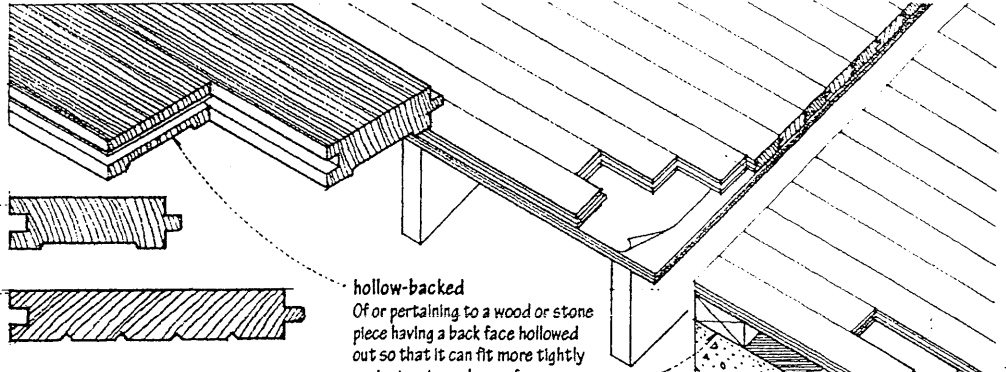
Material used for the wearing surface of a floor, as hardwood, terrazzo, or floor tile.

## wood flooring

Finish flooring in the form of wood strips, planks, or blocks.

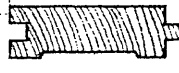
## strip flooring

Flooring composed of long, narrow wood strips, usually side- and end-matched.



## plank flooring

Flooring composed of boards wider than strip flooring, usually side- and end-matched.



## hollow-backed

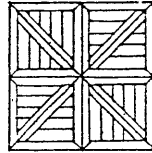
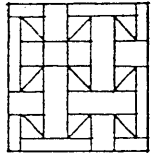
Of or pertaining to a wood or stone piece having a back face hollowed out so that it can fit more tightly against an irregular surface.

## sleeper

Any of a number of wooden strips laid upon a concrete slab to provide a means of attaching a subfloor or flooring.

## solid block flooring

Long-wearing flooring composed of solid wood blocks set in adhesive with their grain oriented vertically.

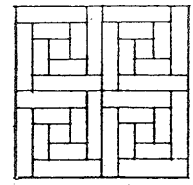
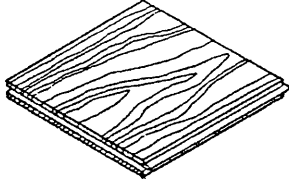
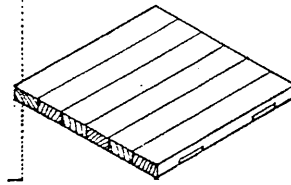
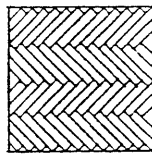
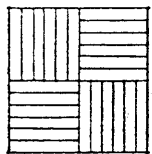
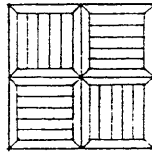
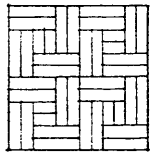


## parquet

A floor composed of short strips or blocks of wood forming a pattern, sometimes with inlays of other woods or other materials.

## parquetry

Mosaic work of wood used for floors and wainscoting.



## block flooring

Flooring composed of square units preassembled at the mill and usually installed with mastic over a wood subfloor or concrete slab.

## unit block

A flooring block made by joining short lengths of strip flooring edgewise, usually tongued on two adjoining sides and grooved on the other two to ensure proper alignment in setting.

## laminated block

A flooring block made by bonding three or more wood veneers with a moisture-resistant adhesive, usually tongued on two opposing sides and grooved on the other two to ensure proper alignment in setting.

## slat block

A flooring block made by assembling narrow slats or fingers of hardwood into larger units.

## terrazzo

A mosaic floor or paving composed of marble or other stone chips, set in a cementitious or resinous matrix and ground when dry.



## standard terrazzo

A ground and polished terrazzo finish consisting mainly of relatively small stone chips.

## Venetian terrazzo

A ground and polished terrazzo finish consisting mainly of large stone chips, with smaller chips filling the spaces between.



## rustic terrazzo

A uniformly textured terrazzo finish produced by washing the matrix prior to setting so as to expose the chips, which are not ground.

## Palladiana

A mosaic terrazzo finish consisting of cut or fractured marble slabs set by hand in the desired pattern, with smaller chips filling the spaces between.

## topping

The mixture of stone chips and cementitious or resinous matrix that produces a terrazzo surface.

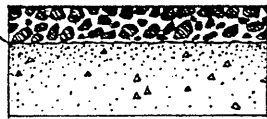


## thin-set terrazzo

A thin resinous terrazzo topping directly over a sound wood, metal, or concrete subfloor.

## bonding agent

A chemical substance applied to a substrate to create a bond between it and a succeeding layer, as between a terrazzo topping and a subfloor.

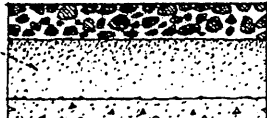


## monolithic terrazzo

A terrazzo topping installed directly over a rough-finished concrete slab. A chemical bonding agent is used if the concrete surface is too smooth for a mechanical bond.

## underbed

The mortar base on which a terrazzo topping is applied.

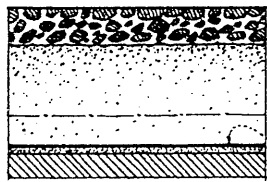


## bonded terrazzo

A terrazzo topping installed over a mortar underbed that is bonded to a rough-finished concrete slab.

## resinous matrix

A latex, polyester, or epoxy binder combined with stone chips to form a terrazzo topping especially resistant to chemicals and abrasion.



## sand-cushion terrazzo

A terrazzo system for controlling cracking when structural movement is expected, consisting of a terrazzo topping installed over a reinforced mortar underbed that is separated from the subfloor by an isolation membrane and a thin layer of sand.

**linoleum**  
A resilient floor covering formed by coating burlap or canvas with heated linseed oil, powdered cork, and rosin, and adding pigments to achieve the desired colors and patterns. Linoleum should be used only on a subfloor suspended above grade.

**vinyl sheet**  
A resilient floor covering composed principally of polyvinyl chloride in combination with mineral fillers, pigments, and a fiber, felt, or foam backing.

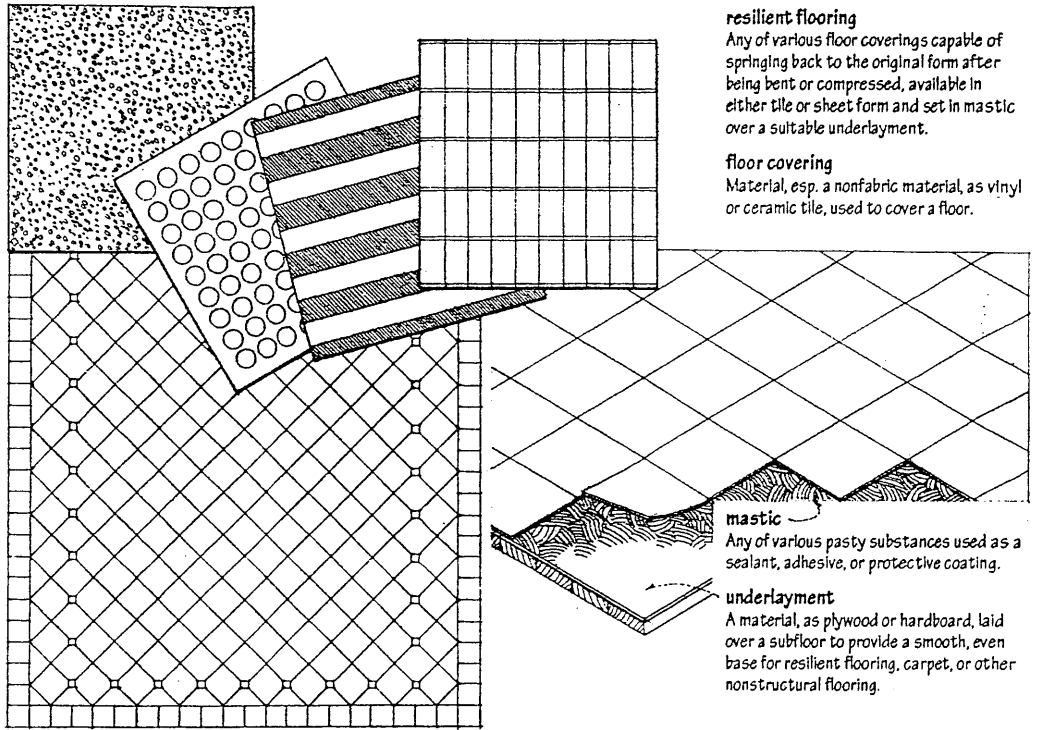
**vinyl tile**  
A resilient floor tile composed principally of polyvinyl chloride in combination with mineral fillers and pigments.

**cork tile**  
A resilient floor tile composed of granulated cork and synthetic resin binders, finished with a protective coat of wax or a film of clear polyvinyl chloride. Cork tile should be used only on a subfloor suspended above grade.

**rubber tile**  
A resilient floor tile composed of natural or synthetic rubber with mineral fillers.

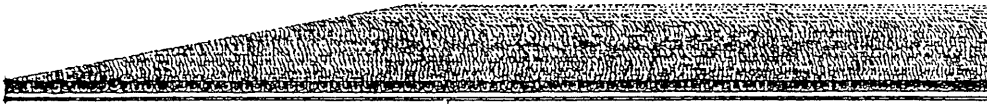
**resilient flooring**  
Any of various floor coverings capable of springing back to the original form after being bent or compressed, available in either tile or sheet form and set in mastic over a suitable underlayment.

**floor covering**  
Material, esp. a nonfabric material, as vinyl or ceramic tile, used to cover a floor.



**mastic**  
Any of various pasty substances used as a sealant, adhesive, or protective coating.

**underlayment**  
A material, as plywood or hardboard, laid over a subfloor to provide a smooth, even base for resilient flooring, carpet, or other nonstructural flooring.

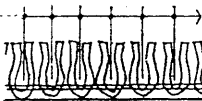


**carpet**  
A heavy woven, knitted, needle-tufted, or felted fabric for covering a floor.

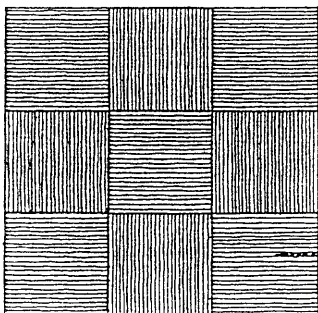
**pile weight**  
The average weight of pile yarn in a carpet, stated in ounces per square yard.

**pile density**  
The weight of pile yarn per unit volume of carpet, stated in ounces per cubic yard.

**pitch**  
The crosswise number of tuft-forming pile yarns in a 27-inch (686 mm) width of woven carpet.



**gauge**  
The spacing of tufts across the width of a tufted or knitted carpet, expressed in fractions of an inch.



**woven carpet**  
Carpet made by simultaneously interweaving the backing and pile yarns on a loom.

**tufted carpet**  
Carpet made by mechanically stitching pile yarn through a primary fabric backing and bonded with latex to a secondary backing.

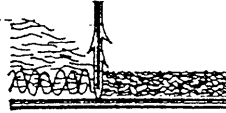
**knitted carpet**  
Carpet made by looping the backing, stitching, and pile yarns with three sets of needles.

**fusion-bonded carpet**  
Carpet made by heat-fusing face yarns to a vinyl backing supported by other materials.

**flocked carpet**  
Carpet made by propelling short strands of pile fiber electrostatically against an adhesive-coated backing.

**needlepunched carpet**  
Carpet made by punching carpet fibers back and forth through a woven polypropylene sheet with barbed needles to form a felted fiber mat.

**carpet tile**  
A flooring tile made of carpeting material.



**pile**  
The upright tufts of yarn forming the surface of a carpet or fabric.

**loop pile**  
A carpet texture created by weaving, tufting, or knitting the pile yarn into loops.

**cut pile**  
A carpet texture created by cutting each loop of pile yarn, producing a range of textures from informal shags to short, dense velvets.

**backing**  
The foundation material securing the pile yarns of a carpet and providing it with stiffness, strength, and dimensional stability.

**carpet pad**  
A pad of cellular rubber or felted animal hair, over which carpet is installed to increase resiliency, improve durability, and reduce impact sound transmission. Also called carpet cushion.

# FORCE

An influence on a body producing or tending to produce a change in shape or movement.

## vector

A quantity possessing both magnitude and direction, represented by an arrow whose length is proportional to the magnitude and whose orientation in space represents the direction.

## line of action

A line of indefinite length of which a force vector is a segment. A force acting on a rigid body may be regarded as acting anywhere along its line of action without altering the external effect of the force.

## components of a force

Two or more concurrent forces into which a single force may be resolved and having a net effect on a rigid body equivalent to that of the initial force. For convenience in structural analysis, these are usually the rectangular or Cartesian components of the initial force.

## moment

The tendency of a force to produce rotation of a body about a point or line, equal in magnitude to the product of the force and the moment arm and acting in a clockwise or counterclockwise direction.

## moment center

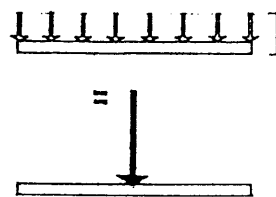
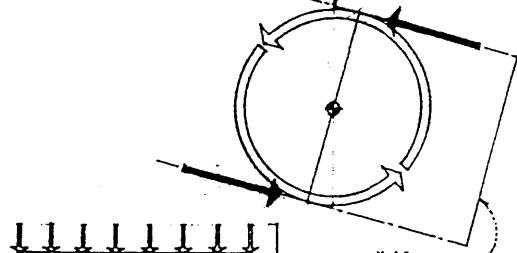
The point at which the axis of a moment intersects the plane of the forces causing the moment.

## moment arm

The perpendicular distance from the line of action of a force to the point or line about which a moment occurs. Also called force arm.

## couple

A force system of two equal, parallel forces acting in opposite directions and tending to produce rotation but not translation. The moment of a couple is equal in magnitude to the product of one of the forces and the perpendicular distance between the two forces.



**parallel forces**  
Nonconcurrent forces having parallel lines of action.

**nonconcurrent forces**  
Forces having lines of action that do not intersect at a common point, the vector sum of which is a single force that would cause the same translation and rotation of a body as the set of original forces.

## collinear forces

Concurrent forces having the same line of action, the vector sum of which is the algebraic sum of the magnitudes of the forces, acting along the same line of action.

## coplanar forces

Forces that operate in a single plane.

## concurrent forces

Forces having lines of action intersecting at a common point, the vector sum of which can be found by applying the parallelogram law.

## parallelogram law

The proposition that the vector sum of two concurrent forces can be described by the diagonal of a parallelogram having adjacent sides which represent the two force vectors being added.

## vector sum

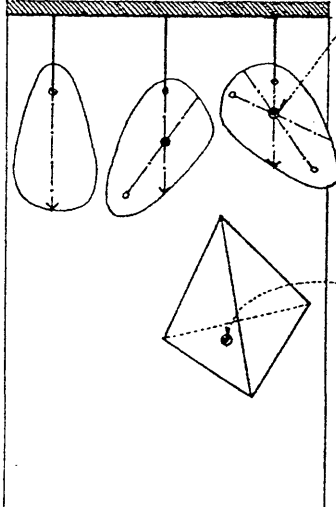
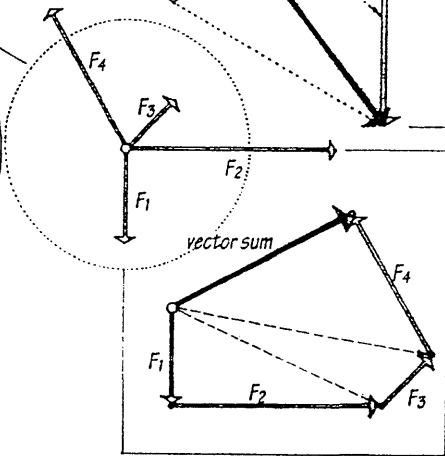
A single vector equivalent to and producing the same effect on a body as the application of two or more given vectors. Also called resultant.

## triangle method

A graphic technique for finding the vector sum of two concurrent forces by displacing one force vector parallel to itself until its tail coincides with the head of the other and completing the triangle with a vector that represents the resultant force.

## polygon method

A graphic technique for finding the vector sum of a coplanar system of several concurrent forces by drawing to scale each force vector in succession, with the tail of each at the head of the one preceding it, and completing the polygon with a vector that represents the resultant force, extending from the tail of the first to the head of the last vector.



## center of gravity

The point at which the entire weight of a body may be considered concentrated so that, if supported at this point, the body would remain in equilibrium in any position; coincident with the center of mass in a uniform gravitational field. A force whose line of action passes through the center of gravity of a body affects only its translational equilibrium; the body remains in rotational equilibrium.

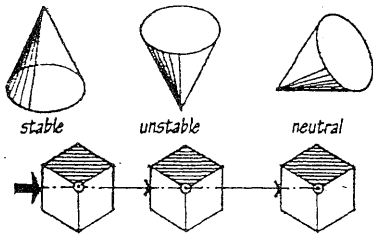
## center of mass

The point at which the entire mass of a body may be considered concentrated such that the moment about any line through the point is zero.

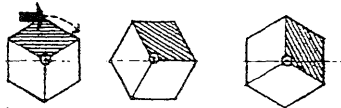
## centroid

The center of a one- or two-dimensional figure, about which the sum of the displacements of all points in the figure is zero.





**translation**  
The uniform motion of a body in a straight line, without rotation or angular displacement.



**rotation**  
The circular motion of a body about an axis.

**lever**  
A rigid element that pivots about a fulcrum to exert a pressure or sustain a weight at a second point by a force applied at a third.

**fulcrum**  
The point or support about which a lever turns.

**mechanical advantage**  
The ratio of output force to the input force applied to a mechanism.

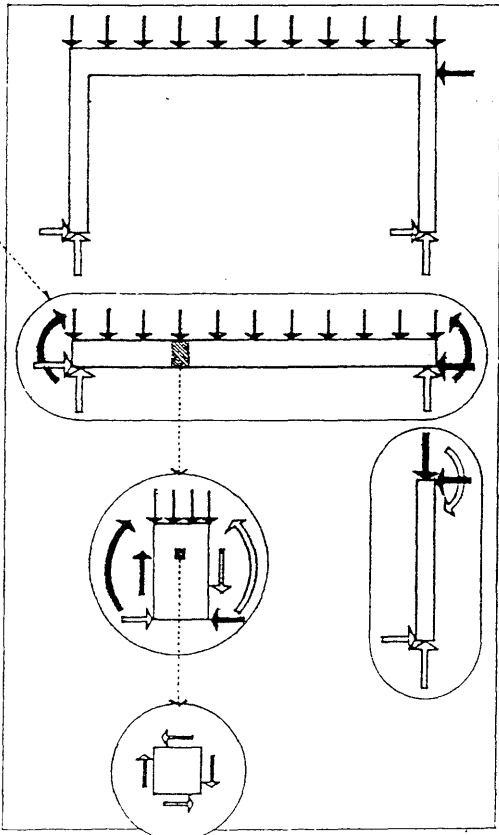
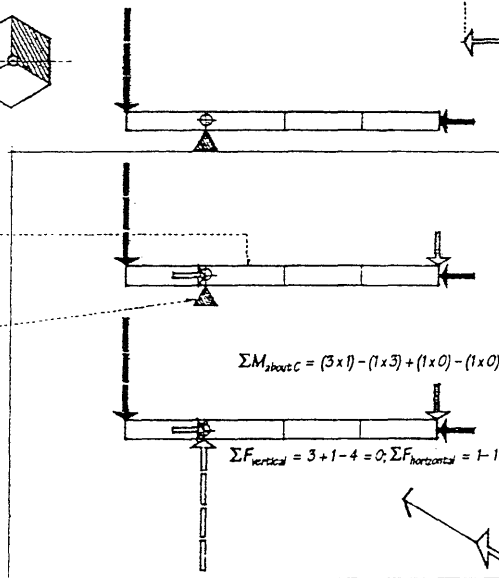
**free-body diagram**  
A graphic representation of the complete system of applied and reactive forces acting on a body or an isolated part of a structure. Every elementary part of a structural system has reactions that are necessary for the equilibrium of the part, just as the larger system has reactions at its supports that serve to maintain the equilibrium of the whole. Also called **equilibrium diagram**.

**mechanics**  
The branch of physics that deals with the effects of forces on bodies or material systems, comprised of statics and dynamics.

**statics**  
The branch of mechanics that deals with the relations of forces producing equilibrium among bodies or material systems.

**dynamics**  
The branch of mechanics that deals with the motion and equilibrium of bodies or material systems under the action of forces.

**statically equivalent**  
Having the same translational and rotational effect on a body.



**1 Newton's first law of motion**  
The physical law that a body remains at rest or in motion with a constant velocity unless an external force acts on the body. Also called law of inertia.

**inertia**  
The tendency of a body at rest to remain at rest or of a body in motion to retain its velocity along a straight line unless acted upon by an external force.

**equilibrant**  
The force required to bring a set of concurrent forces into equilibrium, equal in magnitude but opposite in direction to the resultant of the concurrent force system and acting along the same line of action.

**equilibrium**  
A state of balance or rest resulting from the equal action of opposing forces. For a rigid body to be in equilibrium, two conditions are necessary. First, the vector sum of all forces acting on it must equal zero, ensuring translational equilibrium:  $\Sigma F_x = 0; \Sigma F_y = 0; \Sigma F_z = 0$ . Second, the algebraic sum of all moments of the forces about any point or line must equal zero, ensuring rotational equilibrium:  $\Sigma M = 0$ .

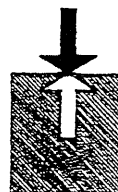
**2 Newton's second law of motion**  
The physical law that the sum of the forces acting on a body is equal to the product of the mass of the body and the acceleration produced by the force, with motion in the direction of the resultant of the forces.

force ( $F$ ) = mass ( $m$ ) x acceleration ( $a$ )  
mass ( $m$ ) =  $F/a$  = weight ( $w$ ) / gravitational force ( $g$ )

**3 Newton's third law of motion**  
The physical law that for every force acting on a body, the body exerts a force having equal magnitude and the opposite direction along the same line of action as the original force. Also called the law of action and reaction.

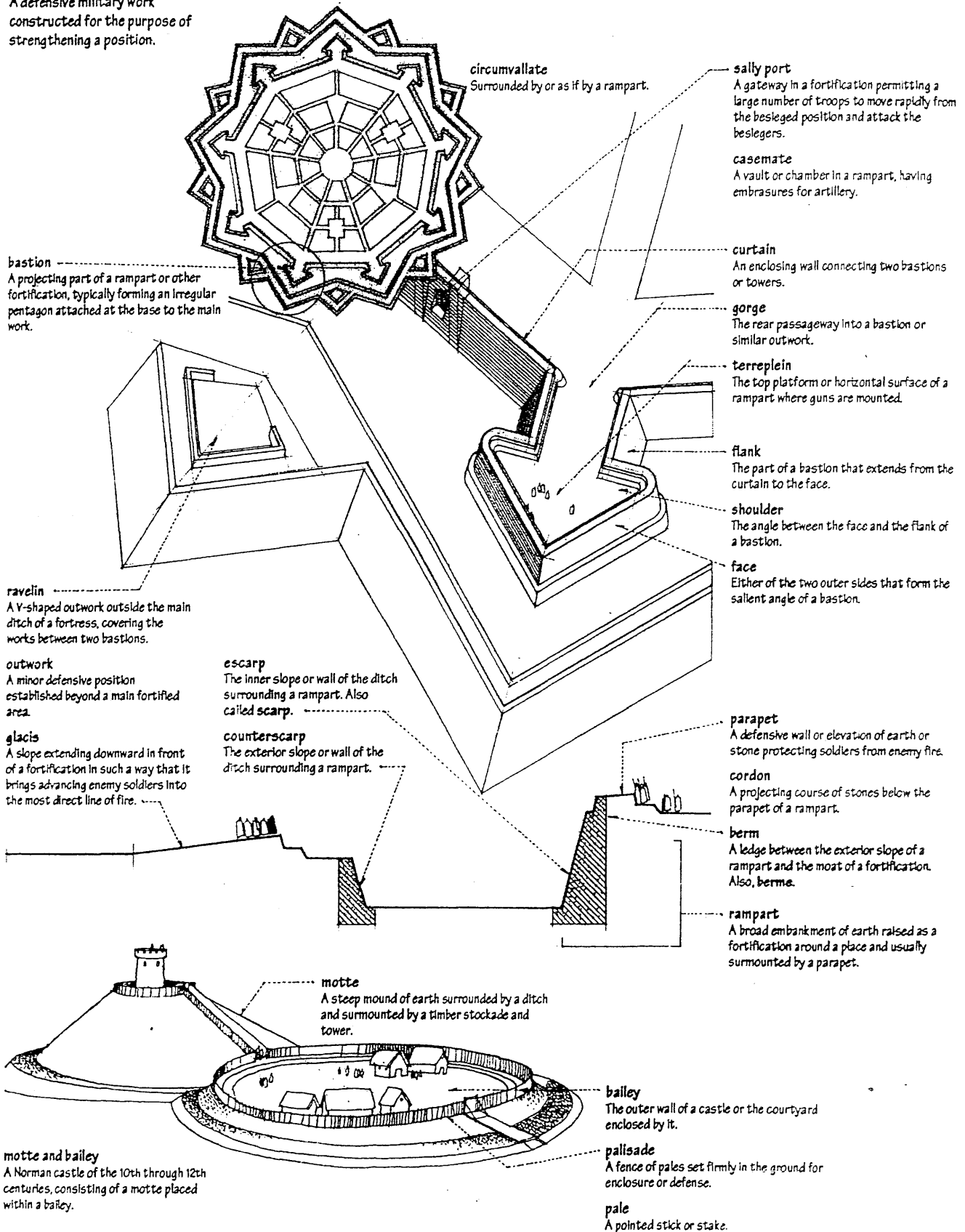
**applied force**  
An external force acting directly on a body.

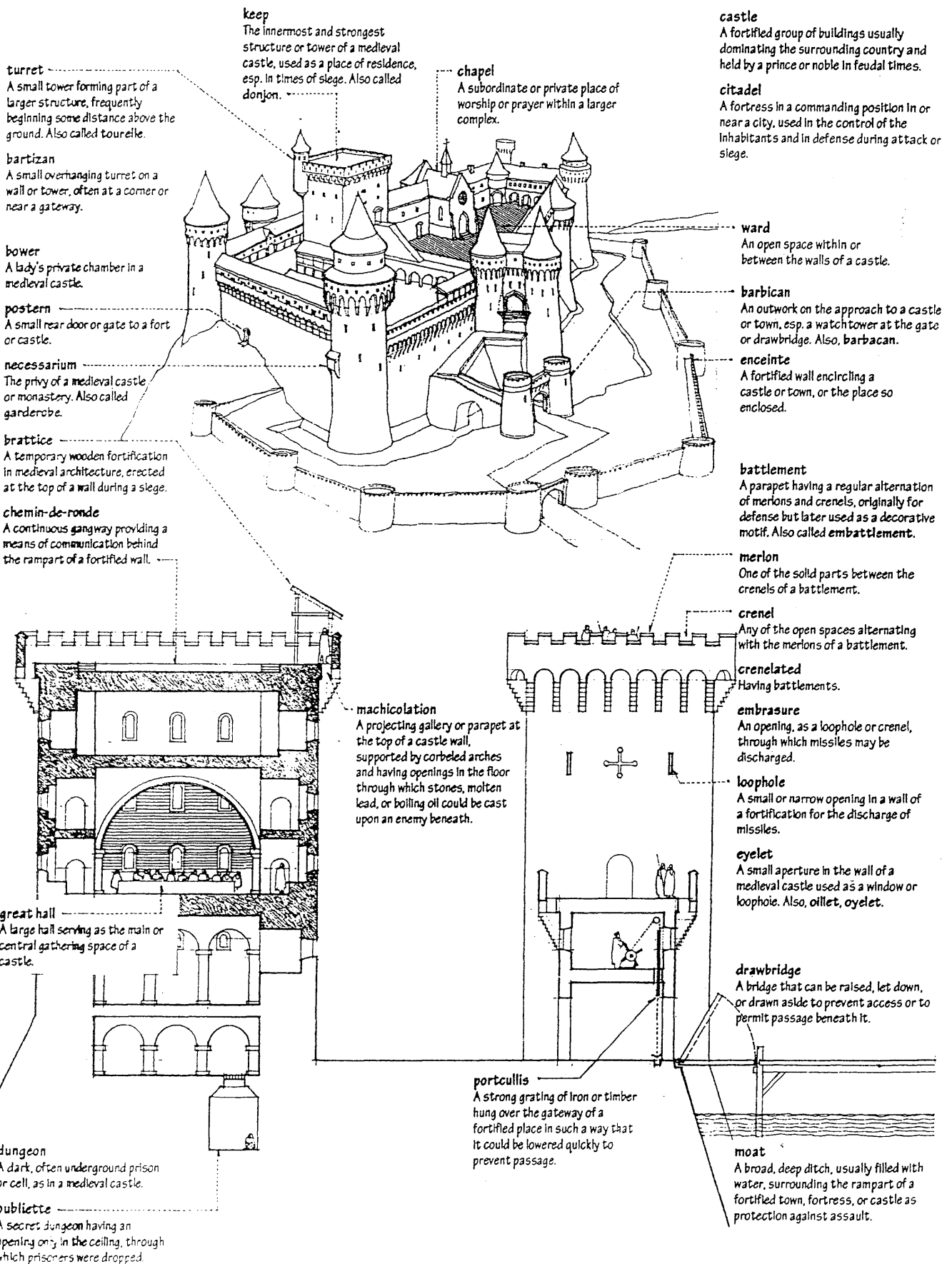
**reactive force**  
An external force generated by the action of one body on another.



# FORTIFICATION

A defensive military work constructed for the purpose of strengthening a position.





**turret**  
A small tower forming part of a larger structure, frequently beginning some distance above the ground. Also called *tourelle*.

**bartizan**  
A small overhanging turret on a wall or tower, often at a corner or near a gateway.

**bower**  
A lady's private chamber in a medieval castle.

**postern**  
A small rear door or gate to a fort or castle.

**necessarium**  
The privy of a medieval castle or monastery. Also called *garderobe*.

**brattice**  
A temporary wooden fortification in medieval architecture, erected at the top of a wall during a siege.

**chemin-de-ronde**  
A continuous gangway providing a means of communication behind the rampart of a fortified wall.

**keep**  
The innermost and strongest structure or tower of a medieval castle, used as a place of residence, esp. in times of siege. Also called *donjon*.

**chapel**  
A subordinate or private place of worship or prayer within a larger complex.

**castle**  
A fortified group of buildings usually dominating the surrounding country and held by a prince or noble in feudal times.

**citadel**  
A fortress in a commanding position in or near a city, used in the control of the inhabitants and in defense during attack or siege.

**ward**  
An open space within or between the walls of a castle.

**barbican**  
An outwork on the approach to a castle or town, esp. a watchtower at the gate or drawbridge. Also, *barbacan*.

**enceinte**  
A fortified wall encircling a castle or town, or the place so enclosed.

**battlement**  
A parapet having a regular alternation of merlons and crenels, originally for defense but later used as a decorative motif. Also called *embattlement*.

**merlon**  
One of the solid parts between the crenels of a battlement.

**crenel**  
Any of the open spaces alternating with the merlons of a battlement.

**crenelated**  
Having battlements.

**embrasure**  
An opening, as a loophole or crenel, through which missiles may be discharged.

**loophole**  
A small or narrow opening in a wall of a fortification for the discharge of missiles.

**eyelet**  
A small aperture in the wall of a medieval castle used as a window or loophole. Also, *oilet*, *oyelet*.

**machicolation**  
A projecting gallery or parapet at the top of a castle wall, supported by corbeled arches and having openings in the floor through which stones, molten lead, or boiling oil could be cast upon an enemy beneath.

**great hall**  
A large hall serving as the main or central gathering space of a castle.

**dungeon**  
A dark, often underground prison or cell, as in a medieval castle.

**oubliette**  
A secret dungeon having an opening only in the ceiling, through which prisoners were dropped.

**drawbridge**  
A bridge that can be raised, let down, or drawn aside to prevent access or to permit passage beneath it.

**portcullis**  
A strong grating of iron or timber hung over the gateway of a fortified place in such a way that it could be lowered quickly to prevent passage.

**moat**  
A broad, deep ditch, usually filled with water, surrounding the rampart of a fortified town, fortress, or castle as protection against assault.

# FOUNDATION

The lowest division of a building or other construction, partly or wholly below the surface of the ground, designed to support and anchor the superstructure and transmit its loads directly to the earth.

## shallow foundation

A foundation system placed directly below the lowest part of a substructure and transferring building loads directly to the supporting soil by vertical pressure.

## footing

The part of a foundation bearing directly upon the supporting soil, set below the frostline and enlarged to distribute its load over a greater area.

## settlement

The gradual subsiding of a structure as the soil beneath its foundation consolidates under loading.

## consolidation

The gradual reduction in the volume of a soil mass resulting from the application of a sustained load and an increase in compressive stress.

## primary consolidation

A reduction in volume of a soil mass under the action of a sustained load, due chiefly to a squeezing out of water from the voids within the mass and a transfer of the load from the soil water to the soil solids. Also called primary compression.

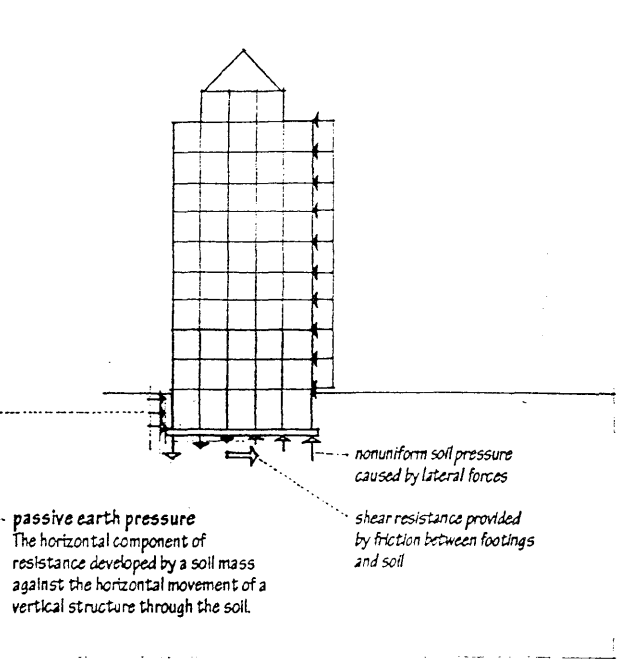
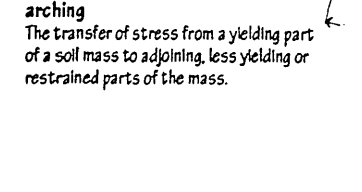
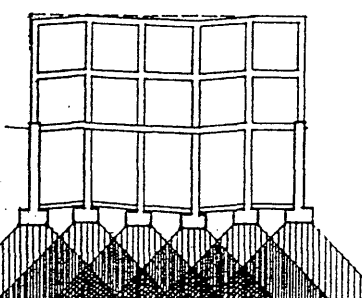
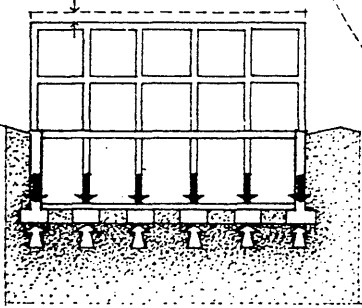
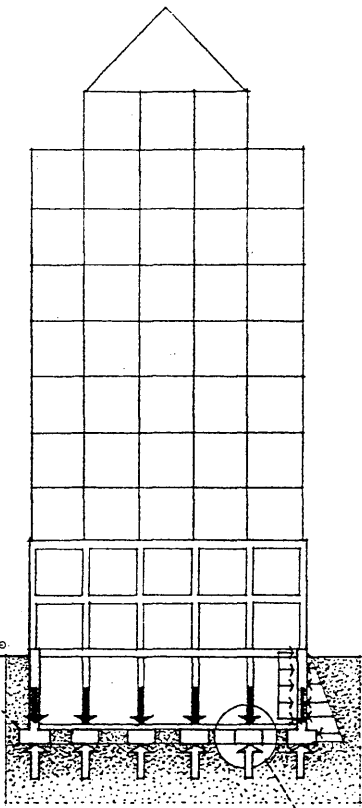
## secondary consolidation

A reduction in volume of a soil mass under the action of a sustained load, due chiefly to adjustment of the internal structure of the soil mass after most of the load has been transferred from the soil water to the soil solids.

## differential settlement

The relative movement of different parts of a structure caused by uneven settlement or failure of its foundation.

Overlapping soil stresses may be caused by closely spaced footings or by adjacent footings located at different levels.



## passive earth pressure

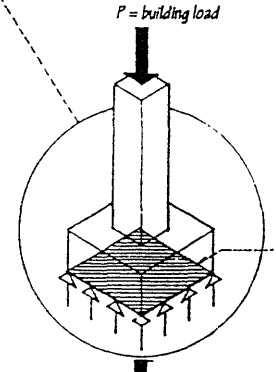
The horizontal component of resistance developed by a soil mass against the horizontal movement of a vertical structure through the soil.

## active earth pressure

The horizontal component of pressure that a soil mass exerts on a vertical retaining structure.

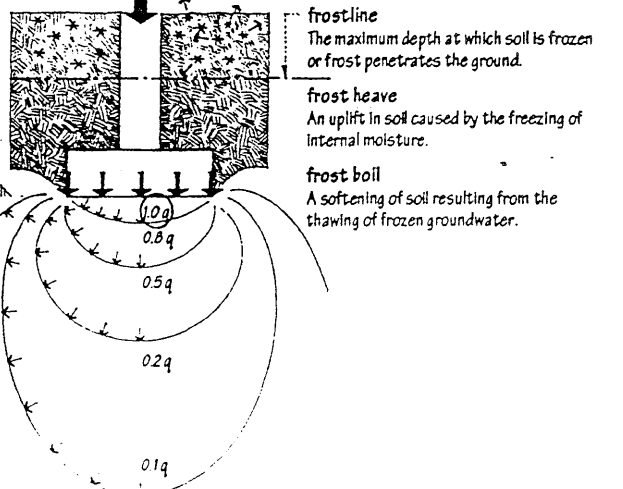
## soil pressure

The actual pressure developed between a footing and the supporting soil mass, equal to the quotient of the magnitude of the forces transmitted and the area of contact. Also called contact pressure.



## allowable bearing pressure

The maximum unit pressure a foundation is permitted to impose vertically or laterally on a supporting soil mass. Allowable bearing pressures for various soil classifications are conservative values permitted by building codes in the absence of geotechnical investigation and testing of the soil. Also called allowable bearing capacity, allowable soil pressure.



## arching

The transfer of stress from a yielding part of a soil mass to adjoining, less yielding or restrained parts of the mass.

**foundation wall**

A wall occurring below the floor nearest grade, designed to support and anchor the superstructure.

**ground slab**

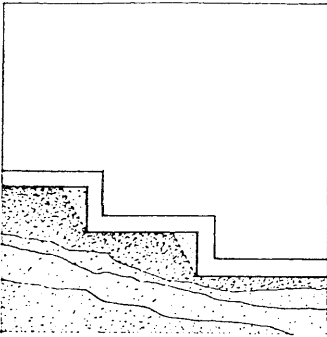
A concrete slab placed over a dense or compacted base and supported directly by the ground, usually reinforced with welded wire fabric or a grid of reinforcing bars to control any cracking caused by drying shrinkage or thermal stresses. Separate or integral footings are required for heavy or concentrated loads. Over problem soils, the slab must be designed as a mat or raft foundation. Also called slab on grade.

**base course**

A layer of coarse granular materials placed and compacted on undisturbed soil or prepared fill to prevent the capillary rise of moisture to a concrete ground slab.

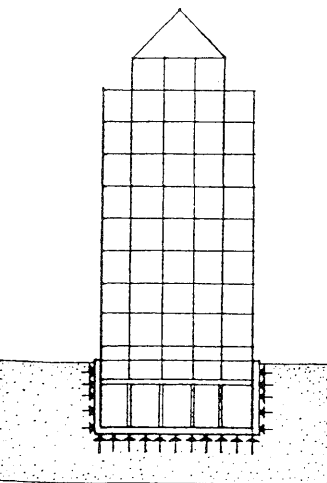
**substratum**

Something that underlies or serves as a base or foundation. Also called substrate.



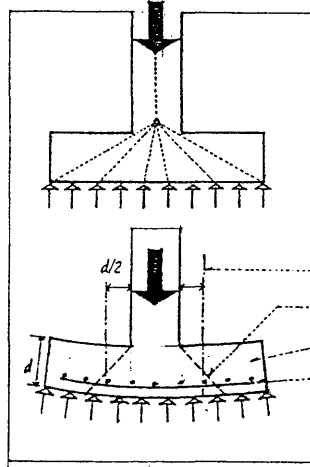
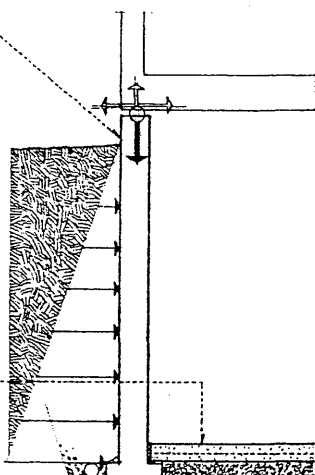
**stepped footing**

A continuous or strip footing that changes levels in stages to accommodate a sloping site or bearing stratum.



**floating foundation**

A foundation used in yielding soil, having for its footing a raft placed deep enough that the weight of the excavated soil is equal to or greater than the weight of the construction supported.



**spread footing**

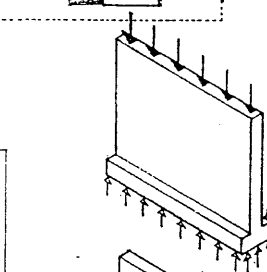
A concrete footing extended laterally to distribute the foundation load over a wide enough area that the allowable bearing capacity of the supporting soil is not exceeded.

critical section assumed for shear

actual punching shear

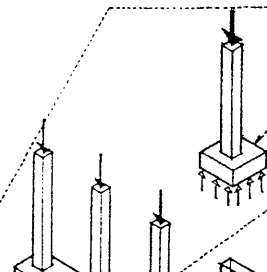
compression

tension



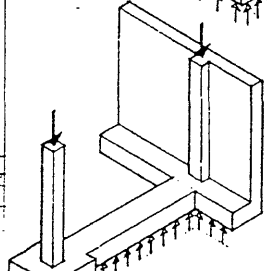
**strip footing**

The continuous spread footing of a foundation wall.



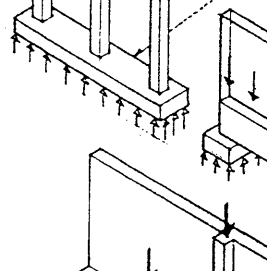
**isolated footing**

A single spread footing supporting a freestanding column or pier.



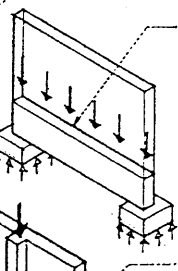
**cantilever footing**

A reinforced concrete footing connected by a tie beam to another footing in order to balance an asymmetrically imposed load, as at the perimeter of a building site. Also called strap footing.



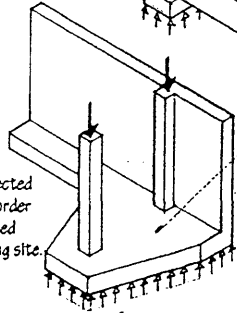
**continuous footing**

A reinforced concrete footing extended to support a row of columns.



**grade beam**

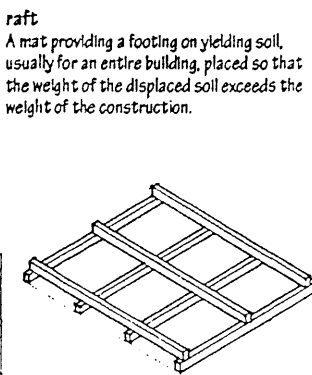
A reinforced concrete beam supporting a superstructure at or near ground level and transferring the load to isolated footings, piers, or piles. Also called ground beam.



**combined footing**

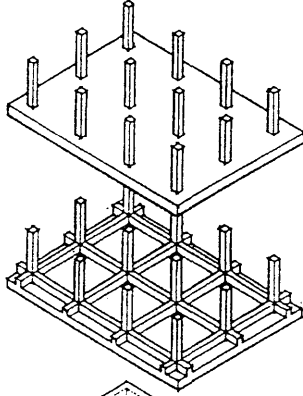
A reinforced concrete footing for a perimeter column or foundation wall extended to support an interior column load.

To avoid rotation or differential settlement, continuous and cantilever footings are proportioned to generate uniform soil pressure.



**raft**

A mat providing a footing on yielding soil, usually for an entire building, placed so that the weight of the displaced soil exceeds the weight of the construction.

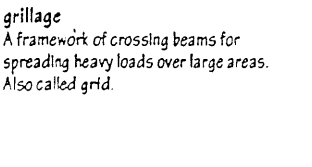


**mat**

A thick, slablike footing of reinforced concrete supporting a number of columns or an entire building.

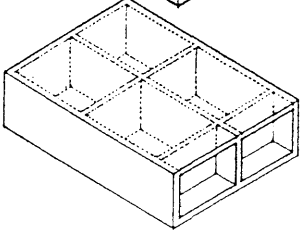
**ribbed mat**

A mat foundation reinforced by a grid of ribs above or below the slab.



**grillage**

A framework of crossing beams for spreading heavy loads over large areas. Also called grid.



**cellular mat**

A composite structure of reinforced concrete slabs and basement walls serving as a mat foundation.

# FOUNDATION

## deep foundation

A foundation system that extends down through unsuitable soil to transfer building loads to a more appropriate bearing stratum well below the superstructure.

## pile foundation

A system of piles, pile caps, and tie beams for transferring building loads down to a suitable bearing stratum, used esp. when the soil mass directly below the construction is not suitable for the direct bearing of footings.

## bearing stratum

A stratum of soil or rock on which a footing bears, or to which a building load is transferred by a pile or caisson.

## pile

A long slender column of wood, steel, or reinforced concrete, driven or hammered vertically into the earth to form part of a foundation system.

## end-bearing pile

A pile depending principally on the bearing resistance of soil or rock beneath its foot for support. The surrounding soil mass provides a degree of lateral stability for the long compression member. Also called point-bearing pile.

## allowable pile load

The maximum axial and lateral loads permitted on a pile, as determined by a dynamic pile formula, a static load test, or a geotechnical investigation of the foundation soil.

## pile eccentricity

The deviation of a pile from its plan location or from the vertical, resulting in a reduction of its allowable load.

## pile tolerance

The permitted deviation of a pile from the vertical for which a reduction in allowable load is not required.

## friction pile

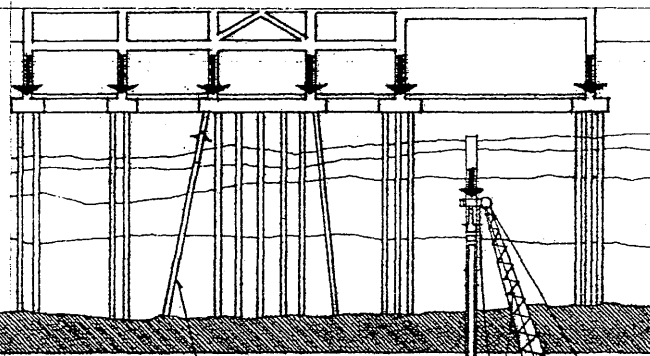
A pile depending principally on the frictional resistance of surrounding earth for support.

## skin friction

The friction developed between the sides of a pile and the soil into which the pile is driven, limited by the adhesion of soil to the pile sides and the shear strength of the surrounding soil mass.

## negative friction

An additional load on a pile resulting from settling of fill, which tends to drag the pile downward into the soil.



## batter pile

A pile driven at a specified angle to the vertical in order to provide resistance against lateral forces.

## drive band

A steel band encircling the head of a timber pile to prevent it from splitting when driven. Also called pile ring.

## anvil

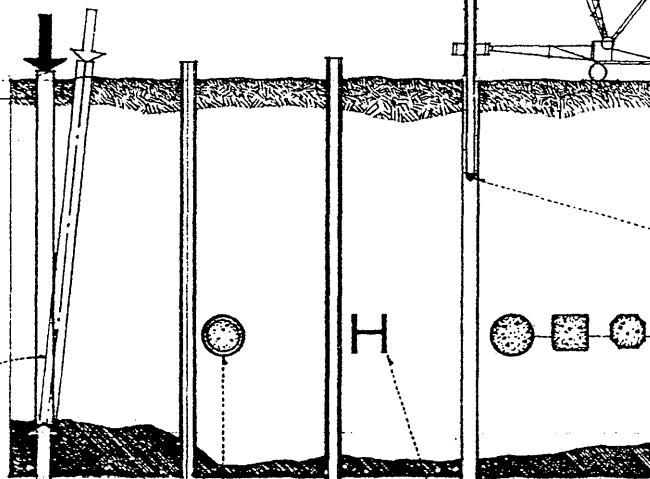
The component of a pile hammer, located just below the ram, that transfers the driving force to the pile head.

## cushion

A cap for protecting a pile head as well as the pile hammer during a driving operation. Also called cushion block, cushion head.

## pile driver

A machine for driving piles, usually composed of a tall framework supporting machinery for lifting a pile in position before driving, a driving hammer, and vertical rails or leads for guiding the hammer.



## timber pile

A log driven usually as a friction pile, often fitted with a steel shoe and a drive band to prevent it from splitting or shattering.

## shoe

The hard, pointed or rounded foot of a pile or caisson for piercing underlying soil. Also called drive shoe.

## precast concrete pile

A precast, often prestressed concrete column, having a round, square, or polygonal section and sometimes an open core, driven into the earth by a pile driver until it meets the required resistance.

## pipe pile

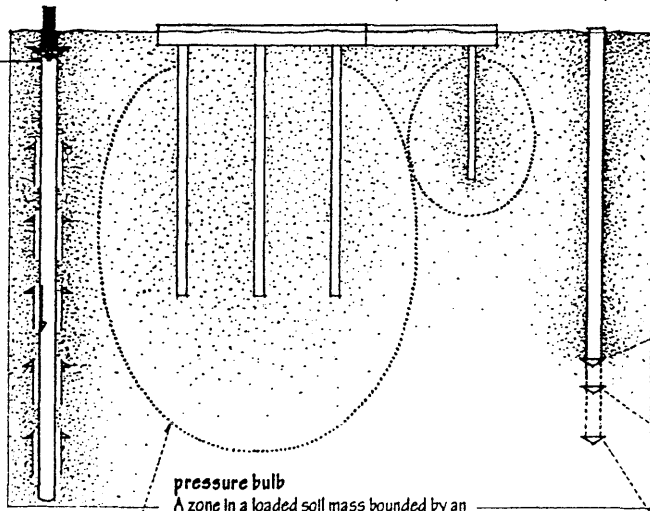
A heavy steel pipe driven with the lower end either open or closed by a heavy steel plate or point and filled with concrete. An open-ended pipe pile requires inspection and excavation before being filled with concrete.

## H-pile

A steel H-section driven as a pile, sometimes encased in concrete to a point below the water table to prevent corrosion. H-sections can be welded together in the driving process to form any length of pile.

## composite pile

A pile constructed of two materials, as a timber pile having a concrete upper section to prevent the portion of the pile above the water table from deteriorating.



## dynamic pile formula

Any of several formulas by which the allowable axial load on a pile can be calculated from the energy required for a pile hammer to advance the pile foot a specified distance into the subsoil.

## static load test

A test for determining the allowable axial load on a single pile, usually a fraction of the load required to reach a yield point, a point of resistance, or a point of refusal.

## point of resistance

The point at which a pile load causes a specified net settlement after being applied continuously for a specified period of time.

## point of refusal

The point at which no additional settlement takes place after a pile has been loaded continuously for a specified period of time.

## yield point

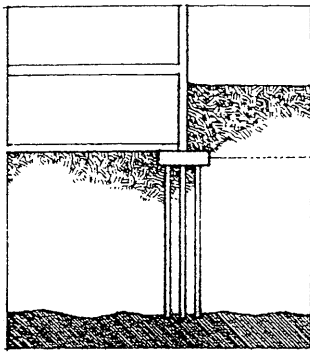
The point at which an increase in pile load produces a disproportionate increase in settlement.

## pressure bulb

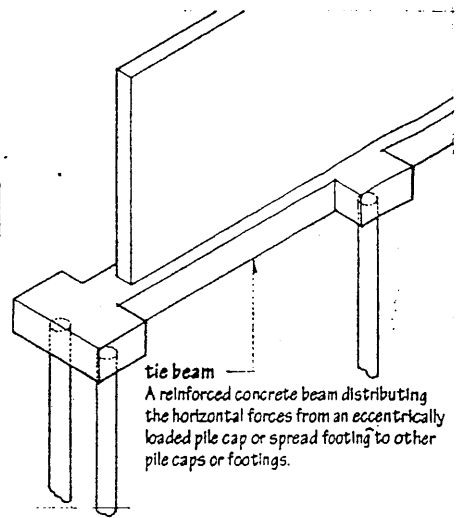
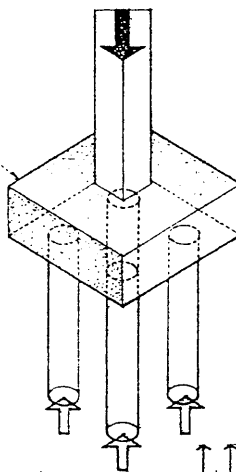
A zone in a loaded soil mass bounded by an arbitrarily selected isobar of stress, as from a single or number of friction piles.

## isobar

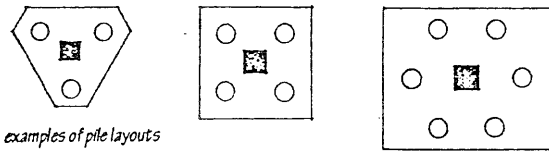
A line connecting points of equal pressure.



**pile cap**  
A reinforced concrete slab or mat joining the heads of a cluster of piles to distribute the load from a column or grade beam equally among the piles.



**tie beam**  
A reinforced concrete beam distributing the horizontal forces from an eccentrically loaded pile cap or spread footing to other pile caps or footings.



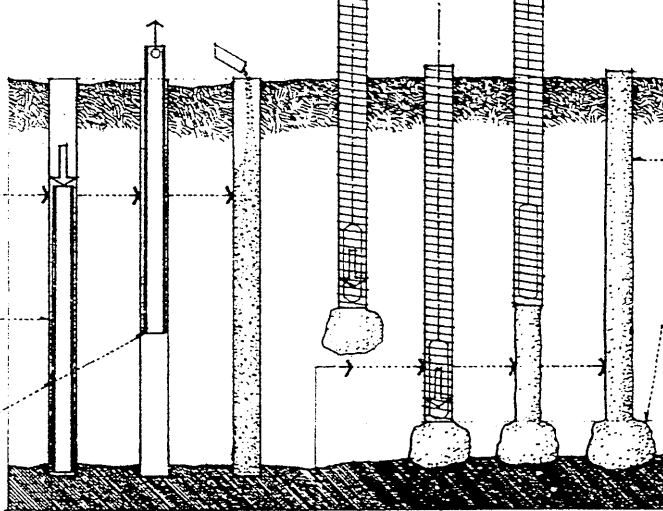
examples of pile layouts

**cast-in-place concrete pile**  
A pile constructed by placing concrete into a shaft in the ground.

**cased pile**  
A concrete pile constructed by driving a steel pipe or casing into the ground until it meets the required resistance and then filling it with concrete.

**casing**  
A cylindrical steel section, sometimes corrugated or tapered for increased stiffness, driven or dropped in place to serve as a form for a cast-in-place concrete pile.

**mandrel**  
A heavy steel tube or core that is inserted into a thin-walled casing to prevent it from collapsing in the driving process, and then withdrawn before concrete is placed in the casing.



**pedestal pile**  
A cast-in-place concrete pile having an enlarged foot to increase its bearing area and strengthen the bearing stratum by compression, formed by forcing concrete out at the bottom of the casing into the surrounding soil.

**bulb**  
A bulge cast or formed at the bottom of a cast-in-place concrete pile to enlarge its bearing area and strengthen the bearing stratum by compression.

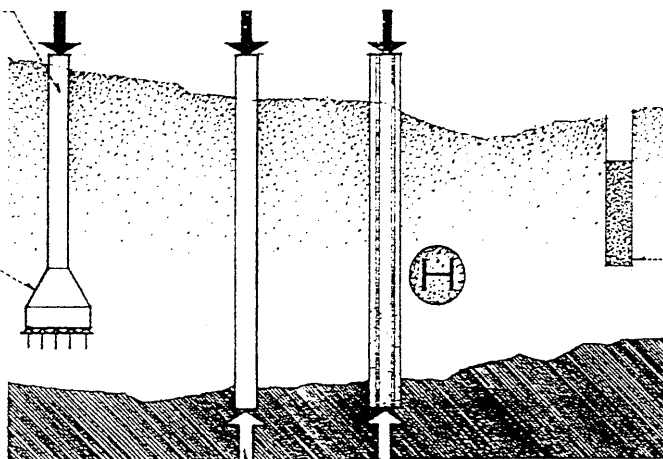
**uncased pile**  
A concrete pile constructed by driving a concrete plug into the ground along with a steel casing until it meets the required resistance, and then ramming concrete into place as the casing is withdrawn.

**pier**  
A cast-in-place concrete foundation formed by boring with a large auger or excavating by hand a shaft in the earth to a suitable bearing stratum and filling the shaft with concrete.

**caisson**  
A pier, esp. when the boring is 2 ft. (610 mm) or larger in diameter to permit inspection of the bottom.

**bell**  
The base of a caisson enlarged to increase its bearing area.

**bell bucket**  
An attachment to an earth auger having expanding blades for excavating a bell at the bottom of a caisson shaft.



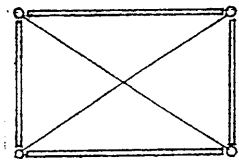
**sand pile**  
A base for a footing in soft soil, made by compacting sand in a cavity left by a timber pile.

**socketed caisson**  
A caisson that is drilled into a stratum of solid rock rather than belled.

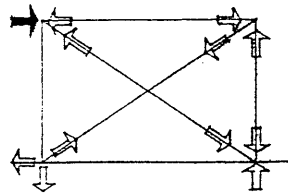
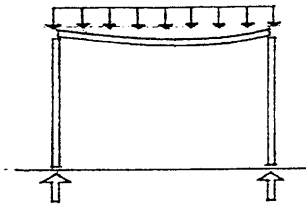
**rock caisson**  
A socketed caisson having a steel H-section core within a concrete-filled pipe casing.

# FRAME

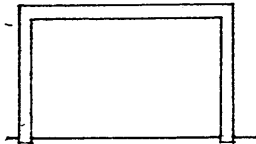
A skeletal structure of relatively slender members designed to give shape and support to a building or other construction.



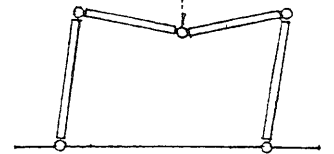
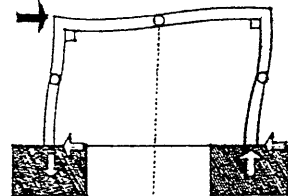
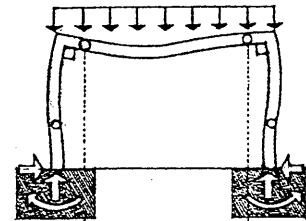
**braced frame**  
A structural frame whose resistance to lateral forces is provided by diagonal or other type of bracing.



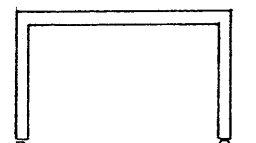
**plastic hinge**  
A virtual hinge that develops when all fibers are fully yielded at a cross section of a structural member.



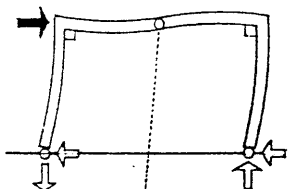
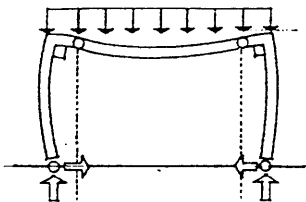
**rigid frame**  
A structural frame of linear members rigidly connected at their joints. Applied loads produce axial, bending, and shear forces in all members of the frame since the rigid joints restrain the ends of the members from rotating freely. In addition, vertical loads cause a rigid frame to develop horizontal thrusts at its base. A rigid frame is statically indeterminate and rigid only in its plane. Also called moment-resisting frame.



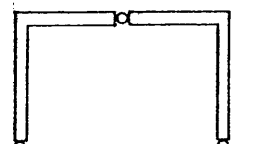
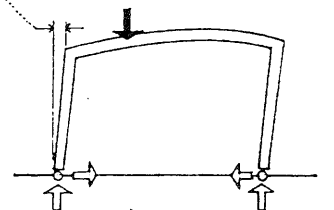
**fixed frame**  
A rigid frame connected to its supports with fixed joints. A fixed frame is more resistant to deflection than a hinged frame but also more sensitive to support settlements and thermal expansion and contraction.



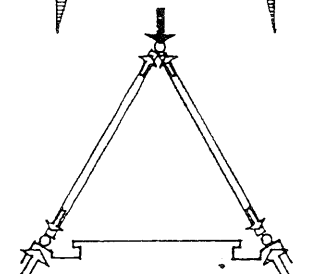
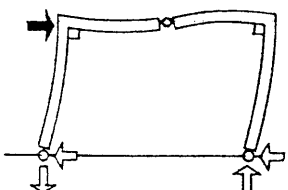
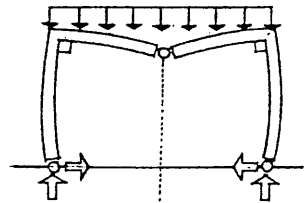
**hinged frame**  
A rigid frame connected to its supports with pin joints. The pin joints prevent high bending stresses from developing by allowing the frame to rotate as a unit when strained by support settlements, and to flex slightly when stressed by changes in temperature.



**sideway**  
The lateral displacement produced in a rigid frame by lateral loads or asymmetrical vertical loading.



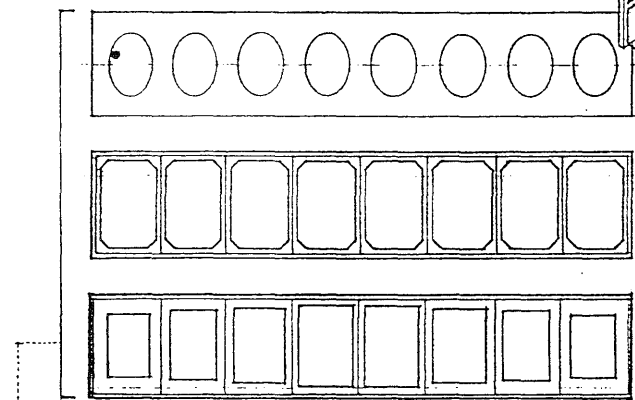
**three-hinged frame**  
A structural assembly of two rigid sections connected to each other and to its supports with pin joints. While more sensitive to deflection than either the fixed or hinged frame, the three-hinged frame is least affected by support settlements and thermal stresses. The three pin joints also permit the frame to be analyzed as a statically determinate structure.



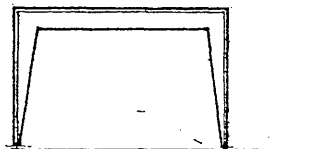
**A-frame**  
A building constructed with a steep triangular frame resting directly on a foundation.



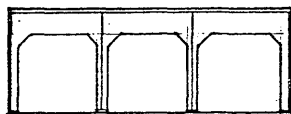
**knee**  
The junction of the top and either of the uprights of a bent.



**bent**  
A braced or rigid frame designed to carry vertical and lateral loads transverse to the length of a framed structure.



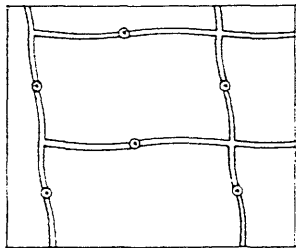
**portal**  
A rigid frame of two columns and a beam defining a single bay. Also called single-bay frame.



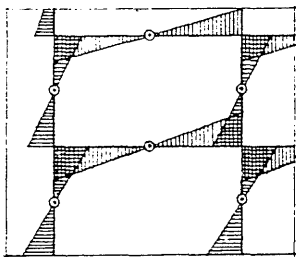
**multibay frame**  
A rigid frame having a continuous beam supported by and rigidly connected to three or more columns.

**Vierendeel truss**  
A framed beam structure having vertical web members rigidly connected to parallel top and bottom chords. A Vierendeel truss is not a true truss since its members are subject to nonaxial bending forces. Also called Vierendeel girder.

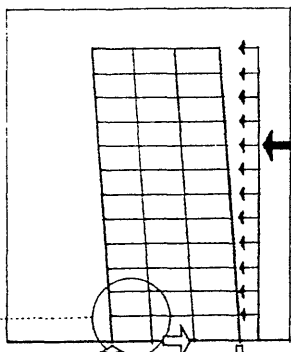
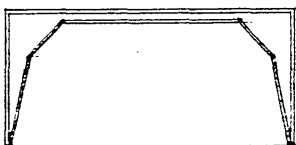
**portal method**  
A method for analyzing a multistory frame as a cantilever dominated by shear racking. The portal method assumes that a point of inflection occurs at the midlength of all members in the frame, and that the frame acts as a series of independent portals to which the total lateral shear at each level is distributed in proportion to the floor area each column supports. Imaginary pin joints can be inserted at each point of inflection, making the frame a statically determinate structure.



**cantilever method**  
A method for analyzing a multistory frame as a cantilever subject to bending. The cantilever method assumes that a point of inflection occurs at the midlength of all members in the frame, and that the axial force in each column of a story is proportional to its horizontal distance from the centroid of all the columns on that level. Imaginary pin joints can be inserted at each point of inflection, making the frame a statically determinate structure.

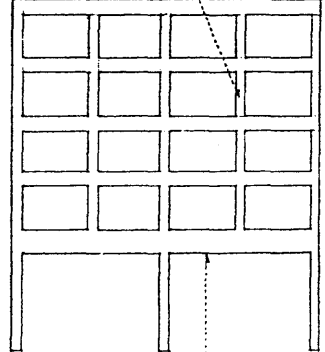


**moment distribution method**  
A method for analyzing an indeterminate structure through an iterative process of fixing a rigid joint in space, determining the fixed-end moments at the joint, then releasing the joint to allow it to rotate, and studying the transference of moments and rotations to other joints.

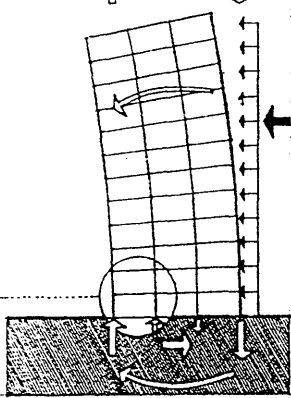


**multistory frame**  
A vertical series of superimposed rigid frames.

**transfer column**  
A discontinuous column in a multistory frame, supported at some intermediate level where its load is transferred to adjacent columns.



**transfer girder**  
A girder supporting a transfer column.



**indeterminate**  
Of or pertaining to a structure having more than the minimum number of members, connections, or supports needed for stability, resulting in more unknown forces than there are static equations for solution.

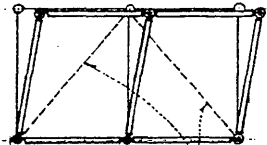
**degree of indeterminacy**  
The difference between the number of unknown forces in an indeterminate structure and the number of static equations available for solution.

**determinate**  
Of or pertaining to a structure able to be analyzed completely by means of the principles of statics.

**redundancy**  
A structural member, connection, or support not required for a statically determinate structure.

**degree of redundancy**  
The number of members beyond that required for the stability of a statically determinate structure.

**degree of freedom**  
The number of members required to stabilize a collapse mechanism.



# FRAME

## framing

The act, process, or manner of fitting and joining together relatively slender members to give shape and support to a structure.

## framework

A skeletal structure of parts fitted and joined together in order to support, define, or enclose.

## skeleton construction

A system of construction utilizing a framework of columns and beams to transmit building loads down to the foundation.

## plank-and-beam construction

Floor or roof construction utilizing a framework of timber beams to support wood planks or decking.

## post-and-beam construction

Wall construction utilizing a framework of vertical posts and horizontal beams to carry floor and roof loads. Also called post-and-lintel construction.

## pole construction

A system of construction employing a vertical structure of pressure-treated wood poles which are firmly embedded in the ground as a pier foundation.

## light frame construction

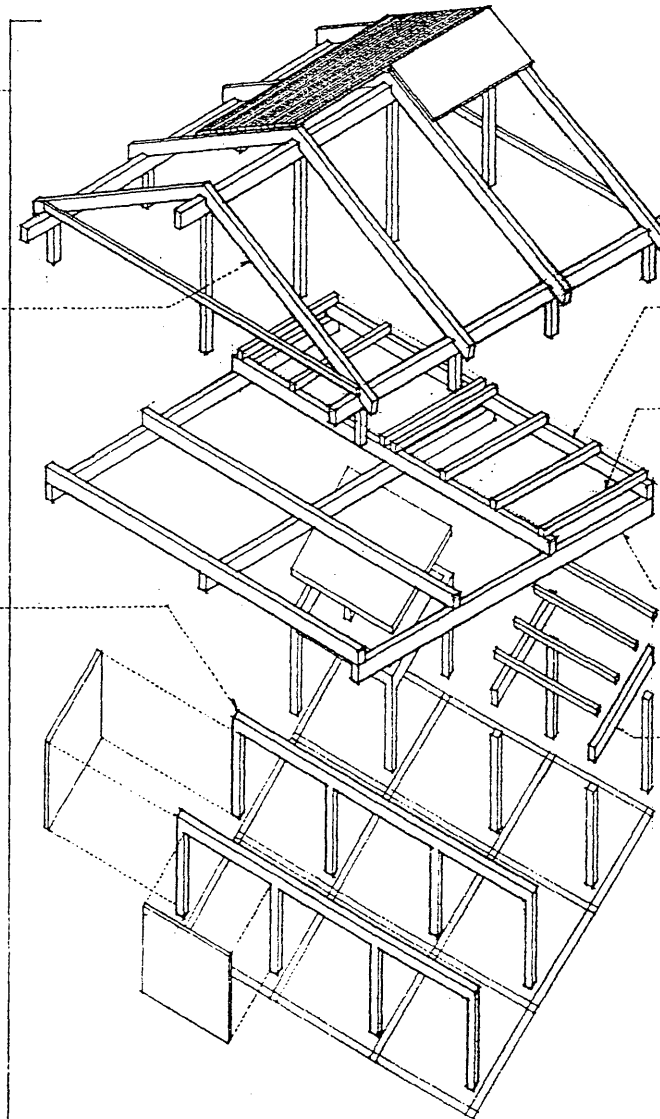
A system of construction utilizing closely spaced and sheathed members of dimension lumber or light-gauge metal to form the structural elements of a building.

\*See balloon frame

floor framing

platform frame

roof framing



## principal beam

Any large beam in a structural frame that supports secondary beams or joists. Also called primary beam.

## secondary beam

Any beam that transmits its load to a principal beam.

## tertiary beam

Any beam that transmits its load to a secondary beam.

## girder

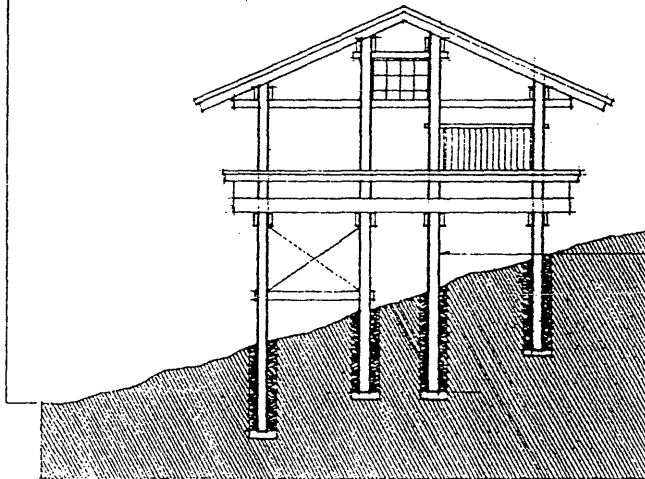
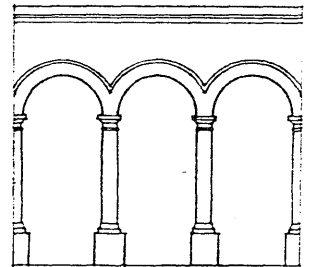
A large principal beam designed to support concentrated loads at isolated points along its length.

## trabeate

Of or pertaining to a system of construction employing beams or lintels. Also, trabeated.

## arcuate

Of or pertaining to a system of construction employing arches or arched forms. Also, arcuated.



## pole house

A house of pole construction.

## pole

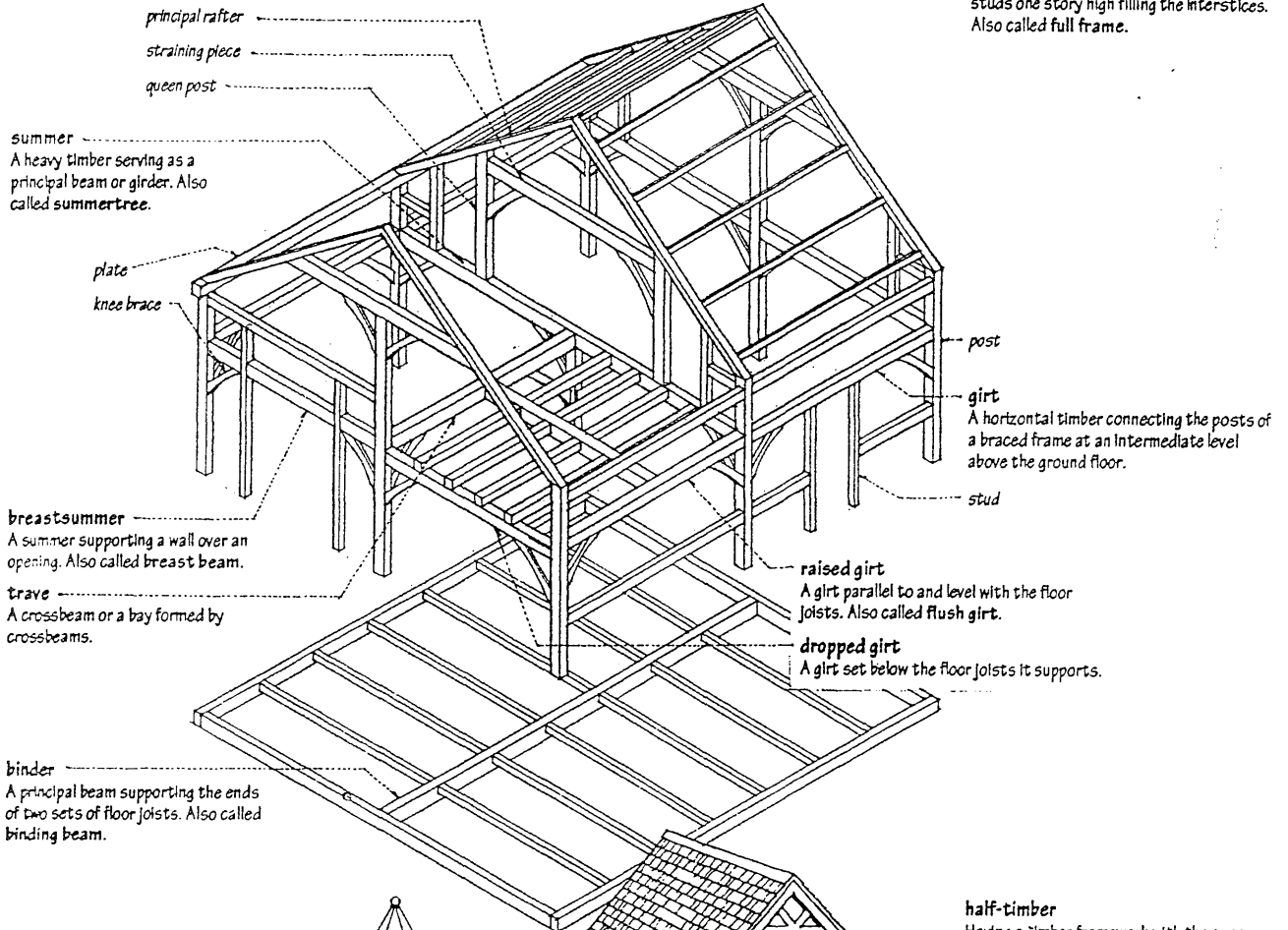
A long, cylindrical, often slender piece of wood or metal.

## stilt

One of several piles or posts for supporting a structure above the surface of land or water.

**braced frame**

A building frame employing a heavy, braced framework of solid girts mortised into solid posts the full height of the frame, with studs one story high filling the interstices. Also called full frame.



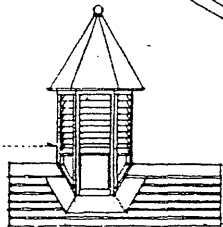
**summer**  
A heavy timber serving as a principal beam or girder. Also called summertree.

**breastsummer**  
A summer supporting a wall over an opening. Also called breast beam.

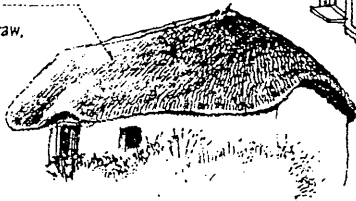
**trave**  
A crossbeam or a bay formed by crossbeams.

**binder**  
A principal beam supporting the ends of two sets of floor joists. Also called binding beam.

**louver**  
A lantern or turret on the roof of a medieval building having slatted apertures for the escape of smoke and admission of air.



**thatch**  
A material for covering a roof, as straw, rushes, or palm leaves, fastened together so as to shed water and sometimes to provide thermal insulation. Also, thatching.



**half-timber**

Having a timber framework with the spaces filled with masonry or plaster. Also, half-timbered.

**open-timbered**

Constructed so that a framework of timbers is exposed.



**solar**

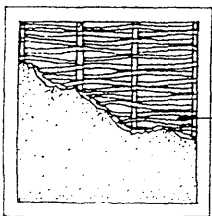
A room or apartment on an upper floor of a medieval English house. Also, solar, sollar, sollar.

**jetty**

An upper story of a building projecting beyond the one below. Also, jutting.

**pan**

A major vertical division of a wall, esp. a nogged panel of half-timber construction.



**wattle and daub**

A form of wall construction, consisting of wattles covered and plastered with clay or mud. Also, wattle and dab.

**wattle**

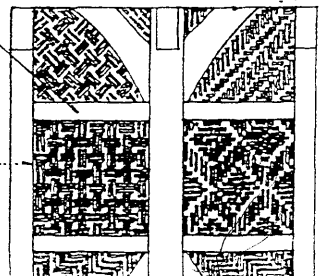
A framework of rods or poles interwoven with thin branches, twigs, and reeds, used in the construction of walls and fences.

**nog**

One of a number of short wooden pieces inserted between the principal members of a half-timbered wall to strengthen the frame and retain the brick infill. Also, nogg.

**nogging**

Brick masonry used to fill the spaces between the members of a timber frame.



# GEOMETRY

**A branch of mathematics that deals with the properties, measurement, and relationships of points, lines, angles, and solids, deduced from their defining conditions by means of certain assumed properties of space.**

**point**  
A dimensionless geometric element that has no property but location, as the intersection of two lines.

**y-axis**  
The axis along which ordinates or y-values are measured in a Cartesian coordinate system. Also called axis of ordinates.

**z-coordinate**  
A coordinate determined by measuring parallel to the z-axis.

**z-axis**  
The axis along which z-values are measured in a three-dimensional Cartesian coordinate system.

**rectangular coordinate system**  
A Cartesian coordinate system in which the axes or coordinate planes are perpendicular.

**x-axis**  
The axis along which abscissas or x-values are measured in a Cartesian coordinate system. Also called axis of abscissas.

**abscissa**  
A coordinate determined by measuring parallel to the x-axis. Also called x-coordinate.

**coordinate**  
Any of a set of numbers that serve to specify the location of a point on a line, surface, or in space by reference to a fixed figure or system of lines.

**Cartesian coordinate**  
Any of the coordinates for locating a point on a plane by its distance from each of two intersecting lines, or in space by its distance from each of three planes intersecting at a point.

**ordinate**  
A coordinate determined by measuring parallel to the y-axis. Also called y-coordinate.

**Euclidean geometry**  
Geometry based upon the postulates of Euclid, esp. the postulate that only one line may be drawn through a given point parallel to a given line.

**radius vector**  
A straight line segment that joins a variable point to the fixed origin of a polar coordinate system.

**polar angle**  
The angle formed by the polar axis and a radius vector in a polar coordinate system.

**polar axis**  
The reference axis from which the polar angle is measured in a polar coordinate system.

**polar coordinate system**  
A system for locating a point on a plane by its radius vector and polar angle.

**line**  
A geometric element generated by a moving point and having extension without breadth or thickness.

**vertical**  
Perpendicular to the plane of the horizon.

**oblique**  
Neither parallel nor perpendicular to a given line or surface.

**horizontal**  
Parallel to or operating in a plane parallel to the horizon.

**parallel**  
Extending in the same direction, equidistant at all points, and never converging or diverging.

**skew lines**  
Any lines in space that are neither parallel nor intersecting.

**angle**  
The space between two lines diverging from a common point, or within two planes diverging from a common line; the figure so formed.

**vertex**  
The point at which the sides of an angle intersect.

**angle**  
The amount of rotation needed to bring one line or plane into coincidence with another, measured in radians or in degrees, minutes, and seconds.

**radian**  
A unit of angular measure equal to the central angle subtending an arc equal in length to the radius:  $360/2\pi$  or approx.  $57.3^\circ$ .

**degree**  
A unit of angular measure, equal to  $1/360$ th of a complete angle or turn, or of the circumference of a circle.

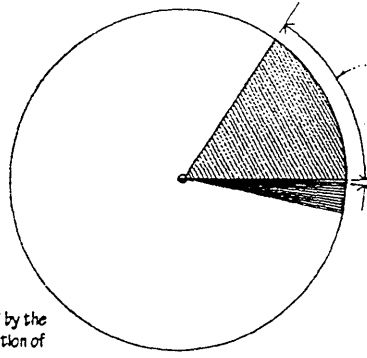
**minute**  
The 60th part of a degree of angular measure.

**second**  
The 60th part of a minute of angular measure.

**right angle**  
An angle of  $90^\circ$  formed by the perpendicular intersection of two straight lines.

**acute angle**  
An angle less than  $90^\circ$ .

**obtuse angle**  
An angle greater than  $90^\circ$ , but less than  $180^\circ$ .

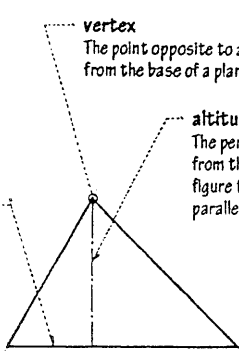


**height**  
Extent or distance upward from a given level to a fixed point.

**vertex**  
The point opposite to and farthest from the base of a plane figure.

**altitude**  
The perpendicular distance from the base of a geometric figure to the opposite vertex, parallel side, or parallel surface.

**base**  
The line or surface forming the part of a geometric figure that is most nearly horizontal or on which it is supposed to stand, from which an altitude can be constructed.



**triangle**  
A polygon having three sides and three angles.

**isosceles**  
Having two sides of equal length.

**acute**  
Composed only of acute angles.

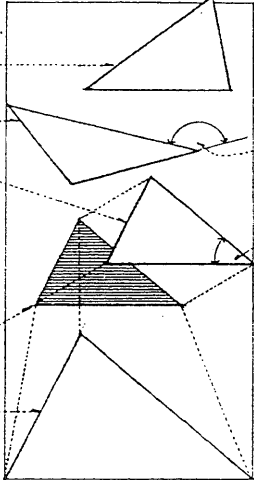
**obtuse**  
Having an obtuse angle.

**scalene**  
Having three unequal sides.

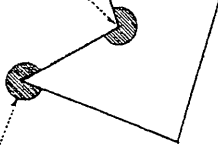
**coincident**  
Occupying the same place in space or time.

**congruent**  
Coinciding at all points when superimposed.

**similar**  
Having corresponding sides proportional and corresponding angles equal.



**reentrant**  
Reentering or pointing inward, as an interior angle of a polygon that is greater than 180°.



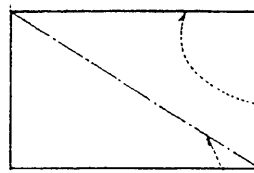
**salient**  
An outward projecting angle or part.

**exterior angle**  
The angle formed between any side of a polygon and an extended adjacent side.

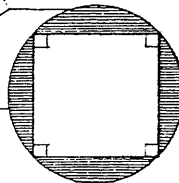
**interior angle**  
The angle formed inside a polygon between any two adjacent sides.

**cant**  
An oblique line or surface, as one formed by cutting off the corner of a square or cube.

**quadrilateral**  
A polygon having four sides and four angles.



**rectangle**  
A parallelogram having four right angles, esp. one with sides of unequal lengths.



**plane geometry**  
The branch of geometry that deals with plane figures.

**plane**  
A surface generated by a straight line moving at a constant velocity with respect to a fixed point, such that a straight line joining any two of its points lies wholly in the surface.

**figure**  
A combination of geometric elements disposed in a particular form or shape.

**polygon**  
A closed plane figure having three or more straight sides.

**rectilinear**  
Forming, formed by, or characterized by straight lines.

**rectangular**  
Having edges, surfaces, or faces that meet at right angles.

**aspect ratio**  
In any rectangular configuration, the ratio of the longer dimension to the shorter.

**diagonal**  
A line connecting two nonadjacent angles or vertices of a polygon or polyhedron.

**square**  
A regular polygon having four equal sides and four right angles.

**trigonometry**  
The branch of mathematics that deals with the properties of triangles and trigonometric functions, and of their applications.

**trigonometric function**  
A function of an angle, as sine or cosine, expressed as the ratio of the sides of a right triangle.

**sine**  
The trigonometric function defined as the ratio of the side opposite a given angle to the hypotenuse.

**cosine**  
The trigonometric function defined as the ratio of the side adjacent to a given angle to the hypotenuse.

**tangent**  
The trigonometric function defined as the ratio of the side opposite a given angle to the side adjacent to the angle.

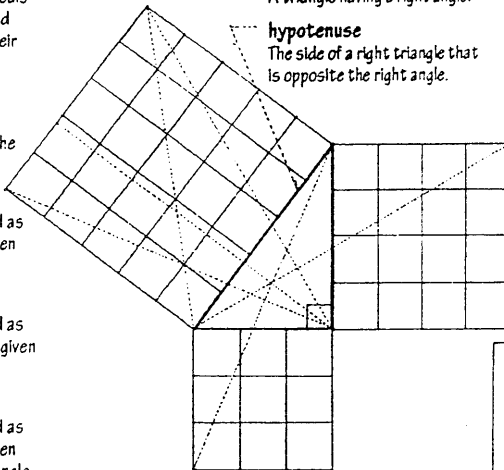
**secant**  
The trigonometric function defined as ratio of the hypotenuse to the side adjacent to a given angle.

**cosecant**  
The trigonometric function defined as the ratio of the hypotenuse to the side opposite a given angle.

**cotangent**  
The trigonometric function defined as the ratio of the side opposite a given angle to the side adjacent to the angle.

**right triangle**  
A triangle having a right angle.

**hypotenuse**  
The side of a right triangle that is opposite the right angle.



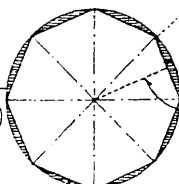
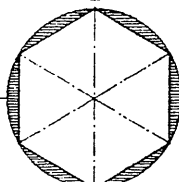
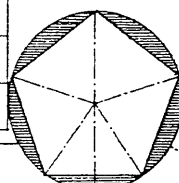
**Pythagorean theorem**  
The theorem that the square of the length of the hypotenuse of a right triangle equals the sum of the squares of the lengths of the other two sides.  
$$c^2 = a^2 + b^2$$

**regular**  
Having all sides equal (equilateral) and all angles equal (equiangular).

**parallelogram**  
A quadrilateral having both pairs of opposite sides parallel to each other.

**trapezoid**  
A quadrilateral having only two sides parallel.

**trapezium**  
A quadrilateral having no two sides parallel.



**pentagon**  
A polygon having five sides and five angles.

**hexagon**  
A polygon having six sides and six angles.

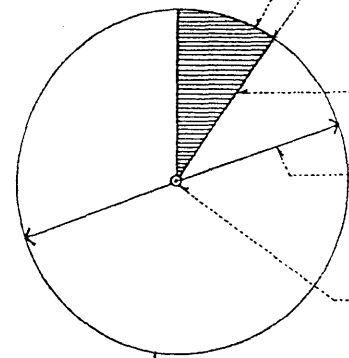
**octagon**  
A polygon having eight sides and eight angles.

**apothem**  
A perpendicular from the center of a regular polygon to one of its sides.

# GEOMETRY

## circle

A closed plane curve every point of which is equidistant from a fixed point within the curve.



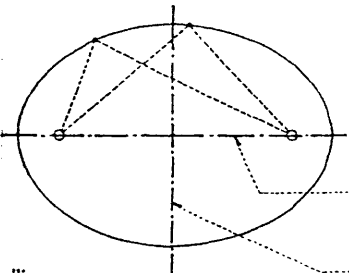
- arc**  
Any part of the circumference of a circle.
- radius**  
A straight line extending from the center of a circle or sphere to the circumference or bounding surface.
- sector**  
A plane figure bounded by two radii and the included arc of a circle.
- diameter**  
A straight line extending through the center of a circle or sphere and meeting the circumference or bounding surface at each end.
- center**  
The point within a circle or sphere equally distant from all points of the circumference or surface, or the point within a regular polygon equally distant from the vertices.

## circumference

The boundary line of a closed curvilinear figure, esp. the perimeter of a circle.

## pi

The symbol  $\pi$  denoting the ratio between the circumference of a circle and its diameter, a constant equal to 3.14159+.

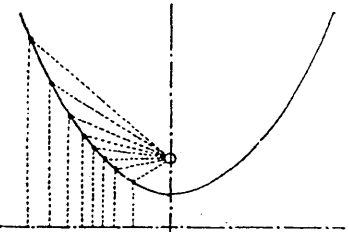


**chord**  
The straight line segment between two points on a given curve.

- major axis**  
The axis passing through the two foci of an ellipse.
- minor axis**  
The axis of an ellipse that is perpendicular to the major axis at a point equidistant from the foci.

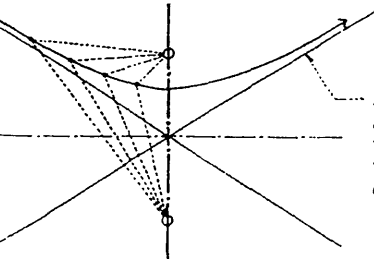
## ellipse

A closed plane curve generated by a point moving in such a way that the sums of its distances from two fixed points, the foci, is a constant.



## parabola

A plane curve generated by a point so moving that it remains equidistant from a fixed line and a fixed point not on the line.



**asymptote**  
A straight line limiting a curve such that the perpendicular distance from the curve to the line approaches zero as the curve is extended to infinity.

## hyperbola

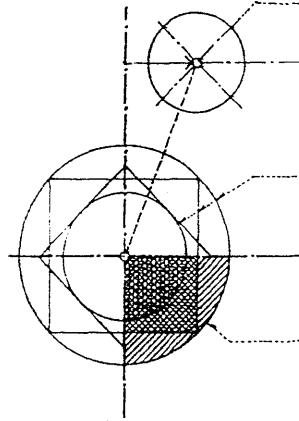
A plane curve generated by a point so moving that the difference of the distances from two fixed points in the plane remains constant.

## eccentric

Not having the same center or center line.

## off-center

Not centered or at the center point.



## concentric

Having a common center, as circles or spheres.

## centerline

An imaginary line that bisects a plane figure.

## quadrant

An arc of 90° or any of the four quarters into which a plane figure is divided by two perpendicular lines, numbered counterclockwise from the upper right.



## curve

A continuously bending line, without angles.

## concave

Curved inward like the interior of a circular arc or hollow sphere.

## inflection

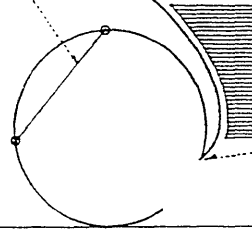
A change of curvature from convex to concave or vice versa.

## convex

Curved or rounded outward like the exterior of a circle or sphere.

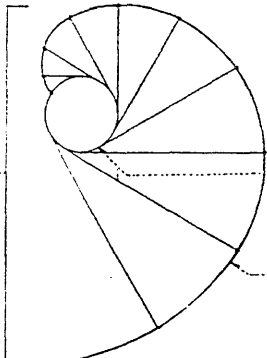
## cusps

A point where two branches of curve meet, end, and are tangent.



## tangent

Touching at a single point, as a straight line in relation to a curve, or in contact along a single line, as a plane with a cylinder.

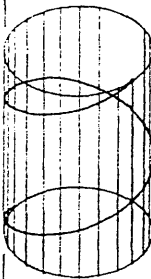


## evolute

The locus of the centers of curvature of, or the envelope of the normals to, another curve.

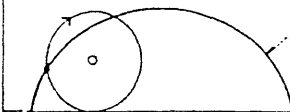
## involute

A curve traced by a point on a string as it is kept taut and unwound from a stationary cylinder.



## helix

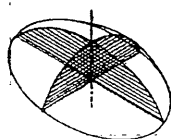
A three-dimensional curve traced on a cylinder or cone by the rotation of a point crossing its right sections at a constant oblique angle.



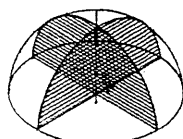
## cycloid

A curve generated by a point on the circumference of a circle as it rolls along a straight line.

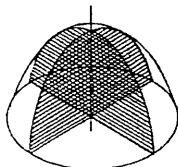
**spheroid**  
A solid geometrical figure similar in shape to a sphere, as an ellipsoid.



**ellipsoid**  
A solid figure all plane sections of which are ellipses.



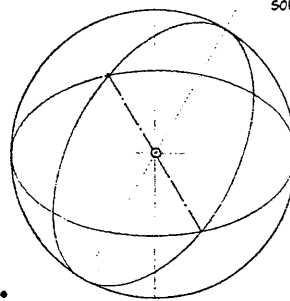
**prolate spheroid**  
A spheroid generated by rotating an ellipse about its major axis.



**oblate spheroid**  
A spheroid generated by rotating an ellipse about its minor axis.

**oblate**  
Flattened at the poles.

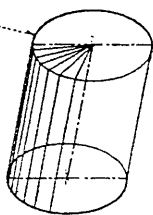
**prolate**  
Elongated along the polar diameter.



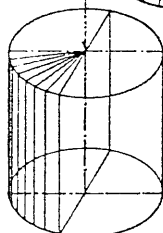
**solid geometry**  
The branch of geometry that deals with solid figures and three-dimensional space.

**sphere**  
A solid generated by the revolution of a semicircle about its diameter, whose surface is at all points equidistant from the center.

**cylinder**  
A solid bounded by two parallel planes and a surface generated by a straight line moving parallel to a fixed straight line and intersecting a closed plane curve in one of the planes.



**right circular cylinder**  
A cylinder generated by a rectangle about one of its sides.



**solid**  
A geometric figure having the three dimensions of length, breadth, and thickness. Also called body.

**volume**  
The extent of a three-dimensional object or the amount of space that it occupies, measured in cubic units.

**surface**  
Any figure having only two dimensions, as a plane or curved two-dimensional locus of points defining the boundary of a solid.

**generator**  
An element that generates a geometric figure, esp. a straight line that generates a surface by moving in a specified fashion. Also called generatrix.

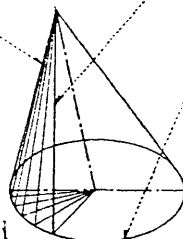
**directrix**  
A fixed line used in the description of a curve or surface.

**center**  
The point within a regular polygon equally distant from the vertices.

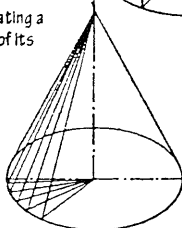
**edge**  
A line at which a surface terminates or at which two surfaces of a solid meet.

**vertex**  
A point in a geometric solid common to three or more sides.

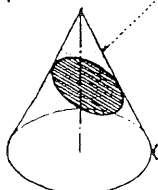
**cone**  
A solid whose surface is generated by a straight line, the generator, passing through a fixed point, the vertex, and moving along the intersection with a closed plane curve, the directrix.



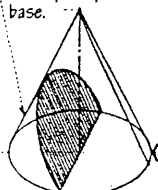
**right circular cone**  
A cone generated by rotating a right triangle about one of its legs.



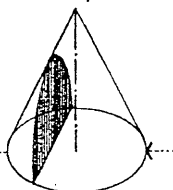
**truncated**  
Having the apex, vertex, or end cut off by a plane, esp. by one parallel to the base.



**frustum**  
The portion of a conical solid left after cutting off the top with a plane parallel to the base.



**conic section**  
A plane curve formed by the intersection of a right circular cone with a plane.



**ellipse**  
A conic section formed by the intersection of a right circular cone with a plane that cuts through both the axis and the surface of the cone.

**parabola**  
A conic section formed by the intersection of a right circular cone with a plane parallel to a generator of the cone.

**hyperbola**  
A conic section formed by the intersection of a right circular cone with a plane that makes a greater angle with the base than does the generator of the cone.

**polyhedron**  
A solid geometric figure bounded by plane faces.

**regular**  
Having all faces congruent regular polygons and all solid angles congruent.

**pyramid**  
A polyhedron having a polygonal base and triangular faces meeting at a common point or vertex.

**tetrahedron**  
A regular polyhedron bounded by four plane faces.

**cube**  
A solid bounded by six equal square sides, the angle between any two adjacent faces being a right angle.

**hexahedron**  
A regular polyhedron having six faces.

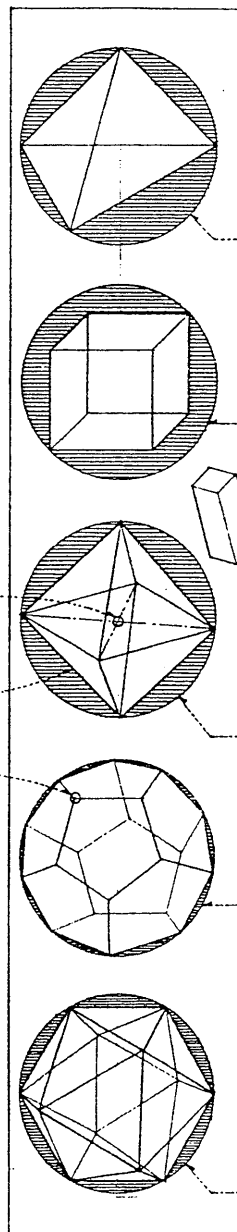
**prism**  
A polyhedron having ends that are parallel, congruent polygons and sides that are parallelograms.

**Platonic solid**  
One of the five regular polyhedrons: tetrahedron, hexahedron, octahedron, dodecahedron, or icosahedron.

**octahedron**  
A regular polyhedron having eight faces.

**dodecahedron**  
A regular polyhedron having 12 faces.

**icosahedron**  
A regular polyhedron having 20 faces.

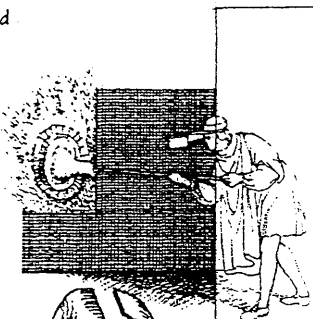


# GLASS

A hard, brittle, usually transparent or translucent substance, produced by fusing silica together with a flux and a stabilizer into a mass that cools to a rigid condition without crystallization.

## **crown glass**

An old form of window glass formed by blowing and whirling a hollow sphere of glass into a flat, circular disk with a center kump left by the worker's rod.



## **sheet glass**

A flat, soda-lime-silica glass fabricated by drawing the molten glass from a furnace (drawn glass), or by forming a cylinder, dividing it lengthwise, and flattening it (cylinder glass). The fire-polished surfaces are not perfectly parallel, resulting in some distortion of vision.



## **single-strength glass**

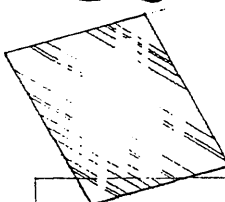
Sheet glass having a thickness of 3/32 in. (2.4 mm).

## **double-strength glass**

Sheet glass having a thickness of 1/8 in. (3.2 mm).

## **plate glass**

A flat, soda-lime-silica glass formed by rolling molten glass into a plate (rolled glass) that is subsequently ground and polished after cooling.



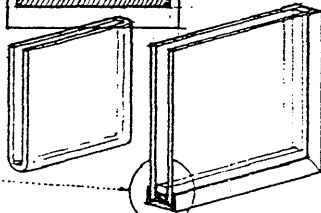
## **float glass**

A flat, soda-lime-silica glass that is extremely smooth and nearly distortion-free, manufactured by pouring molten glass onto a surface of molten tin and allowing it to cool slowly. Float glass is the successor to plate glass and accounts for the majority of flat-glass production.



## **insulating glass**

A glass unit consisting of two or more sheets of glass separated by hermetically-sealed airspaces.

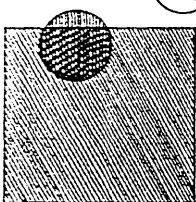


## **hermetic**

Made airtight by fusing or sealing.

## **tinted glass**

Glass having a chemical admixture to absorb a portion of the radiant heat and visible light that strike it. Iron oxide gives the glass a pale blue-green tint; cobalt oxide and nickel imparts a grayish tint; selenium infuses a bronze tint. Also called heat-absorbing glass.



## **reflective glass**

Glass having a thin, translucent metallic coating bonded to the exterior or interior surface to reflect a portion of the light and radiant heat that strike it.

## **low-emissivity glass**

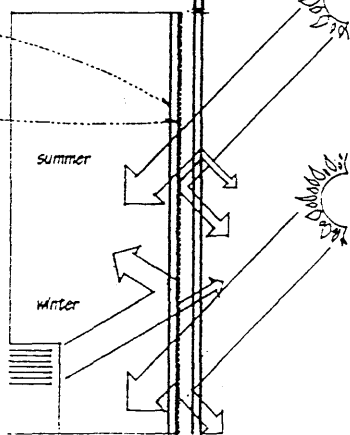
Glass that transmits visible light while selectively reflecting the longer wavelengths of radiant heat, produced by depositing a low-emissivity coating either on the glass itself or over a transparent plastic film suspended in the sealed air space of insulating glass. Also called low-e glass.

## **emissivity**

The relative ability of a surface to emit radiant heat, measured against a black body at the same temperature.

## **shading coefficient**

The ratio of solar heat transmission through a particular glass to the solar heat transmission through double-strength clear glass.



## **annealed glass**

Glass that is cooled slowly to relieve internal stresses.

## **heat-strengthened glass**

Annealed glass that is partially tempered by a process of reheating and sudden cooling. Heat-strengthened glass has about twice the strength of annealed glass of the same thickness.

## **tempered glass**

Annealed glass that is reheated to just below the softening point and then rapidly cooled to induce compressive stresses in the surfaces and edges of the glass and tensile stresses in the interior. Tempered glass has three to five times the resistance of annealed glass to impact and thermal stresses but cannot be altered after fabrication. When fractured, it breaks into relatively harmless particles.

## **laminated glass**

Two or more plies of flat glass bonded under heat and pressure to interlayers of polyvinyl butyral resin that retains the fragments if the glass is broken. Also called safety glass.

## **security glass**

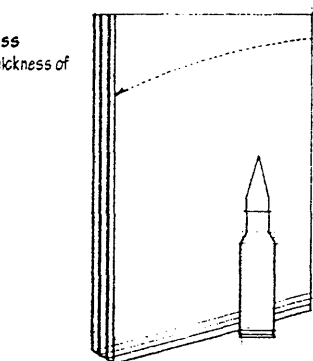
Laminated glass having exceptional tensile and impact strength, consisting of multiple plies of glass bonded under heat and pressure to interlayers of polyvinyl butyral resin.

## **acoustical glass**

Laminated or insulating glass used for sound control.

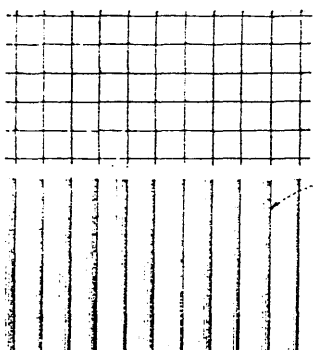
## **wire glass**

Flat or patterned glass having a square or diamond wire mesh embedded within it to prevent shattering in the event of breakage or excessive heat. Wire glass is considered a safety glazing material.



## **patterned glass**

Glass having an irregular surface pattern formed in the rolling process to obscure vision or to diffuse light. Also called figured glass.

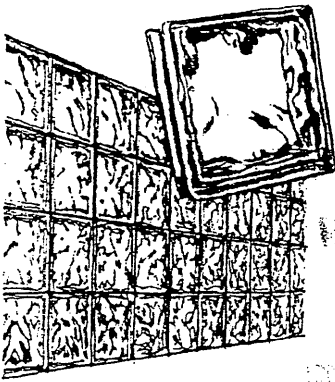


## **obscure glass**

Glass having one or both sides acid-etched or sandblasted to obscure vision.

## **spandrel glass**

An opaque glass for concealing the structural elements in curtain wall construction, produced by fusing a ceramic frit to the interior surface of tempered or heat-strengthened glass.



## **glass block**

A translucent, hollow block of glass with clear, textured, or patterned faces, made by fusing two halves together with a partial vacuum inside and used for glazing openings.

## **glass brick**

A solid, impact-resistant glass block unit, sometimes having an insert or coated to reduce solar heat transmission.



**face glazing**

The setting of a glass pane in a rabbeted frame, holding it in place with glazier's points, and sealing it with a beveled bead of putty or glazing compound.

**face putty**

The putty or glazing compound formed on the exterior side of a glass pane.

**bedding**

A thin layer of putty or glazing compound laid in the rabbet of a window sash to give a pane of glass an even backing.

**glazier's point**

A small, pointed piece of sheet metal for holding a glass pane in a wood sash until the face putty has hardened. Also called glazing brad, sprig.

**putty**

A compound of whiting and linseed oil, of doughlike consistency when fresh, used in securing windowpanes or patching woodwork defects.

**glazing compound**

An adhesive compound used as putty, formulated so as not to become brittle with age.

**glass size**

The size of a glass pane or unit required for glazing an opening, allowing for adequate edge clearances. Also called glazing size.

**united inches**

The sum of one length and one width of a rectangular glass pane or unit, measured in inches.

**edge block**

One of the small blocks of synthetic rubber placed between the side edges of a glass pane or unit and a frame to center it, maintain a uniform width of sealant, and limit lateral movement caused by building vibrations or thermal expansion or contraction. Also called centering shim, spacer.

**face clearance**

The distance between the face of a glass pane or unit and the nearest face of its frame or stop, measured normal to the plane of the glass.

**bite**

The amount of overlap between the edge of a glass pane or unit and a window frame, stop, or lock-strip gasket.

**edge clearance**

The distance between the edge of a glass pane or unit and a window frame, measured in the plane of the glass.

**glass mullion system**

A glazing system in which sheets of tempered glass are suspended from special clamps, stabilized by perpendicular stiffeners of tempered glass, and joined by a structural silicone sealant and sometimes by metal patch plates.

**double glazing**

The installation of two parallel panes of glass with a sealed air space between to reduce the transmission of heat and sound.

**glazing**

The panes or sheets of glass or other transparent material made to be set in frames, as in windows, doors, or mirrors.

**wet glazing**

The setting of glass in a window frame with glazing tape or a liquid sealant.

**glazing tape**

A preformed ribbon of synthetic rubber having adhesive properties and used in glazing to form a watertight seal between glass and frame.

**cap sealant**

An adhesive liquid of synthetic rubber injected into the joint between a glass pane or unit and a window frame, curing to form a watertight seal. Also called cap bead.

**glazing bead**

A wood molding or metal section secured against the edge of a glass pane or unit to hold it in place. Also called glazing stop.

**heel bead**

An adhesive liquid of synthetic rubber injected between a glass pane or unit and a glazing bead, curing to form an airtight seal.

**dry glazing**

The setting of glass in a window frame with a compression gasket instead of glazing tape or a liquid sealant.

**compression gasket**

A preformed strip of synthetic rubber or plastic compressed between a glass pane or unit and a window frame to form a watertight seal and cushion for the glass.

**lockstrip gasket**

A preformed gasket of synthetic rubber for securing a glass pane or unit in a window frame or opening, held in compression by forcing a keyed locking strip into a groove in the gasket.

**flush glazing**

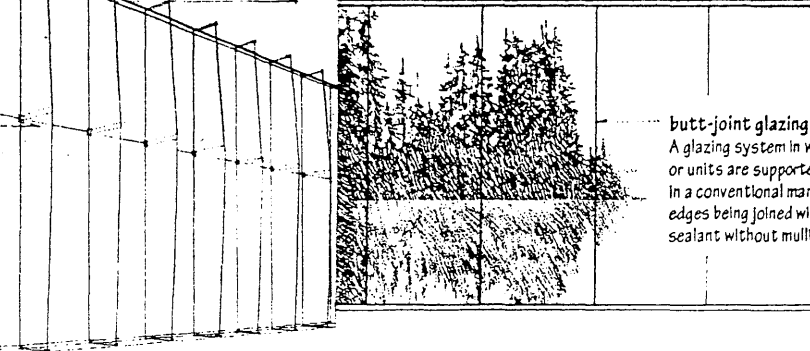
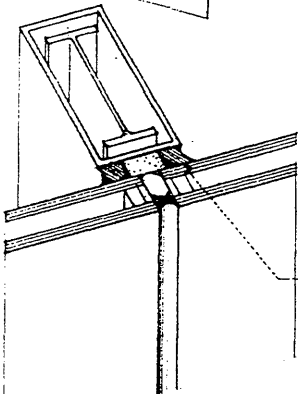
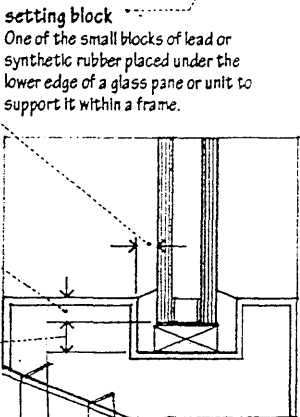
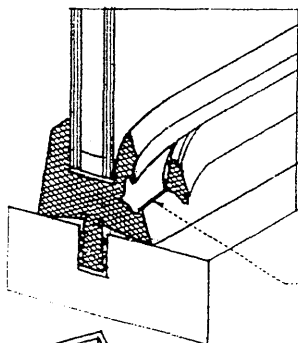
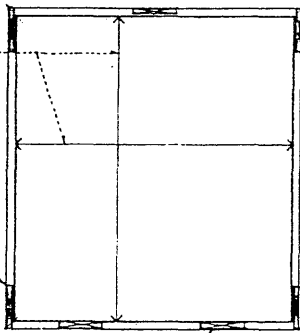
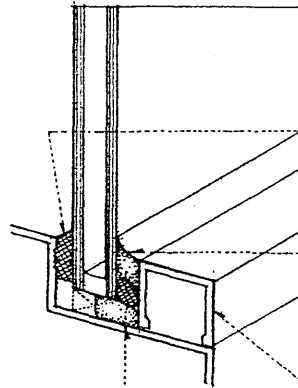
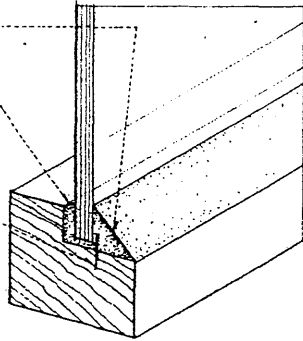
A glazing system in which the framing members are set entirely behind the glass panes or units to form a flush exterior surface, the glass adhering to the framing with a structural silicone sealant.

**structural sealant**

A high-strength silicone sealant capable of adhering glass to a supporting frame.

**butt-joint glazing**

A glazing system in which the glass panes or units are supported at the head and sill in a conventional manner, with their vertical edges being joined with a structural silicone sealant without mullions.



# HARDWARE

The metal tools, fastenings, and fittings used in construction.

## rough hardware

Bolts, screws, nails, and other metal fittings that are concealed in a finished construction.

## finish hardware

Exposed hardware serving a decorative as well as a utilitarian purpose, as the locks, hinges, and other accessories for doors, windows, and cabinetwork. Also called architectural hardware.

## door hardware

The finish hardware required for hanging and operating a door.

## door closer

A hydraulic or pneumatic device for controlling the closing of a door and preventing it from slamming. Also called door check.

## overhead concealed closer

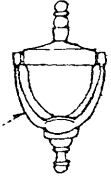
A door closer concealed in the head of a doorframe.

## backcheck

A device in a hydraulic door closer for slowing the speed with which a door may be opened.

## knocker

A hinged ring, bar, or knob on a door for use in knocking.



## doorplate

A small identifying plate on the outside door of a house or room, bearing the occupant's name, the house or apartment number, or the like.

## judas

A peephole, as in an entrance door or the door of a prison cell. Also called judas hole.

## door chain

A short chain with a removable slide fitting that can be attached between the inside of a door and the doorjamb to prevent the door from being opened more than a few inches without the chain being removed.

## mail slot

A small opening in an exterior door or wall, often with a hinged closer, through which mail is delivered. Also called letter slot.

## doorstop

A device for holding a door open, as a wedge or small weight.

## bumper

A projecting rim, guard, pad, or disk for absorbing shock or preventing damage from bumping.

## push plate

A protective plate of metal or plastic mounted vertically on the lock stile of a door.

## door pull

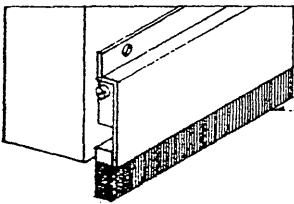
A handle for opening a door.

## pull bar

A bar fixed across a glazed door, used for opening or closing the door and providing protection for the glass.

## kick plate

A protective metal plate fastened to the bottom of a door to resist blows and scratches.



## floor closer

A door closer installed in a recess in the floor.

## automatic door bottom

A horizontal bar at the bottom of a door that drops automatically when the door is closed in order to seal the threshold and reduce noise transmission.

## hand

The position of the hinges of a door, in terms of right and left, when seen from the exterior of the building or room to which the doorway leads.

## left-hand

Having the hinges on the left of an inward opening door when seen from the exterior of the building or room to which the doorway leads.

## right-hand

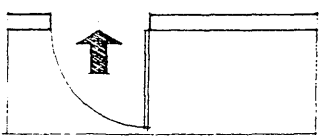
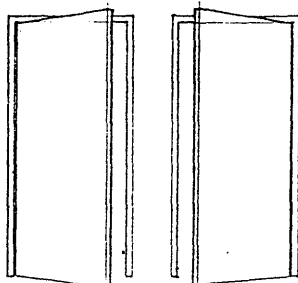
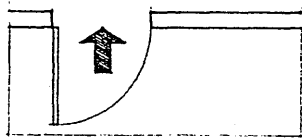
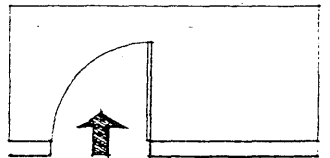
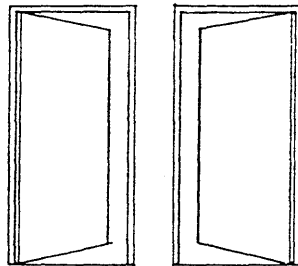
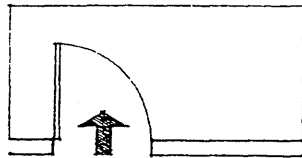
Having the hinges on the right of an inward opening door when seen from the exterior of the building or room to which the doorway leads.

## left-hand reverse

Having the hinges on the left of an outward opening door when seen from the exterior of the building or room to which the doorway leads.

## right-hand reverse

Having the hinges on the right of an outward opening door when seen from the exterior of the building or room to which the doorway leads.



**mortise hinge**

A butt hinge mortised into the abutting surfaces of a door and doorjamb.

**half-mortise hinge**

A hinge having one leaf mortised into the edge of the door and the other surface-mounted on the doorframe.

**half-surface hinge**

A hinge having one leaf mortised into the doorframe and the other surface-mounted on the face of the door.

**flap hinge**

A hinge having two leaves surface-mounted to the adjacent faces of a door and doorframe. Also called backflap hinge, full-surface hinge.

**template hinge**

A mortise hinge manufactured to fit the recess and match the arrangement of holes of hollow metal doors and frames.

**ball-bearing hinge**

A hinge equipped with ball bearings between the knuckles to reduce friction and ensure ease of operation.

**fast-pin hinge**

A hinge having a nonremovable pin.

**loose-pin hinge**

A hinge having a removable pin so that a door can be unhung by separating the two leaves.

**loose-joint hinge**

A hinge having a knuckle formed from half of each leaf, with the upper half removable from the pin. Also called liftoff hinge.

**pin**

A pin or bolt on which something turns, as the gudgeon of a hinge.

**gudgeon**

A socket for the pin of a hinge.

**spring hinge**

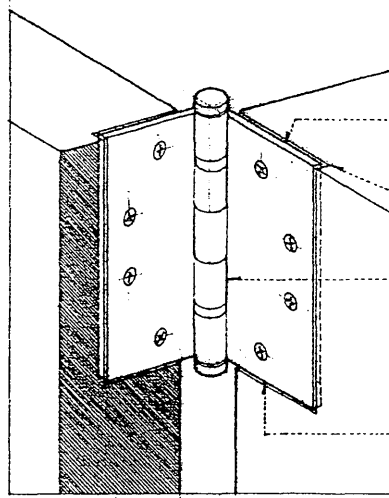
A hinge containing a coiled spring in its barrel for closing a door automatically.

**double-acting hinge**

A hinge permitting a door to swing in either direction, usually fitted with springs to bring the door to a closed position after opening.

**piano hinge**

A long, narrow hinge that runs the full length of the two surfaces to which its leaves are joined. Also called continuous hinge.



**hinge**

A jointed device, usually consisting of two leaves joined together by a pin, on which a door, gate, or shutter swings, turns, or moves.

**leaf**

A hinged, sliding, or otherwise movable part of a door, hinge, or tabletop.

**gain**

A notch cut into a surface to receive a leaf of a hinge. Also called sinking.

**knuckle**

The cylindrical, projecting joint of a hinge through which the pin passes.

**butt hinge**

A hinge composed of two plates secured to the abutting surfaces of a door and doorjamb. Also called butt.

**strap hinge**

A hinge having two long leaves for securing to the adjacent faces of a door and doorjamb.

**cross-garnet**

A T-shaped strap hinge with the crosspiece as the stationary member and the long stem being the movable leaf. Also called T-hinge.

**dovetail hinge**

A strap hinge having leaves which are narrower at their junction than at their other extremities.

**parliament hinge**

An H-shaped hinge having a protruding knuckle so that a door can stand away from the wall when fully opened.

**paumelle**

A hinge having a single, pivoting joint.

**olive knuckle hinge**

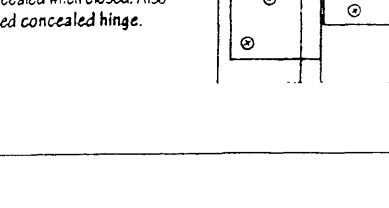
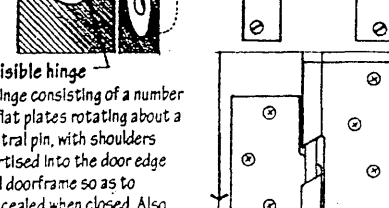
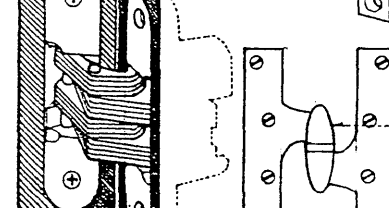
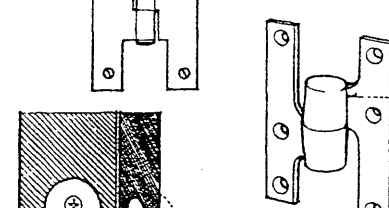
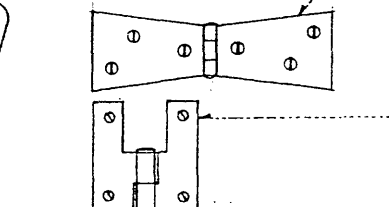
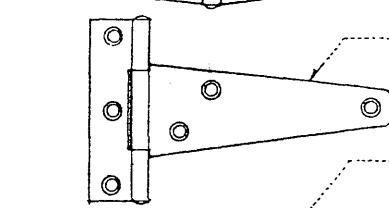
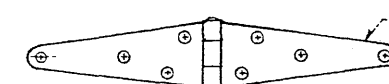
A paumelle having an oval-shaped knuckle. Also called olive hinge.

**gravity hinge**

A hinge that closes automatically by means of gravity.

**rising hinge**

A gravity hinge causing a door to rise slightly when opened.



**invisible hinge**

A hinge consisting of a number of flat plates rotating about a central pin, with shoulders mortised into the door edge and doorframe so as to be concealed when closed. Also called concealed hinge.

# HARDWARE

**lock**

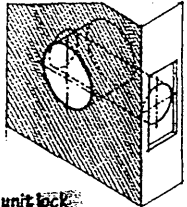
A device for securing a door, drawer, or lid in position when closed, consisting of a bolt or combination of bolts propelled and withdrawn by a key- or combination-operated mechanism.

**rim lock**

A lock fastened to the face of a door, as opposed to one built into its edge.

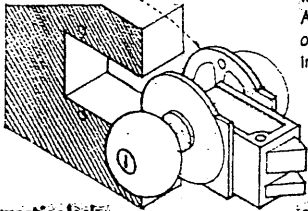
**cylinder lock**

A lock housed within two holes bored at right angles to each other, one through the face of a door and the other in the door edge.



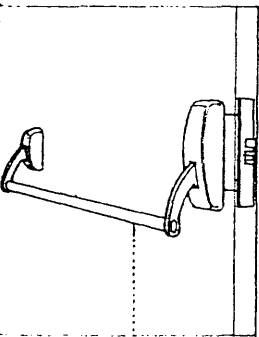
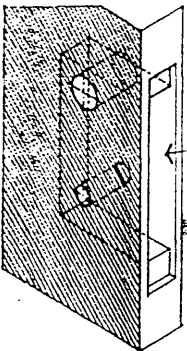
**unit lock**

A lock housed within a rectangular notch cut into the edge of a door.



**mortise lock**

A lock housed within a mortise cut into a door edge so that the lock mechanism is covered on both sides.

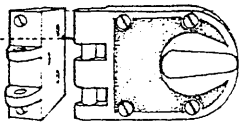


**panic bar**

A horizontal bar that spans the interior of an emergency exit door at waist height and that opens the latch when pressure is applied. Also called panic bolt, panic hardware.

**lockset**

An assembly of parts making up a complete locking system, including knobs, plates and a locking mechanism.



**doornob**

The knob-shaped handle by which a door is opened or closed.

**keyhole**

A hole in a lock case or escutcheon for inserting a key.

**rose**

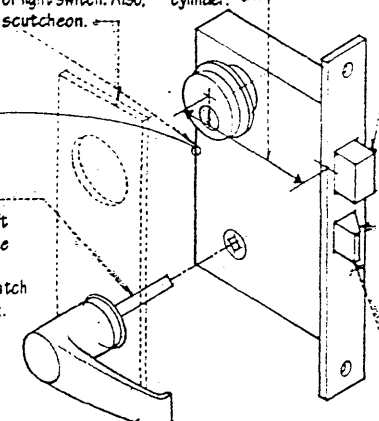
An ornamental plate surrounding the shaft of a doornob at the face of a door.

**escutcheon**

A protective or ornamental plate, as around a keyhole, doornob, drawer pull, or light switch. Also, scutcheon.

**backset**

The horizontal distance from the face of a lock through which the bolt passes to the centerline of the knob stem, keyhole, or lock cylinder.



**lever handle**

A horizontal handle for operating the bolt of a lock.

**strike**

A metal plate on a doorjamb having a hole for receiving the end of a lock bolt when the door is closed. Also called strike plate.

**lip**

The projecting edge or rim of a strike.

**box strike**

A metal box recessed into a doorjamb to receive the end of a lock bolt when the door is closed.

**latch**

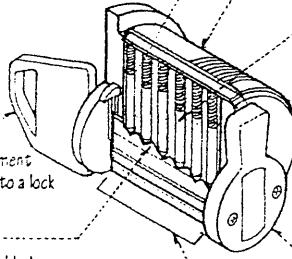
A device for holding a door closed, consisting essentially of a bar that falls or slides into a groove or hole.

**key**

A small metal instrument specially cut to fit into a lock and move its bolt.

**bit**

One of the projecting blades cut to engage with and actuate either or both the bolt and the tumblers of a lock.



**cylinder**

A cylindrical device for retaining the bolt of a lock until the tumblers have been pushed out of its way.

**tumbler**

An obstructing part in a lock that prevents a bolt from being propelled or withdrawn until it is moved by the action of a key.

**lever tumbler**

A flat metal tumbler having a pivoting motion actuated by the turning of a key.

**cam**

A disk or cylinder having an irregular form that rotates or slides to impart motion to a roller moving against its edge or to a pin free to move in a groove on its face.

**keyway**

A slot in a lock for receiving and guiding a key.

**ward**

A projecting ridge of metal in a lock or keyhole that prevents the insertion of any key that does not have a corresponding notch.

**faceplate**

The edge plate or surface through which the bolt of a lock passes. Also called ~~selvage~~.

**bolt**

A metal bar or rod in the mechanism of a lock that is propelled or withdrawn, as by turning a knob or key.

**deadbolt**

A lock bolt having a square head that is moved into position by the turning of a knob or key rather than by spring action. Also called ~~deadlock~~.

**bevel**

The oblique end of a latchbolt that hits a strike plate.

**reversible lock**

A lock having a latchbolt that can be reversed for installation in either a right-hand or left-hand door.

**bevel**

The side of a lock facing in the same direction as the bevel at the end of the latchbolt.

**regular bevel**

The bevel of a bolt or lock on a door opening into the building or room to which the doorway leads.

**reverse bevel**

The bevel of a bolt or lock on a door opening outward from the building or room to which the doorway leads.

**latchbolt**

A lock bolt having a beveled head that is moved into position by a spring except when retracted by a doornob, or when pushed against the lip of the strike plate as the door is closed.

**flush bolt**

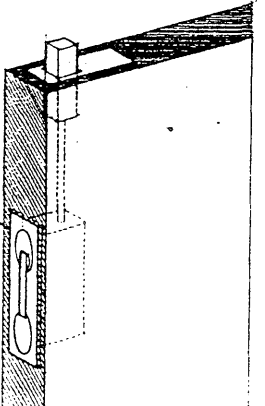
A bolt set flush with the face or edge of a door.

**extension bolt**

A flush bolt fitted into a mortise in a door, sliding into a socket in the head or the sill.

**coordinator**

A device for ensuring that the inactive leaf of a pair of doors is permitted to close before the active leaf.



**temperature**

A measure of the warmth or coldness of a substance, object, or environment with reference to some standard value.

**thermometer**

An instrument for measuring temperature, consisting typically of a glass tube with a numbered scale and a bulb containing a liquid, as mercury, that rises and falls with changes in temperature.

**British thermal unit**

The quantity of heat required to raise the temperature of one pound (0.4 kg) of water 1°F. Abbr.: Btu

**therm**

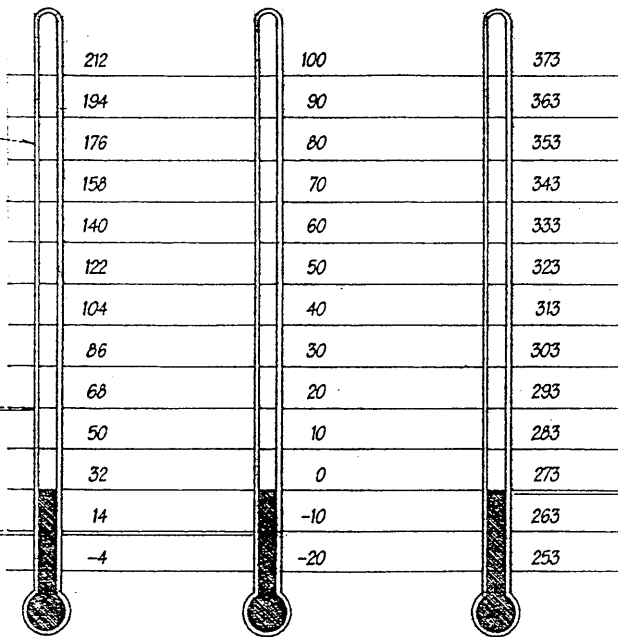
A unit of heat equal to 100,000 British thermal units.

**calorie**

A unit of heat equal to the quantity of heat required to raise the temperature of one gram of water 1°C at a pressure of one atmosphere, equivalent to 4.186 joules. Abbr.: cal. Also called gram calorie, small calorie.

**kilocalorie**

A unit of heat equal to the quantity of heat required to raise the temperature of one kilogram of water 1°C at a pressure of one atmosphere, equivalent to 1000 small calories. Abbr.: Cal. Also called kilogram calorie, large calorie.



**Fahrenheit scale**

A temperature scale in which 32°F represents the freezing point and 212°F the boiling point of water under standard atmospheric pressure.

**Celsius scale**

A temperature scale divided into 100 degrees, in which 0°C represents the freezing point and 100°C the boiling point of water under standard atmospheric pressure. Also called Centigrade scale.

**Kelvin scale**

An absolute scale of temperature having a zero point of -273.16°C.

**absolute scale**

A temperature scale based on absolute zero with scale units equal in magnitude to centigrade degrees.

**absolute zero**

The hypothetical lowest limit of physical temperature characterized by complete absence of heat, equal to -273.16°C or -459.67°F.

**absolute temperature**

Temperature as measured on a absolute scale.

A form of energy associated with the random motion of atoms or molecules, capable of being transmitted by convection, conduction, or radiation and causing substances to rise in temperature, fuse, expand, or evaporate.

**kelvin**

The base SI unit of temperature equal to 1/273.16 of the triple point of water. Symbol: K

**triple point**

The particular temperature and pressure at which the liquid, gaseous, and solid phases of a substance can exist in equilibrium.

*When you know degrees Fahrenheit, first subtract 32 and then multiply by 5/9 to find degrees Celsius.*

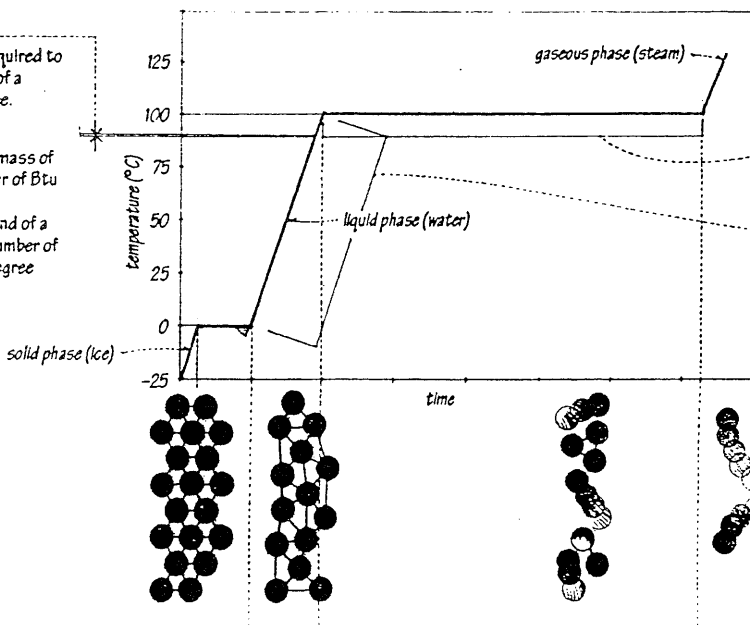
*When you know degrees Celsius, first multiply by 9/5 and then add 32 to find degrees Fahrenheit.*

**heat capacity**

The quantity of heat required to raise the temperature of a substance by one degree.

**specific heat**

Heat capacity per unit mass of a substance; the number of Btu required to raise the temperature of one pound of a substance 1°F, or the number of calories per gram per degree centigrade.



**latent heat**

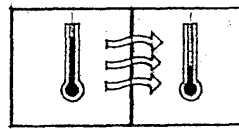
The quantity of heat absorbed or released by a substance during a change in phase at constant temperature and pressure.

**sensible heat**

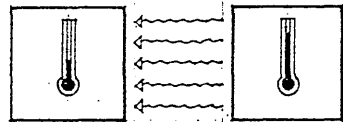
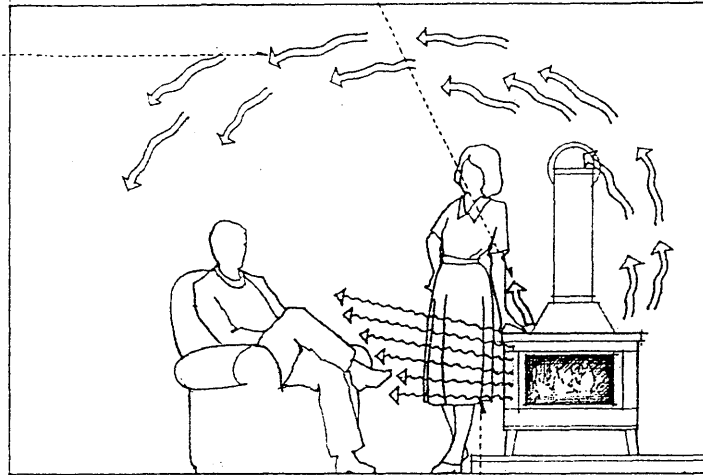
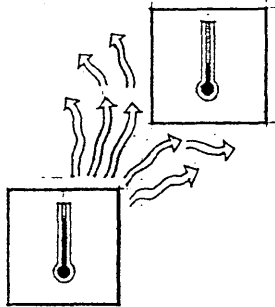
The quantity of heat absorbed or released by a substance during a change in temperature without a change in phase.

# HEAT

**conduction**  
The transfer of heat from the warmer to the cooler particles of a medium or of two bodies in direct contact, occurring without perceptible displacement of the particles themselves.



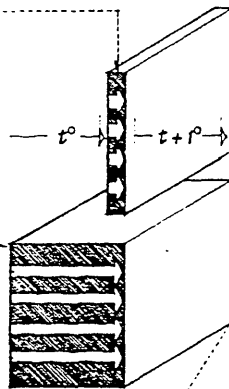
**convection**  
The transfer of heat by the circulatory motion of the heated parts of a liquid or gas owing to a variation in density and the action of gravity.



**radiation**  
The process in which energy in the form of waves or particles is emitted by one body, passed through an intervening medium or space, and absorbed by another body.

**thermal conductivity**  
The time rate of heat flow through a unit area of a given material of unit thickness when the temperature difference across the thickness is one unit of temperature.

**thermal conductance**  
The time rate of heat flow through a unit area of a given material when the temperature difference across a specified thickness of the material is one unit of temperature.



**thermal resistance**  
The reciprocal of thermal conductance, expressed as the temperature difference required to cause heat to flow through a unit area of a material of given thickness at the rate of one heat unit per unit time.

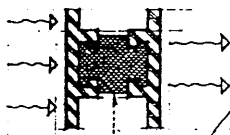
**R-value**  
A measure of thermal resistance of a given material, used esp. to specify the performance of thermal insulation. The total R-value for a building component or assembly is the sum of the R-values for each layer in the component or assembly.

**thermal transmittance**  
The time rate of heat flow through a unit area of a building component or assembly when the difference between the air temperatures on the two sides of the component or assembly is one unit of temperature. Also called coefficient of heat transfer.

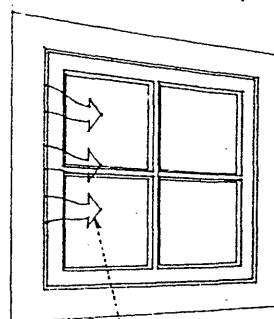
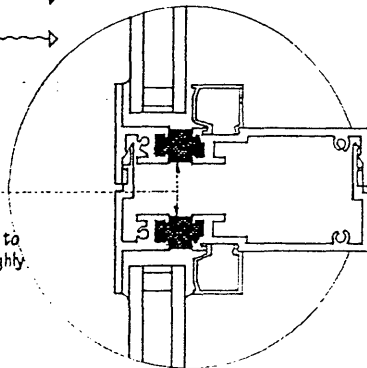
**U-value**  
A measure of the thermal transmittance of a building component or assembly, equal to the reciprocal of the total R-value of the component or assembly.

$$C = 1/R$$

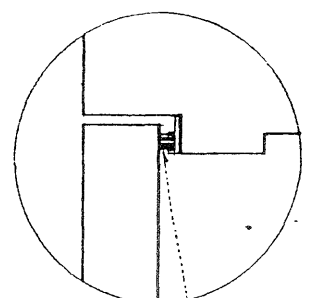
$$1/R(\text{total}) = U$$



**thermal break**  
An element of low thermal conductivity placed in an assembly to reduce the flow of heat between highly conductive materials. Also called thermal barrier.



**infiltration**  
The flow of outside air into an interior space through cracks around windows and doors or other openings in the envelope of a building.



**weather strip**  
A strip of metal, felt, vinyl, or foam rubber, placed between a door or window sash and its frame to provide a seal against windblown rain and air infiltration. Also, weather stripping.

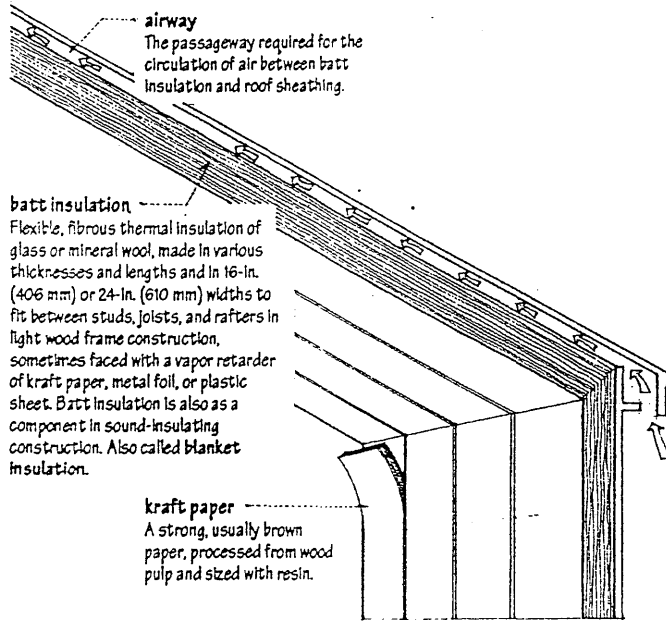
**mineral wool**  
Any of various lightweight, inorganic, fibrous materials used esp. for thermal and sound insulation, as glass wool and rock wool.

**glass wool**  
Spun glass fibers resembling wool and used for thermal insulation and air filters.

**fiberglass**  
A material consisting of extremely fine filaments of glass, woven into fabric, massed for use as a thermal and acoustical insulator, or embedded to reinforce various materials.

**Fiberglas**  
Trademark for a brand of fiberglass.

**rock wool**  
Mineral wool made by blowing steam or air through molten slag or rock.



**thermal insulation**  
A material providing high resistance to heat flow, as mineral wool, vermiculite, or foamed plastic, fabricated in the form of batts, blankets, boards, or loose fill.

**weatherize**  
To make a house or building secure against cold or stormy weather, as by adding thermal insulation or storm windows, or by sealing joints.

**foamed plastic**  
Plastic, as polyurethane or polystyrene, made light and cellular by the introduction of pockets of gas or air and used as thermal insulation. Also called expanded plastic, plastic foam.

**polyurethane foam**  
A rigid expanded polyurethane having a closed-cell structure and used as thermal insulation.

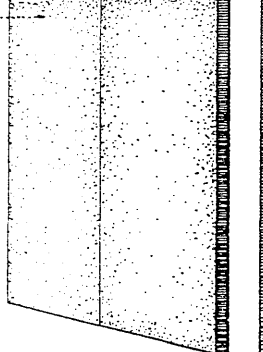
**molded polystyrene**  
A rigid polystyrene foam having an open-cell structure and used as thermal insulation.

**extruded polystyrene**  
A rigid polystyrene foam having a closed-cell structure and used as thermal insulation.

**Styrofoam**  
Trademark for a brand of foamed plastic made from polystyrene.

**foam glass**  
Cellular glass made by foaming softened glass and molding it into boards or blocks for use as thermal insulation.

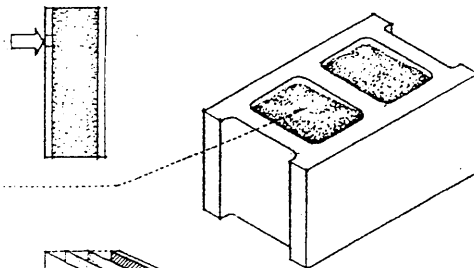
**rigid board insulation**  
A preformed, nonstructural insulating board of foamed plastic or cellular glass. Cellular glass insulation is fire-resistant, impervious to moisture, and dimensionally stable, but has a lower thermal-resistance value than foamed plastic insulations, which are flammable and must be protected by a thermal barrier when used on the interior surfaces of a building. Rigid insulation having closed-cell structures, as extruded polystyrene and cellular glass, are moisture-resistant and may be used in contact with the earth.



**fiberboard**  
An insulating board made of wood or cane fibers compressed and cemented into rigid sheets, used as an inexpensive wall finish or as ceiling tiles.

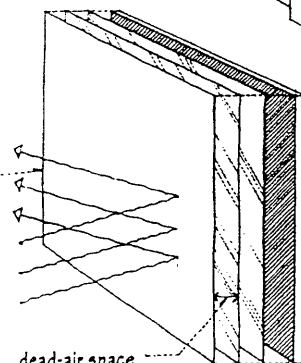
**fiberboard sheathing**  
Insulating fiberboard treated or impregnated with asphalt for water resistance and used primarily for sheathing light wood frame walls.

**foamed-in-place insulation**  
Thermal insulation in the form of a foamed plastic, as polyurethane, that is sprayed or injected into a cavity where it adheres to the surrounding surfaces.



**loose-fill insulation**  
Thermal insulation in the form of mineral wool fibers, granular vermiculite or perlite, or treated cellulosic fibers, poured by hand or blown through a nozzle into a cavity or over a supporting membrane.

**reflective insulation**  
Thermal insulation in the form of a material of high reflectivity and low emissivity, as paper-backed aluminum foil or foil-backed gypsum board, used in conjunction with a dead-air space to reduce the transfer of heat by radiation.



**emissivity**  
The ability of a surface to emit heat by radiation, equal to the ratio of the radiant energy emitted to that emitted by a black body at the same temperature.

**wood wool**  
Fine wood shavings, usually of pine or chemically treated wood fibers, used as an insulating material, as a binder in plaster, and for packing. Also called excelsior.

# HEAT

## thermal comfort

Human comfort as determined by the ability of the body to dissipate the heat and moisture it produces by metabolic action.

### effective temperature

A temperature representing the combined effect of ambient temperature, relative humidity, and air movement on the sensation of warmth or cold felt by the human body, equivalent to the dry-bulb temperature of still air at 50% relative humidity which induces an identical sensation.

**wet-bulb temperature**  
The temperature recorded by the wet-bulb thermometer in a psychrometer.

**dew point**  
The temperature at which air becomes saturated with water vapor. Also called dew-point temperature.

**comfort zone**  
The range of dry-bulb temperature, relative humidity, mean radiant temperature, and air movement judged to be comfortable by a majority of Americans and Canadians tested. This comfort zone varies with climate, the season of the year, the type of clothing worn, and the activity level of the individual. Also called comfort envelope.

**psychrometric chart**  
A chart relating the wet-bulb and dry-bulb readings from a psychrometer to relative humidity, absolute humidity, and dew point.

**dry-bulb temperature**  
The temperature recorded by the dry-bulb thermometer in a psychrometer.

**psychrometer**  
An instrument for measuring atmospheric humidity, consisting of two thermometers, the bulb of one being dry and the bulb of the other being kept moist and ventilated so that the cooling that results from evaporation makes it register a lower temperature than the dry one, with the difference between the readings being a measure of atmospheric humidity.

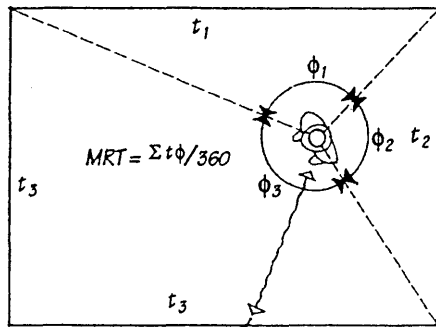
**relative humidity**  
The ratio of the amount of water vapor actually present in the air to the maximum amount that the air could hold at the same temperature, expressed as a percentage. Abbr.: rh

**absolute humidity**  
The mass of water vapor present in a unit volume of air.

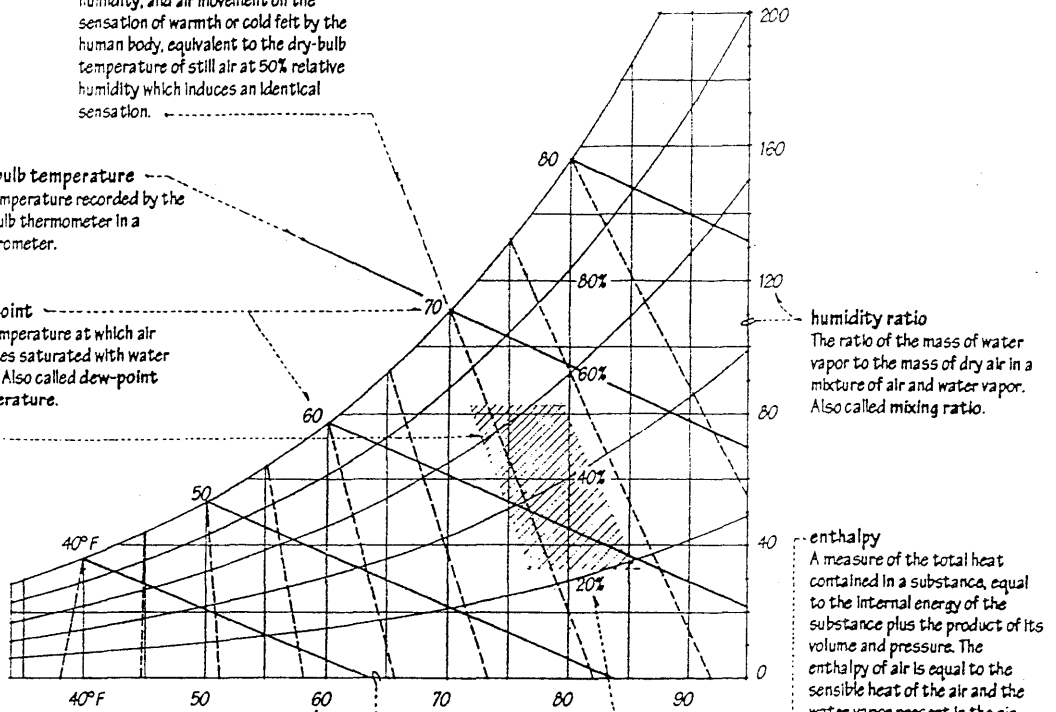
**specific humidity**  
The ratio of the mass of water vapor in air to the total mass of the mixture of air and water vapor.

**hygrometer**  
Any of various instruments for measuring the humidity of the atmosphere.

**mean radiant temperature**  
The sum of the temperatures of the surrounding walls, floor, and ceiling of a room, weighted according to the solid angle subtended by each at the point of measurement. Mean radiant temperature is important to thermal comfort since the human body receives radiant heat from or loses heat by radiation to the surrounding surfaces if their mean radiant temperature is significantly higher or lower than the air temperature.

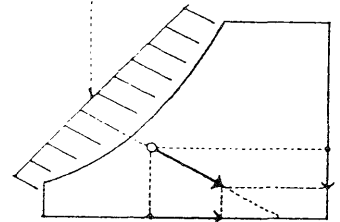


**radiant heat**  
Heat energy transmitted by the radiation of electromagnetic waves in contrast to heat transmitted by conduction or convection.

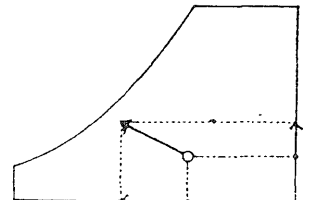


**humidity ratio**  
The ratio of the mass of water vapor to the mass of dry air in a mixture of air and water vapor. Also called mixing ratio.

**enthalpy**  
A measure of the total heat contained in a substance, equal to the internal energy of the substance plus the product of its volume and pressure. The enthalpy of air is equal to the sensible heat of the air and the water vapor present in the air plus the latent heat of the water vapor, expressed in Btu per pound (kilojoules per kilogram) of dry air. Also called heat content.



**adiabatic heating**  
A rise in temperature occurring without the addition or removal of heat, as when excess water vapor in the air condenses and the latent heat of vaporization of the water vapor is converted to sensible heat in the air.

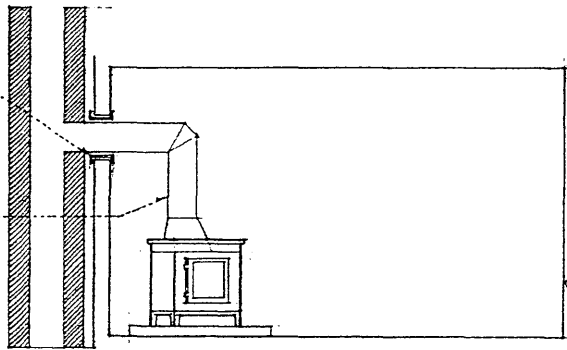


**evaporative cooling**  
A drop in temperature occurring without the addition or removal of heat, as when water evaporates and the sensible heat of the liquid is converted to latent heat in the vapor. Also called adiabatic cooling.



**thimble**  
A protective sleeve of sheet metal passing through the wall of a chimney, for holding the end of a stovepipe.

**stovepipe**  
A pipe, usually of sheet metal, serving as a stove chimney or connecting a stove with a chimney flue.



**Franklin stove**  
A cast-iron stove resembling an open fireplace but having enclosed sides, back, top, and bottom and a front completely open or able to be closed with doors.

**mechanical system**  
Any of the systems that provide essential services to a building, as water supply, sewage disposal, electric power, heating, ventilation, air-conditioning, vertical transportation, or fire fighting.

**space heating**  
The heating of a limited area, as a room, esp. by means of a heat source located within the space.

**central heating**  
A mechanical system that supplies heat to an entire building from a single source through a network of ducts or pipes.

**vent**  
A pipe by which products of combustion are carried from a furnace or other appliance to the outside.

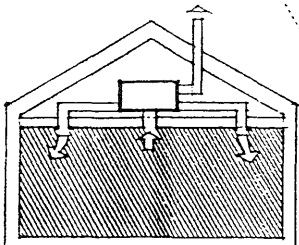
**heating medium**  
A fluid substance, as warm air, hot water, or steam, capable of conveying heat from a source to the space being heated.

**thermostat**  
A device that automatically responds to changes in temperature and activates switches controlling such equipment as furnaces, refrigerators, and air conditioners.

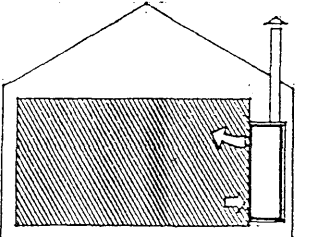
**thermocouple**  
A device for measuring temperature in which a pair of dissimilar metals, as copper and iron, are joined so that a potential difference generated between the points of contact is a measure of the temperature difference between the points.

**bimetallic element**  
A material made by bonding two metallic strips having different coefficients of expansion, used in temperature-indicating and temperature-controlling devices.

**combustion air**  
The air required for combustion of fuel in a furnace.



**horizontal furnace**  
A furnace designed for installation in a low attic or crawlspace.



**wall furnace**  
A furnace recessed in or mounted on a wall and supplying heated air directly to a space without the use of ducts.

**furnace**  
An apparatus in which heat is produced, as for heating a house or producing steam.

**electric furnace**  
A furnace in which the heat required is produced through electricity.

**gas furnace**  
A furnace using gas as a fuel.

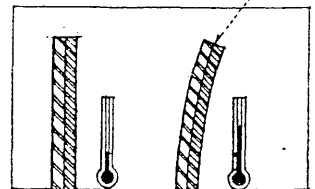
**oil burner**  
A furnace or boiler that burns fuel oil.

**conversion burner**  
A burner designed for installation in a furnace that originally used another fuel.

**heating load**  
The hourly rate of net heat loss in an enclosed space, expressed in Btu per hour and used as the basis for selecting a heating unit or system.

**heating degree day**  
A degree-day below the standard temperature of 65°F (19°C), used in estimating fuel or power consumption by a heating system.

**degree day**  
A unit that represents one degree of departure in the mean daily outdoor temperature from a given standard temperature.



# HEAT

## forced warm-air heating

A system for heating a building by means of air heated in a furnace and distributed by a fan through ductwork to registers or diffusers.

## extended plenum system

A perimeter heating system in which a main duct conveys warm air to a number of branch ducts, each serving a single floor register.

## bonnet

A chamber at the top of a hot-air furnace from which the leaders emerge. Also called plenum.

## leader

A duct for conveying warm air from a furnace to a stack or branch duct. Also called main, trunk.

## manifold

A pipe or duct fitting having several outlets for making multiple connections.

## gathering

A tapered section of a duct or flue forming a transition between two sections, one of which has a greater area than the other.

## boot

A duct fitting forming a transition between two sections which vary in cross-sectional shape.

## duct

A pipe or conduit of sheet metal or fiberglass for conducting heated or conditioned air. Also called air duct.

## ductwork

A system of ducts, connectors, and dampers for conveying air in a heating, ventilating, or air-conditioning system. Also called ducting.

## stack

A vertical duct for conveying warm air from a leader to a register on an upper floor.

## chase

A continuous space or recess built into a wall or through a floor for pipes or ducts.

## grille

A grating or perforated screen for covering, concealing, or protecting a wall, floor, or ceiling opening.

## register

A device for controlling the flow of warm or conditioned air from an outlet, composed of a grill with a number of parallel blades that may be adjusted so as to overlap and close the opening.

## flexible duct

A pliable, airtight fitting installed between two ducts, or between a fan and a duct, to prevent the transmission of noise and vibrations along the ductwork.

## duct liner

A fiberglass blanket for lining the inside of a duct to reduce noise and serve as thermal insulation.

## perimeter heating

A heating system that distributes warm air to registers placed in or near the floor along exterior walls.

## perimeter loop system

A perimeter heating system in which a loop of ductwork, usually embedded in a concrete ground slab, distributes warm air to each floor register.

## perimeter radial system

A perimeter heating system in which a leader from a centrally located furnace carries warm air directly to each floor register.

## throw

The distance a projected airstream travels from an outlet to a point where its velocity is reduced to a specified value.

## terminal velocity

The average velocity of a projected airstream at the end of the throw.

## drop

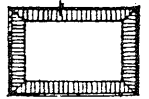
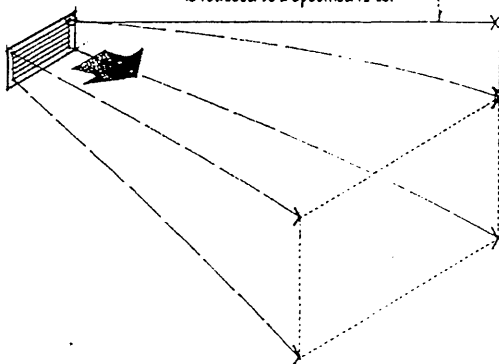
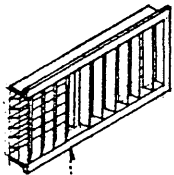
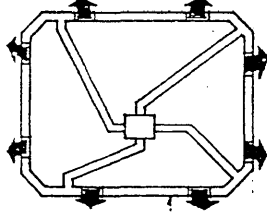
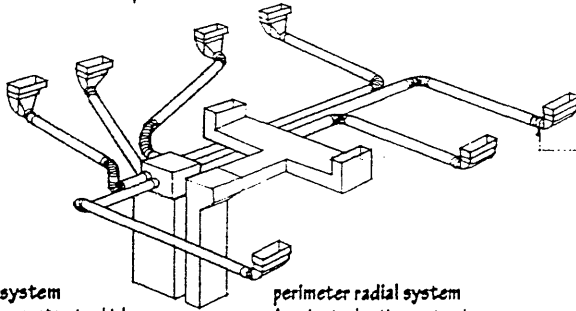
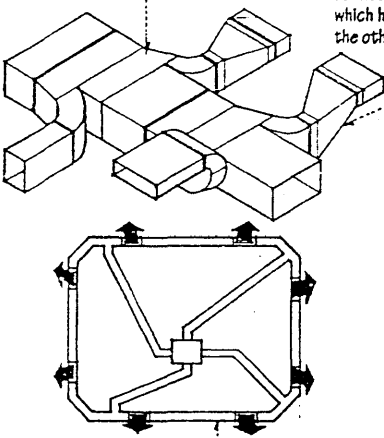
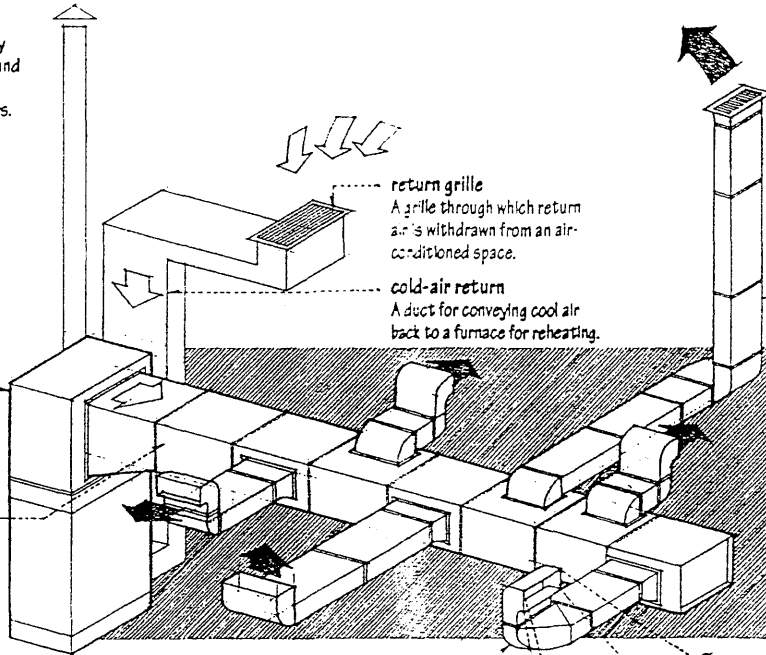
The vertical distance a horizontally projected airstream falls from the elevation of its outlet, measured at the end of the throw.

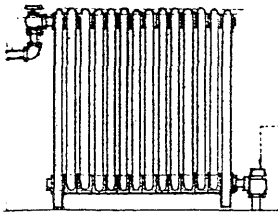
## spread

The extent to which a projected airstream diffuses at the end of the throw.

## diffuser

A device having slats at different angles for deflecting warm or conditioned air from an outlet in various directions.



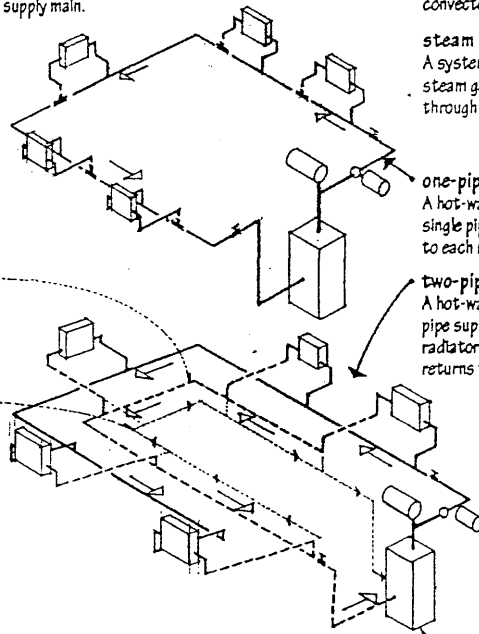


**radiator**  
A heating device consisting of a series or coil of pipes through which hot water or steam passes.

**bucket trap**  
A valve for eliminating air and condensed moisture from a radiator without allowing steam to escape. Also called **steam trap**.

**bleeder**  
A valve for draining a pipe, radiator, or tank. Also called **bleeder valve**.

**venturi tee**  
A special fitting used in a one-pipe system to induce the flow of water from a return branch into the supply main.

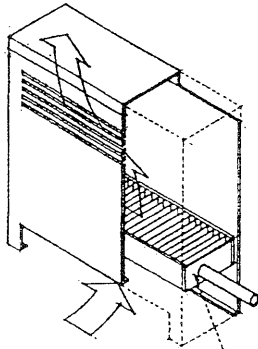


**hot-water heating**  
A system for heating a building by means of water heated in a boiler and circulated by a pump through pipes to radiators or convectors. Also called **hydronic heating**.

**steam heating**  
A system for heating a building by means of steam generated in a boiler and circulated through pipes to radiators.

**one-pipe system**  
A hot-water heating system in which a single pipe supplies hot water from a boiler to each radiator or convector in sequence.

**two-pipe system**  
A hot-water heating system in which one pipe supplies hot water from a boiler to the radiators or convectors and a second pipe returns the water to the boiler.

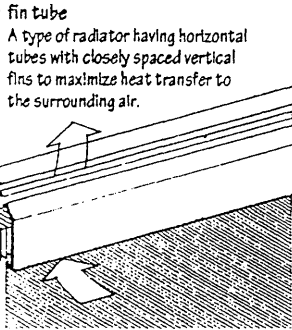


**convector**  
A heating unit in which air heated by contact with a radiator or fin tube circulates by convection.

**reverse return**  
A two-pipe hot-water system in which the lengths of the supply and return pipes for each radiator or convector are nearly equal.

**direct return**  
A two-pipe hot-water system in which the return pipe from each radiator or convector takes the shortest route back to the boiler.

**dry return**  
A return pipe in a steam-heating system that carries both air and water of condensation.



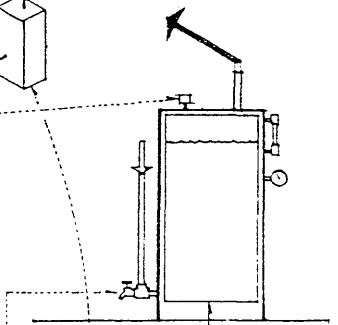
**fin tube**  
A type of radiator having horizontal tubes with closely spaced vertical fins to maximize heat transfer to the surrounding air.

**baseboard heater**  
A long, narrow hydronic or electric convector designed for installation along the base of a wall.

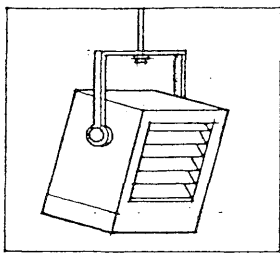
**safety valve**  
A relief valve that opens when actuated by a gas or vapor pressure above a predetermined level, allowing the gas or vapor to escape until its pressure is reduced to a safe or acceptable level.

**relief valve**  
A valve that opens when actuated by static pressure above a predetermined level in order to reduce the pressure to it.

**petcock**  
A small faucet or valve for draining or releasing compression in pipes, radiators, and boilers.



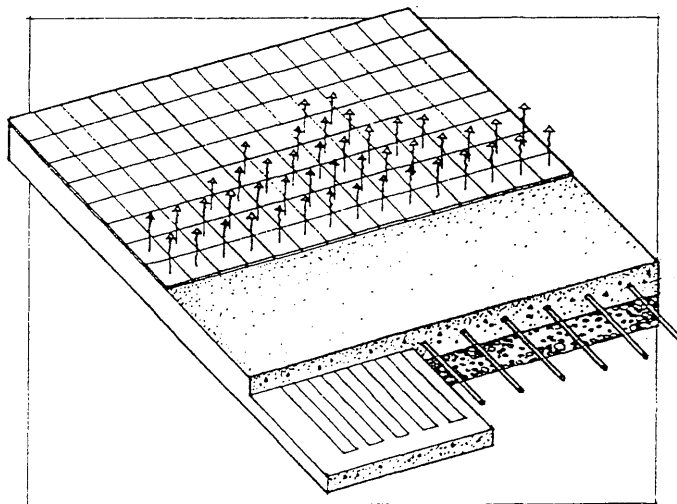
**boiler**  
A closed vessel or arrangement of vessels and tubes in which water is heated or steam is generated to supply heat or power.



**unit heater**  
A self-contained electric or gas-fired space heater, consisting of a heating element, fan, and a directional outlet.

**space heater**  
A device for heating the space in which it is located, esp. a unit that has no external heating ducts or connection to a chimney.

**quartz heater**  
An electric space heater having heating elements sealed in quartz-glass tubes that produce infrared radiation in front of a reflective backing.



**electric heat**  
Heat generated by the resistance of a conductor to the flow of electric current.

**panel heating**  
The radiant heating of a room or building by means of wall, floor, baseboard, or ceiling panels containing electrical conductors, hot-water pipes, or hot-air ducts.

**radiant heating**  
A system for heating by radiation from a surface, esp. one that is heated by means of electric resistance or hot water.

# HEAT

## air conditioning

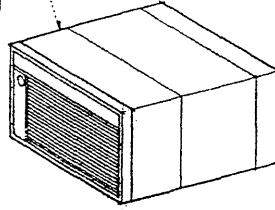
A system or process for simultaneously controlling the temperature, humidity, purity, distribution, and motion of the air in an interior space, esp. one capable of cooling.

## air conditioner

Any device or apparatus for controlling, esp. lowering, the temperature and humidity of a space.

## packaged air conditioner

A factory-assembled air conditioner having a fan, filters, compressor, condenser, and evaporator coils for cooling. For heating, the unit may operate as a heat pump or contain auxiliary heating elements.



## load

The demand placed on a heating, ventilating, or air-conditioning system in order to maintain the desired conditions of thermal comfort in a building.

## cooling load

The hourly rate of heat gain in an enclosed space, expressed in Btu per hour and used as the basis for selecting an air-conditioning unit or system.

## cooling degree-day

A degree-day above the standard temperature of 75°F (24°C), used in estimating energy requirements for air-conditioning and refrigeration.

## cooling medium

A fluid substance, as chilled water or cool air, for removing heat, as from the interior spaces of a building.

## ton of refrigeration

The cooling effect obtained when 1 ton of ice at 32°F (0°C) melts to water at the same temperature in 24 hours, equivalent to 12,000 Btu/hr. (3.5 kW).

## energy efficiency rating

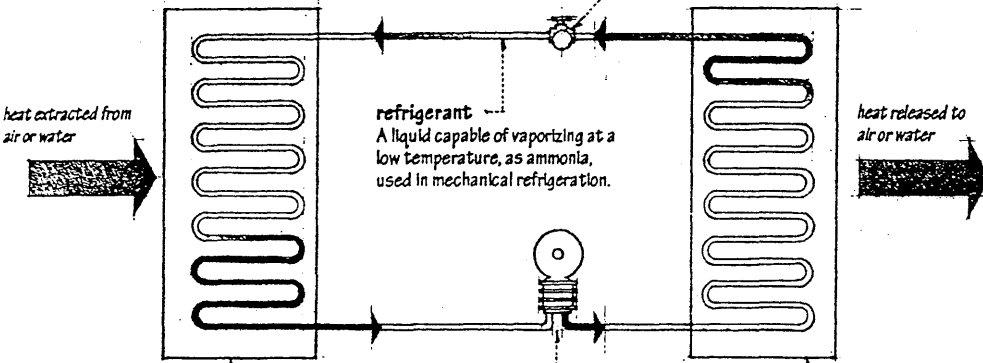
An index of the efficiency of a refrigerating unit, expressing the Btu removed per watt of electrical energy input.

## compressive refrigeration

A refrigeration process in which cooling is effected by the vaporization and expansion of a liquid refrigerant.

## expansion valve

A valve that reduces the pressure and evaporation temperature of a refrigerant as it flows to the evaporator.



**refrigerant**  
A liquid capable of vaporizing at a low temperature, as ammonia, used in mechanical refrigeration.

**evaporator**  
The component of a refrigeration system in which the refrigerant absorbs heat from a cooling medium and changes from a liquid to a gas.

**compressor**  
A pump or other machine for reducing the volume and increasing the pressure of a gas.

**condenser**  
A device for reducing a vapor or gas to liquid or solid form.

## coolant

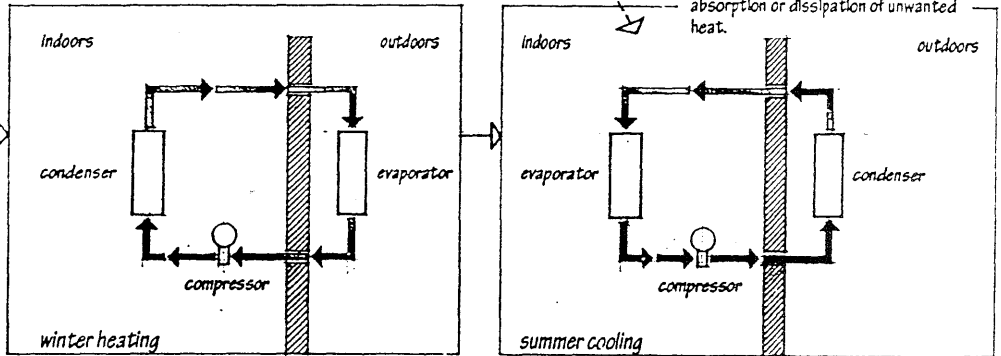
A fluid agent for reducing the temperature of a system below a specified value by conducting away the heat produced in the operation of the system.

## heat sink

A medium or environment for the absorption or dissipation of unwanted heat.

## heat pump

A device that uses a compressible refrigerant to transfer heat from one reservoir to another, with the process being reversible so that it can be used for both heating and cooling a building.



## absorption refrigeration

A refrigeration process that uses a generator and an absorber instead of a compressor to transfer heat.

## evaporator

heat extracted by means of a heat exchanger to produce chilled water for cooling

## heat exchanger

A device for transferring the heat of a fluid flowing on one side of a barrier to a fluid flowing on the other.

waste heat extracted from steam as it condenses before returning to evaporator

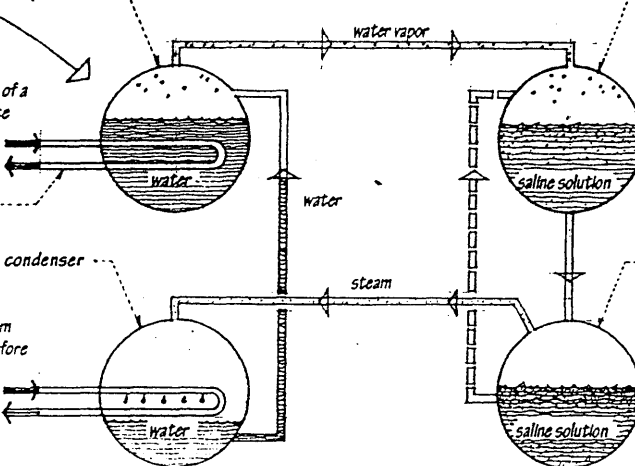
## condenser

## absorber

The component of an absorption-refrigeration system that uses a saline solution to draw water vapor from the evaporator, cooling the remaining water in the process.

## generator

The component of an absorption-refrigeration system that uses a heat source to remove excess water vapor from a saline solution.

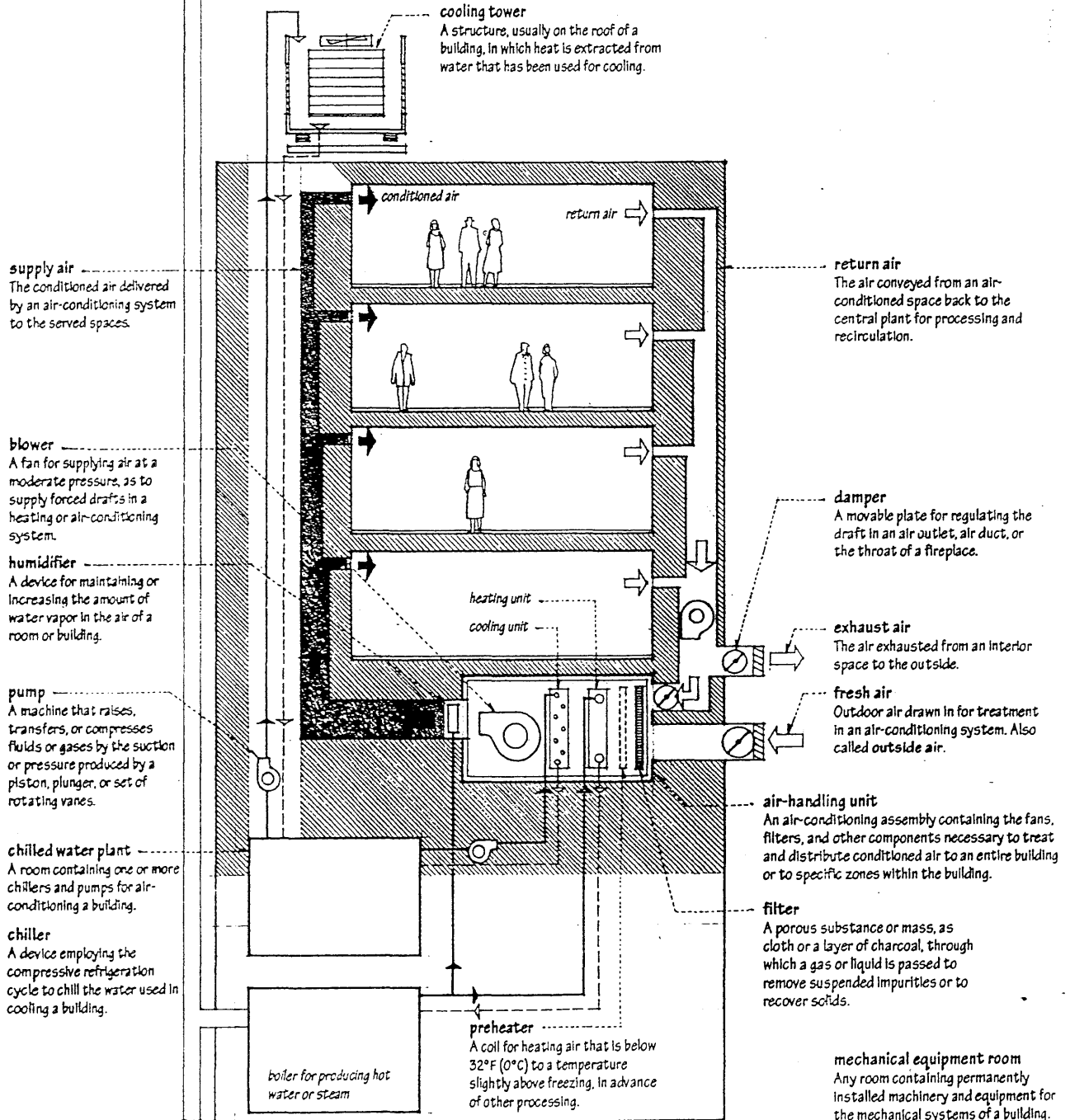


**central air conditioning**

An air-conditioning system that treats air at a central location and distributes the conditioned air to an entire building by means of fans and ductwork.

**HYAC**

Abbreviation for heating, ventilating, and air conditioning.



# HEAT

## all-water system

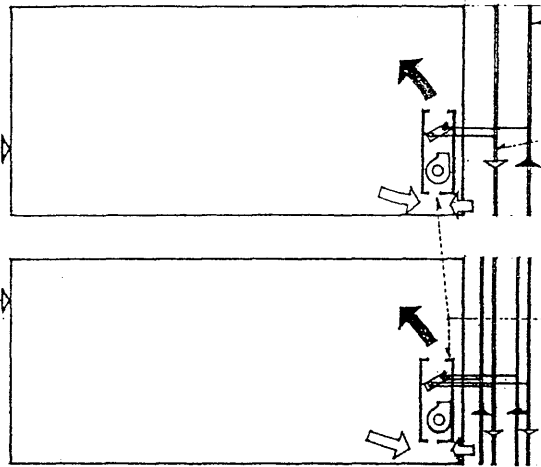
An air-conditioning system in which either hot or chilled water is piped to fan-coil units in the served spaces, where air is circulated locally.

### two-pipe system

An all-water system in which one pipe supplies the hot or chilled water to fan-coil units, and the other pipe returns it to the boiler or chilled water plant.

### four-pipe system

An all-water system in which separate hot-water and chilled-water piping circuits provide for simultaneous heating and cooling as needed in various zones of a building.



### supply pipe

A pipe for conveying hot or chilled water from the boiler or chilled-water plant to a fan-coil unit.

### return pipe

A pipe for conveying water from a fan-coil unit to the boiler or chilled-water plant.

### terminal unit

Any of various devices for delivering a heating or cooling medium to a space.

### fan-coil unit

A terminal unit containing an air filter, heating or cooling coils, and a centrifugal fan for drawing in a mixture of room air and outside air.

### coil

A connected series of pipes or tubing in rows or layers, often having fins attached to dissipate heat.

## all-air system

An air-conditioning system in which central fans distribute conditioned air to the served spaces by means of ductwork.

### single-duct system

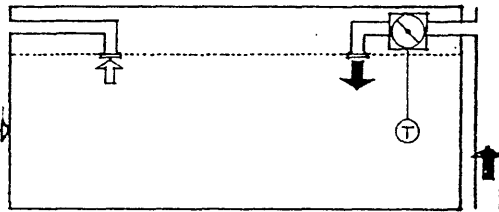
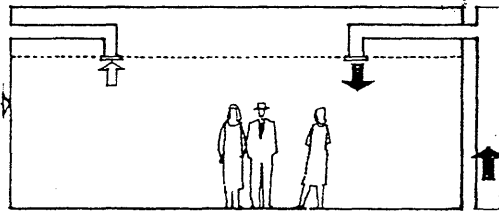
An all-air system in which a single duct conveys conditioned air to the served spaces.

### constant-air-volume system

An all-air system in which a master thermostat automatically regulates the quantity of conditioned air supplied to each zone.

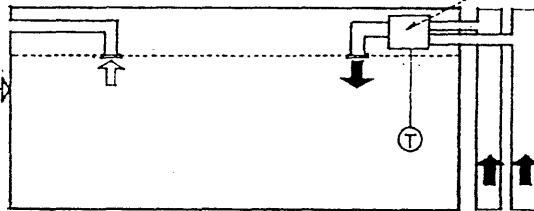
### variable-air-volume system

An all-air system in which a thermostatically controlled variable-volume box regulates the quantity of conditioned air supplied to each zone.



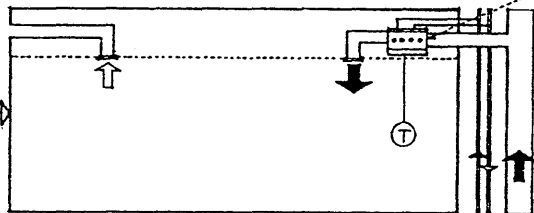
### dual-duct system

An all-air system in which separate cold-air and warm-air supply ducts meet at a mixing box where the air is blended before distribution to each zone.



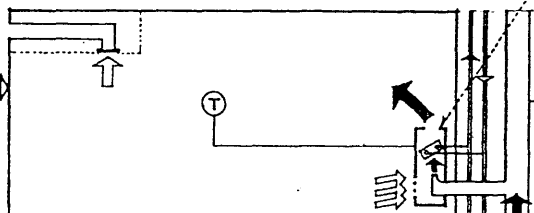
### terminal reheat system

An all-air system in which a reheat coil regulates the temperature of the air being furnished to each individually controlled zone.



## air-water system

An air-conditioning system in which high-velocity ducts supply conditioned air from a central plant to each zone where it mixes with room air and is further heated or cooled in an induction or fan-coil unit.



### multizone system

A central air-handling unit capable of serving up to eight zones simultaneously.

### zone

A space or group of spaces in a building whose temperature and air quality is regulated by a single control.

### mixing box

A chamber for proportioning and blending cold and warm air under thermostatic control to reach the desired temperature.

### reheat coil

An electric or hot-water coil for raising the temperature of the air in the supply duct of an air-conditioning system.

### induction unit

A terminal unit in which primary air draws in room air through a filter and the mixture passes over coils that are either heated or chilled by secondary water from a boiler or chilled water plant.

### high-velocity duct

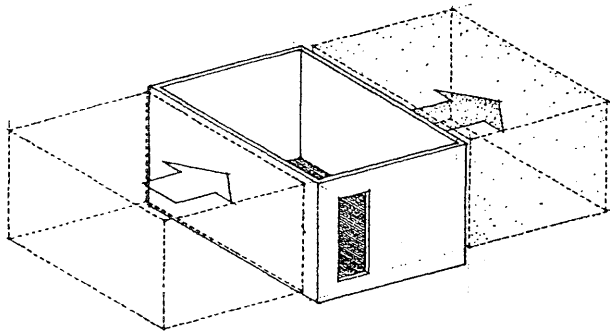
A small duct capable of conveying primary air at a velocity of 2,400 ft. (730 m) per minute or higher.

### primary air

The conditioned air supplied at a high pressure and high velocity by a central air handling unit.

**vent**

An opening, as in a wall, serving as an outlet for air, smoke, fumes, or the like.



**air change**

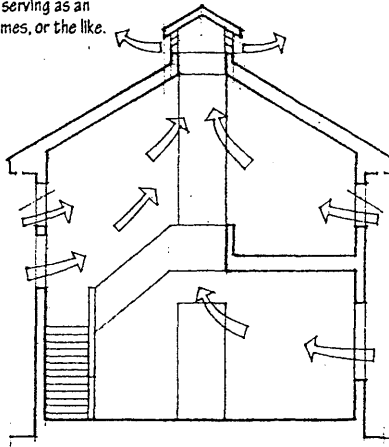
The replacement of the volume of air contained within a room with an equivalent volume of fresh air within a given period of time. The term **air changes-per-hour** is often used to specify ventilation standards.

**ventilate**

To provide a room with fresh air to replace air that has been used or contaminated.

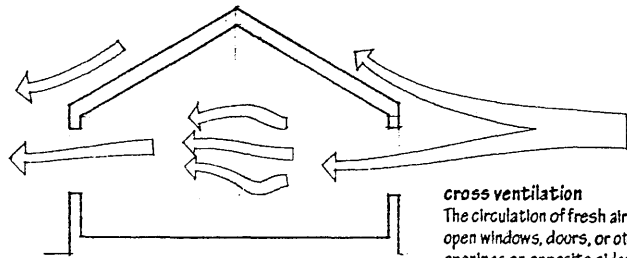
**natural ventilation**

The process of ventilating a space by the natural movement of air rather than by mechanical means.



**chimney effect**

The tendency of air or gas in a shaft or other vertical space to rise when heated, creating a draft that draws in cooler air or gas from below.



**cross ventilation**

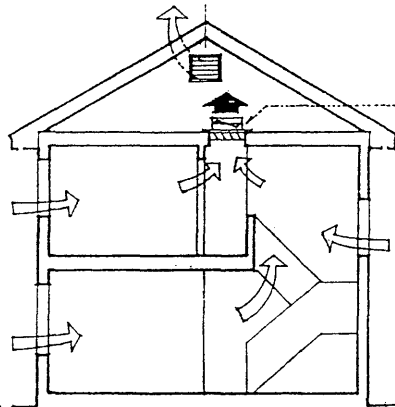
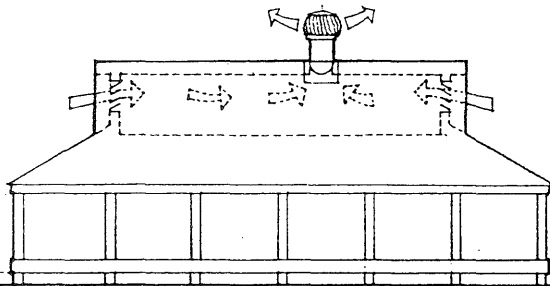
The circulation of fresh air through open windows, doors, or other openings on opposite sides of a room.

**ventilator**

A louvered opening or motor-driven fan for replacing stagnant air with fresh air.

**attic ventilator**

A wind- or motor-driven fan for assisting the natural air flow through an attic space.

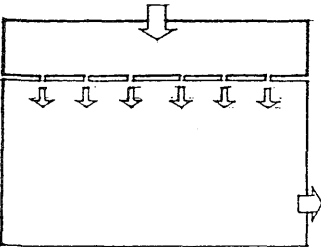


**whole-house ventilator**

A motor-driven fan for pulling stale air from the living areas of a house and exhausting it through attic vents.

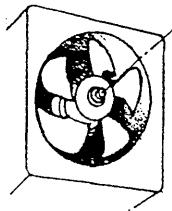
**mechanical ventilation**

The process of supplying fresh air to a building or removing stale air from it by mechanical means, as with fans.



**plenum ventilation**

A system of mechanical ventilation in which fresh air is forced into the space to be ventilated from a chamber (plenum chamber) at a pressure slightly higher than atmospheric pressure, so as to expel stale air.



**fan**

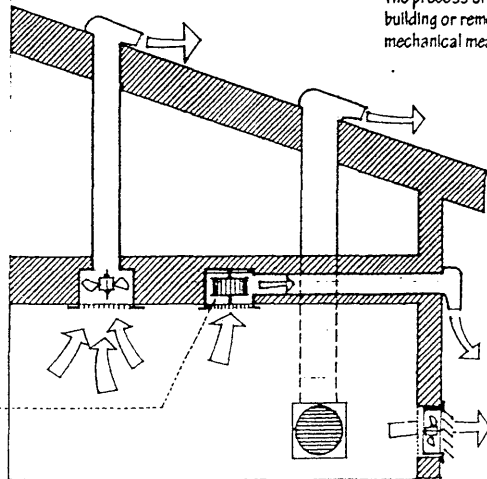
A device that rotates an array of blades or vanes about an axis in order to produce a current of air.

**exhaust fan**

A fan for ventilating an interior space by drawing air from the interior and expelling it outside.

**centrifugal fan**

A fan that receives air along its axis and discharges it radially.



# HISTORY

**A systematic, often chronological narrative of significant events as relating to a particular people, country, or period, often including an explanation of their causes.**

## civilization

An advanced state of human society marked by a relatively high level of cultural, technical, and political development.

## society

An enduring and cooperating large-scale community of people having common traditions, institutions, and identity, whose members have developed collective interests and beliefs through interaction with one another.

## culture

The integrated pattern of human knowledge, beliefs, and behaviors built up by a group of human beings and transmitted from one generation to the next.

## style

A particular or distinctive form of artistic expression characteristic of a person, people, or period.

## expression

The manner in which meaning, spirit, or character is symbolized or communicated in the execution of an artistic work.

## prehistoric

Of, pertaining to, or existing in the time prior to the recording of human events, knowledge of which is gained mainly through archaeological discoveries, study, and research.

## Stone Age

The earliest known period of human culture, preceding the Bronze Age and the Iron Age and characterized by the use of stone implements and weapons.

## Neolithic

Of or relating to the last phase of the Stone Age, characterized by the cultivation of grain crops, domestication of animals, settlement of villages, manufacture of pottery and textiles, and use of polished stone implements: thought to have begun c3000–8000 B.C.



## Lascaux Cave

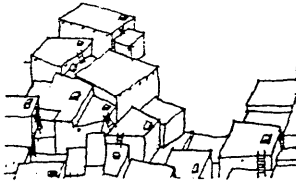
A cave in Lascaux, France, containing wall paintings and engravings thought to date from c13,000–8500 B.C.

## Mesopotamia

An ancient region in western Asia between the Tigris and Euphrates rivers, comprising the lands of Sumer and Akkad and occupied successively by the Sumerians, Babylonians, Assyrians, and Persians: now part of Iraq.

## Fertile Crescent

An agricultural region arching from the eastern shores of the Mediterranean Sea in the west to Iraq in the east: the location of humankind's earliest cultures.



## Catal Hüyük

A Neolithic settlement in Anatolia, dated 6500–5000 B.C. One of the world's earliest cities, it had mud-brick fortifications and houses, frescoed shrines, a fully developed agriculture, and extensive trading in obsidian, the chief material for tool-making.

## Anatolia

A vast plateau between the Black, Mediterranean, and Aegean Seas, synonymous with the peninsula of Asia Minor: today comprises most of Turkey.

## Bronze Age

A period of human history that began c4000–3000 B.C., following the Stone Age and preceding the Iron Age, characterized by the use of bronze implements.



## Yang-shao

A Neolithic culture in China centered around the fertile plains of the Yellow River, characterized by pit dwellings and fine pottery painted in geometric designs.

## Sumerian architecture

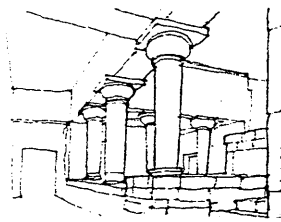
The architecture developed by the Sumerians who dominated southern Mesopotamia from the 4th to the end of the 3rd millennium B.C., characterized by monumental temples of sun-dried brick faced with burnt or glazed brick, often built upon the ruins of their predecessors.

## Sumer

An ancient region in southern Mesopotamia, where a number of independent cities and city-states were established as early as 5000 B.C. A number of its cities, as Eridu, Uruk, and Ur, are major archeological sites.

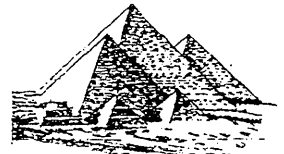
## tell

An artificial mound accumulated from the remains of one or more ancient settlements: often used in the Middle East as part of a place name.



## Egyptian Architecture

The architecture of the ancient civilization that flourished along the Nile River in northwest Africa from before 3000 B.C. to its annexation by Rome in 30 B.C., characterized esp. by the axial planning of massive masonry tombs and temples, the use of trabeated construction with precise stonework, and the decoration of battered walls with pictographic carvings in relief. A preoccupation with eternity and the afterlife dominated the building of these funerary monuments and temples, which reproduced the features of domestic architecture but on a massive scale using stone for permanence.



## Minoan architecture

The architecture of the Bronze Age civilization that flourished on Crete from about 3000 to 1100 B.C., named after the legendary King Minos of Knossos and characterized by the elaborate palaces at Knossos and Phaistos.

## 3000 BC

## Harappa

A Bronze Age culture that flourished in the Indus valley c2300–1500 B.C.



## Chinese architecture

The indigenous architecture of a vast country in eastern Asia whose civilization has continually evolved and survived longer than any other nation in the world. Despite the marked diversity in the architecture of various regions caused by differences in geographic and climatic conditions, a unique system of wood frame construction gradually took shape over several millennia of innovation and synthesis and exerted a profound influence over the architecture of Korea, Japan, and Southeast Asia.

## Xia

A legendary dynasty in China, 2205–1766 B.C. Also, Hsia.

## Shang

A Chinese dynasty, c1600 B.C.–1030 B.C., marked by the introduction of writing, the development of an urban civilization, and a mastery of bronze casting. Also, Yin.

## Preclassic

Of or pertaining to Mesoamerican culture from 2200 B.C. to A.D. 100.

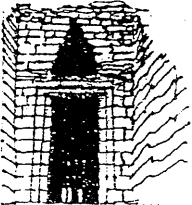


**Hittite architecture**

The architecture of the Hittite Empire which dominated Asia Minor and northern Syria from about 2000 to 1200 B.C., characterized by fortifications of cyclopean stone masonry and gateways with portal sculptures.

**Code of Hammurabi**

A Babylonian legal code instituted by Hammurabi in the mid-18th century B.C., based on principles absorbed from Sumerian culture.



**Mycenaean architecture**

The architecture of the Aegean civilization that spread its influence from Mycenae in southern Greece to many parts of the Mediterranean region from about 1600 to 1100 B.C., characterized by shaft graves, monumental beehive tombs, and palaces fortified with cyclopean walls.

**Assyrian architecture**

The Mesopotamian architecture developed under the Assyrian king-emperors of the 9th to 7th centuries B.C. Within city walls strengthened by towers with crenelated battlements, palaces took precedence over religious buildings. Vaulting played a greater role than in southern Mesopotamia and polychrome glazed brickwork showed the influence of Egyptian decoration.



**Greek architecture**

The architecture of the civilization that flourished on the Greek peninsula, in Asia Minor, on the north coast of Africa, and in the western Mediterranean until the establishment of Roman dominion in A.D. 146, characterized by a system of construction based on rules of form and proportion. Temples of post-and-lintel construction were continually refined in a quest for perfection and their design influenced a wide range of secular, civic buildings.

**Neo-Babylonian architecture**

The Mesopotamian architecture that developed after the decline of the Assyrian Empire, deriving much from Assyrian architecture and enhanced by figured designs of heraldic animals in glazed brickwork.

**Hanging Gardens of Babylon**

A series of irrigated ornamental gardens planted on the terraces of the Citadel, the palace complex in ancient Babylon; regarded as one of the Seven Wonders of the World.



**Persian architecture**

The architecture developed under the Achaemenid dynasty of kings who ruled ancient Persia from 550 B.C. until its conquest by Alexander the Great in 331 B.C., characterized by a synthesis of architectural elements of surrounding countries, as Assyria, Egypt, and Ionian Greece.

**Persian**

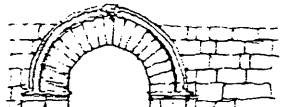
A telamon portrayed in Persian dress.

**Parthian architecture**

The architecture developed under Parthian rule in Iran and western Mesopotamia, from the 3rd century B.C. to the 3rd century A.D., combining classical with indigenous features.

**Etruscan architecture**

The architecture of the Etruscan people in west-central Italy from the 8th to 3rd centuries B.C., before the rise of Rome. Its construction methods, esp. that of the true stone arch, influenced later Roman architecture.



**Hellenic**

Of or pertaining to ancient Greek history, culture, and art, esp. before the time of Alexander the Great.

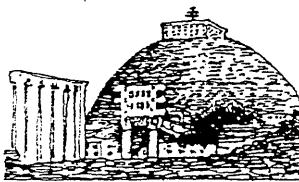
**Hellenistic**

Of or pertaining to Greek history, culture, and art from the time of Alexander the Great's death in 323 B.C. through the 1st century B.C., during which Greek dynasties were established in Egypt, Syria, and Persia, and Greek culture was modified by foreign elements.

4 BC

**Indian architecture**

The architecture of the Indian subcontinent, from the Indus valley culture of the Harappa to the Mauryan era, and later to periods of foreign domination and indigenous rule, characterized esp. by Hindu and Buddhist monuments, sometimes sharing the same site, and rhythmic, stratified multiplication of motifs and profuse carved ornamentation, often combining the religious and the sensuous.



**Maurya**

A member of an ancient Indian people who united northern India and established an empire c320 B.C.; architecture from this period shows the cultural influence of Achaemenid Persia and the first use of dressed stone.

**Zhou**

A Chinese dynasty, c1050 B.C.-256 B.C., marked by the division of China into separate feudal states and the emergence of Confucianism and Taoism, which gave thrust to all subsequent Chinese culture. Also, Chou.

**Confucianism**

A philosophy that dominated China until the early 20th century; an ethical system based on the teachings of the Chinese philosopher, Confucius, c551-478 B.C., emphasizing love for humanity, harmony in thought and conduct, devotion to family, and reverence for parents, including the spirits of one's ancestors.

**Taoism**

Chinese philosophy and religion considered next to Confucianism in importance. Based on the teachings of the Chinese philosopher, Lao-tzu, c604-531 B.C., it emphasizes a life of simplicity and noninterference with the course of natural events in order to attain a happy existence in harmony with the Tao. As a religion, it dates from A.D. 143, becoming popular during the decline of the Han dynasty and the introduction of Buddhism to China.

**Tao**

The Way; the creative principle that orders the universe.

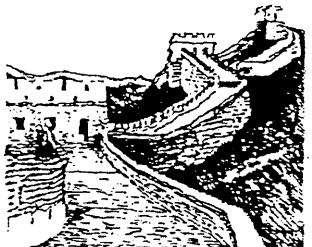


**Great Wall of China**

A fortified wall commenced under the Zhou dynasty to protect China against nomads from the north and serve as a means of communication. Various sections were built and connected until, during the Ming dynasty, 1368-1644, it extended for 1,500 miles (2,415 km), from southern Kansu province to the coast east of Peking. Rebuilt and refaced repeatedly, it is the only human-made construction visible from outer space.

**Qin**

A dynasty in China, 221-206 B.C., marked by the emergence of a centralized government and the construction of much of the Great Wall of China. Also, Ch'in.



**Olmec architecture**

The architecture of the Mesoamerican civilization which flourished c1200-500 B.C. In the tropical lowlands of the Mexican Gulf Coast, characterized by temple-pyramids and large ceremonial centers.



**Chavin**

A Peruvian culture lasting from c1000 B.C. to c200 B.C., based on the worship of the jaguar god and characterized by excellent stone sculpture, elaborate gold work, and remarkable ceramics; named after the town of that name in central Peru, where a complex of massive stone buildings with subterranean galleries surround formal courtyards.

**Mochica**

A pre-Incan culture that flourished on the northern coast of Peru from c200 B.C. to A.D. 700, noted for its fine pottery and the colossal Temple of the Sun, a terraced pyramid made entirely of adobe bricks. Also called Moche.

# HISTORY

## Classical architecture

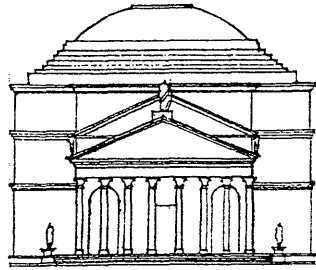
The architecture of ancient Greece and Rome, on which the Italian Renaissance and subsequent styles, as the Baroque and the Classic Revival, based their development.

## Roman architecture

The architecture of the ancient Roman people, characterized by massive brick and concrete construction employing such features as the semicircular arch, the barrel and groin vaults, and the dome, a simplicity and grandeur of massing often combined with elaborate detailing, the elaboration of the Greek orders as purely decorative motifs for the adornment of facades and interiors, and the use of marble linings, mosaics, and molded stucco in interiors.

## Rome

A city in the central part of Italy which, according to tradition, was founded by Romulus and Remus in 753 B.C.: ancient capital of the Roman Empire and site of Vatican City, the seat of authority of the Roman Catholic Church.



## Sassanian architecture

The architecture prevalent in Persia under the Sassanian dynasty that ruled A.D. 226–651, forming a link between the older Mesopotamian traditions and the Byzantine, and characterized by palaces with elliptical vaults and domes set on squinches and stuccoed masonry walls articulated by pilasters and cornices.

## Early Christian architecture

The final phase of Roman architecture, following the adoption of Christianity as the state religion by Constantine in A.D. 313 and lasting until the coronation of Charlemagne in A.D. 800 as emperor of the Holy Roman Empire, characterized by churches planned for congregational worship, esp. the basilica: coincident with and related to the rise of Byzantine architecture.

## Byzantine architecture

The architecture of the eastern sphere of the later Roman Empire, developing from late Roman and early Christian antecedents in the 5th century and influencing church building in Greece, Italy, and elsewhere for more than a thousand years: characterized by masonry construction, round arches, shallow domes carried on pendentives, and the extensive use of rich frescoes, colored glass mosaics, and marble revetments to cover whole interiors.

## Medieval architecture

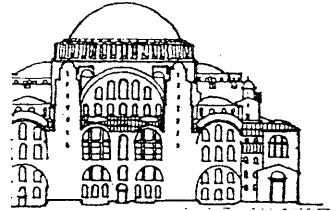
The architecture of the European Middle Ages, comprising the architecture of the Byzantine, pre-Romanesque, Romanesque, and Gothic periods.

## Middle Ages

The time in European history between classical antiquity and the Renaissance, often dated from A.D. 476 when Romulus Augustulus, the last Roman emperor of the Western Roman Empire, was deposed, to about 1500.

## Dark Ages

The early part of the Middle Ages, from about A.D. 476 to c.1100.



## AD 100

### Gupta

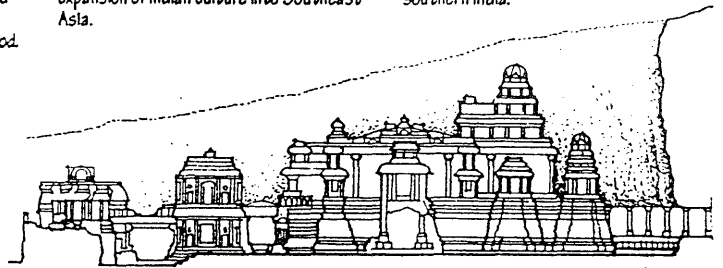
The dynasty of the Mauryan empire in northern India, A.D. 320–540, whose court was the center of classical Indian art and literature; the earliest substantial architectural remains are from this period.

### Pallava

A Hindu state established in southern India about A.D. 350; contributed to the expansion of Indian culture into Southeast Asia.

### Dravidian

A style of Indian architecture in the Pallava period, named after the language spoken in southern India.



## Pre-Columbian

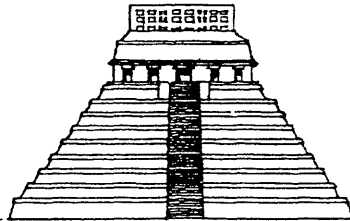
Of or pertaining to the Americas before the voyages of Columbus.

## Mesoamerica

The area extending from central Mexico and the Yucatán Peninsula to Honduras and Nicaragua in which pre-Columbian civilizations flourished. These cultures excelled in astronomy and the measurement of time, and shared temple-pyramids and a pantheon of deities including sun, wind, and rain gods.

## Classic

Of or pertaining to Mesoamerican culture from A.D. 100 to 900.



## Mayan architecture

The architecture of the Mesoamerican civilization of the Yucatán Peninsula, Guatemala, and part of Honduras, from the 1st century A.D. to its peak in the 9th century, characterized by magnificent ceremonial centers with temple-pyramids, ritual ball courts, spacious plazas, and palaces with sculptured facades.



## Zapotec architecture

The eclectic architecture of the Amerindian civilization which flourished c.500 B.C.–A.D. 1000 in the highland valley of Oaxaca in southern Mexico, assimilating influences from the Olmecs and from Teotihuacán during the Classic period.

## Tiahuanaco

A pre-Incan culture existing from about 300 B.C. to A.D. 900, chiefly in Peru and Bolivia, characterized by monolithic stone carving, polychrome pottery, and bronze artifacts.

**Romanesque architecture**

A style of architecture emerging in Italy and western Europe in the 9th century and lasting until the advent of Gothic architecture in the 12th century, comprising a variety of related regional styles and characterized by heavy, articulated masonry construction with narrow openings, the use of the round arch and barrel vault, the development of the vaulting rib and shaft, and the introduction of central and western towers for churches.

**Carolingian architecture**

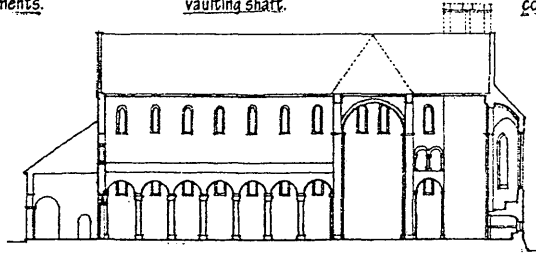
The early Romanesque architecture of the Frankish dynasty that reigned in France A.D. 751-987 and in Germany until A.D. 911, characterized by a revival of the forms of classical antiquity modified by ecclesiastical requirements.

**Lombard architecture**

The early Romanesque architecture of northern Italy during the 7th and 8th centuries, characterized by the use of Early Christian and Roman forms and the development of the ribbed vault and vaulting shaft.

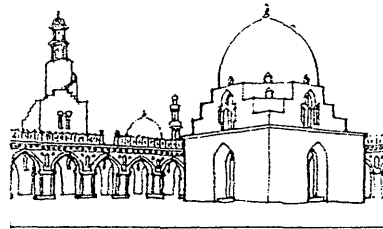
**Ottoman architecture**

The early Romanesque architecture of the German dynasty that ruled as emperors of the Holy Roman Empire from A.D. 962-1002, characterized by the development of forms derived from Carolingian and Byzantine concepts.



**Islamic architecture**

The architecture of the Muslim peoples from the 7th century on, developing in the wake of Muhammadan conquests of diverse territories from Spain in the west to India in the east and absorbing elements of art and architecture from each region: characterized by the development of the mosque as a distinct building type, masonry domes and tunnel vaults, round and horseshoe arches, and rich surface decorations incorporating calligraphy and floral motifs in a geometric framework because of the ban on human and animal representations. Also referred to as Muslim architecture.



**Anglo-Saxon architecture**

The early Romanesque architecture of England before the Norman Conquest in 1066, characterized by the translation of timber prototypes into stone.

**Norman architecture**

The Romanesque architecture introduced from Normandy into England before the Norman Conquest and flourishing until the rise of Gothic architecture c1200, characterized by the building of great Benedictine abbeys, the two-tower facade supplementing a central tower over the crossing, and the use of geometric ornamentation.

**Norman Conquest**

The conquest of England by the Normans under William the Conqueror, in 1066.



**Islam**

The religious faith of Muslims, based on the teachings of the prophet Muhammad, the central themes of which are belief in the one God, Allah, the existence of Paradise and Hell, and the universal Judgment Day to come. Also, the civilization built on Islamic faith. Also called Muhammadanism.

**Muhammad**

Arab prophet and founder of Islam, A.D. 570-632. Also, Mohammed.

**Moorish architecture**

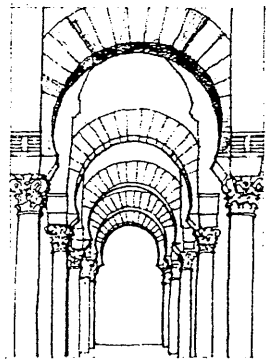
The Islamic architecture of North Africa and esp. of the regions of Spain under Moorish domination, characterized by the building of large mosques and elaborate fortress-palaces.

**Moor**

A member of the Muslim people of northwest Africa who invaded Spain in the 8th century and occupied it until 1492.

**Mozarabic style**

A style of Spanish architecture produced from the 9th to 15th centuries by Christians under Moorish influence, characterized by the horseshoe arch and other Moorish features.

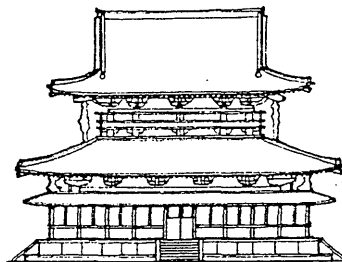


**Nara**

A period in Japanese history, A.D. 710-794, characterized by the adoption of Chinese culture and form of government: named after the first permanent capital and chief Buddhist center in ancient Japan.

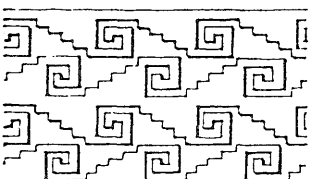
**Japanese architecture**

The architecture of the civilization that emerged on the Japanese archipelago off the east coast of Asia, characterized by a synthesis of seminal ideas from China and native conditions producing a distinctive style characterized by lightness, delicacy, and refinement.



**Heian**

Of or pertaining to the period in Japan, A.D. 785-1185, characterized by the modification and naturalization of ideas and institutions that were earlier introduced from China. During this time indigenous feudalism superseded Chinese-based social order and Japanese architecture developed in isolation from China.



**Mixtec architecture**

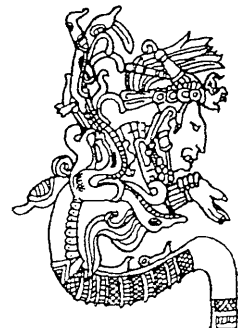
The architecture of the Amerindian culture centered in the Oaxaca Valley of Mexico from about A.D. 800 to the Spanish conquest, characterized by great stone masses, the use of interior stone columns, and the highly detailed fretwork of interior and exterior friezes.

**Toitec architecture**

The architecture of the Amerindian people who settled in central Mexico around A.D. 900 and who are traditionally credited with laying the foundation of Aztec culture: characterized by colossal basalt telemones of Toltec warriors, colonnades several ranks deep, and stone panels carved with human-headed jaguars and symbols of Quetzalcóatl, set in plain wall surfaces.

**Quetzalcóatl**

Priest-ruler of the Toltec people, who was deified as the feathered-serpent god called by that name.



**Gothic architecture**

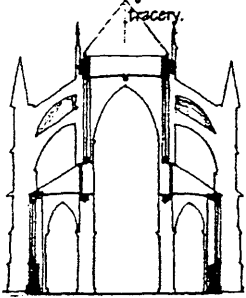
The style of architecture originating in France in the 12th century and existing in the western half of Europe through the middle of the 16th century, characterized by the building of great cathedrals, a progressive lightening and heightening of structure, and the use of the pointed arch, ribbed vault, and a system of richly decorated fenestration.

**Early French style**

The first of the three phases of French Gothic architecture, characterized by the pointed arch and geometric tracery.

**Early English style**

The first of the three phases of English Gothic architecture from the late 12th through the 13th centuries, characterized by the lancet window and plate tracery.



**Rayonnant style**

The middle phase of French Gothic architecture from the end of the 13th through the late 14th centuries, characterized by circular windows with radiating lines of tracery.

**Decorated style**

The second of the three phases of English Gothic architecture from the late 13th through the late 14th centuries, characterized by rich tracery, elaborate ornamental vaulting, and refinement of stonecutting techniques.

**Geometric style**

The early development of the Decorated style in the late 13th and early 14th centuries, characterized by the use of geometric tracery.

**Curvilinear style**

The later development of the Decorated style in the second half of the 14th century, characterized by use of curvilinear tracery.

**Flamboyant style**

The final phase of French Gothic architecture from the late 14th through the middle of the 16th centuries, characterized by flamelike tracery, intricacy of detailing, and frequent complication of interior space.

**Perpendicular style**

The final phase of English Gothic architecture prevailing from the late 14th through the early 16th centuries, characterized by perpendicular tracery, fine intricate stonework, and elaborate fan vaults. Also called Rectilinear style.

**1100**

**Mudéjar architecture**

A style of Spanish architecture produced from the 13th to 16th centuries by Mudéjars and Christians working within the Muslim tradition, characterized by a fusion of Romanesque and Gothic with Islamic elements.

**Mudéjar**

A Muslim permitted to remain in Spain after the Christian reconquest, esp. during the 8th to 13th centuries.

**Seljuk architecture**

The Islamic architecture of several Turkish dynasties that ruled over central and western Asia from the 11th to 13th centuries, much influenced by Persian architecture.

**Ottoman architecture**

The Islamic architecture of the Ottoman Empire from the 14th century on, much influenced by Byzantine architecture.

**minster**

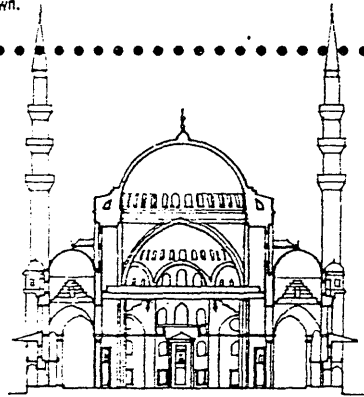
Originally, a monastery church; later, any large or important church, as a cathedral or the principal church of a town.



**duomo**  
Italian designation for a true cathedral.

**Quattrocento architecture**

The Italian Renaissance architecture of the 15th century.



**Chimu**

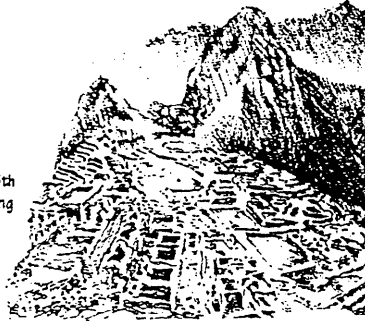
An Amerindian people inhabiting the northern coast of Peru and having a highly developed urban culture that lasted from about A.D.1000 to its destruction by the Incas c1470.

**Postclassic**

Of or pertaining to Mesoamerican culture from A.D. 900 to the Spanish conquest in 1519.

**Inca architecture**

The architecture of the Quechuan people who migrated into the Cuzco area about A.D. 1100 and ruled Peru until the Spanish conquest in the 16th century, characterized esp. by strong simple forms of smooth ashlar or polygonal masonry which was cut, finished, and fitted with great precision without the use of iron chisels.

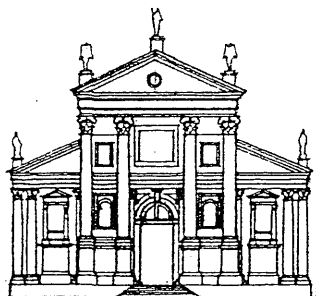


**Aztec architecture**

The architecture of the Amerindian people who settled near the shore of Lake Texcoco in central Mexico c1352 and who rose to dominance c1450; characterized chiefly by the pyramid supporting twin temples on a common platform, approached by parallel stairways. The destruction of Aztec architecture by the Spanish conquistadors have left few remains.

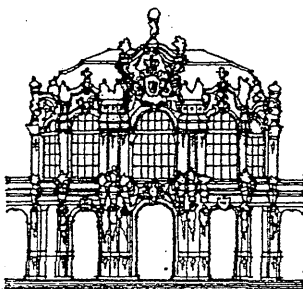
**Tudor architecture**

A transitional style of English architecture that developed during the reign of the royal house of Tudor in the second half of the 16th century, characterized by the Tudor arch and the application of Renaissance details to buildings otherwise late Perpendicular in style.



**High Renaissance**

A style of Italian Renaissance art and architecture developed in the late 15th and early 16th centuries, characterized by an emphasis on draftsmanship, the illusion of sculptural volume in painting, and in building, by the imitative use of whole orders and compositional arrangements in the classical style, with great attention to the formulation of compositional rules after the precepts of Vitruvius and the precedents of existing ruins.

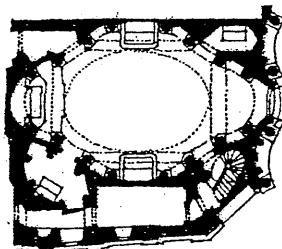


**zwinger**

A protective fortress in or adjoining a German city; by extension, a term for several German palaces or parts of palaces, as in Dresden.

**Baroque architecture**

A style of architecture originating in Italy in the early 17th century and variously prevalent in Europe and the New World for a century and a half, characterized by free and sculptural use of the classical orders and ornament, dynamic opposition and interpenetration of spaces, and the dramatic combined effects of architecture, sculpture, painting, and the decorative arts.



**Rococo**

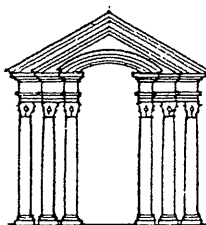
A style of decorative art that evolved from the Baroque, originating in France about 1720 and distinguished by fanciful, curved spatial forms and elaborate, profuse designs of shellwork and foliage intended for a delicate overall effect.

**Cinquecento architecture**

The Italian Renaissance architecture of the 16th century.

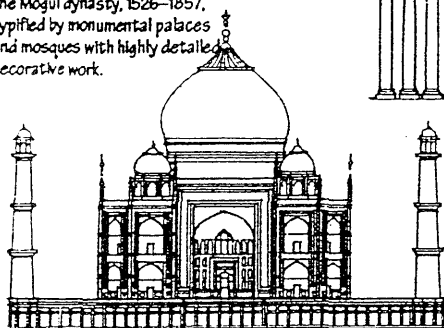
**Mannerism**

A transitional style in European architecture in the late 16th century, particularly in Italy, characterized by the unconventional use of classical elements. In the fine arts, Mannerism was chiefly characterized by a distortion of perspective, elongated forms, and intense, often strident color.



**Mogul architecture**

The Indo-Islamic architecture of the Mogul dynasty, 1526–1857, typified by monumental palaces and mosques with highly detailed decorative work.



1700

**chinoiserie**

A style of ornament prevalent chiefly in 18th-century Europe, characterized by intricate patterns and extensive use of motifs identified as Chinese.

**Georgian architecture**

The prevailing style of architecture, furniture, and crafts current in England and the North American colonies, esp. from 1714 to 1811, derived from classical, Renaissance, and Baroque forms; named after the four kings named George who reigned successively during this period.

**classicism**

The principles or styles characteristic of the culture, art, and literature of ancient Greece and Rome.

**Classic Revival**

Art and architecture in the style of the ancient Greeks and Romans, as that of the Italian Renaissance and the neoclassical movements in England and the United States in the late 18th and early 19th centuries. Also, Classical Revival.

**Neoclassicism**

The classicism prevailing in the architecture of Europe, America, and various European colonies during the late 18th and early 19th centuries, characterized by the introduction and widespread use of Greek and Roman orders and decorative motifs, the subordination of detail to simple, strongly geometric compositions, and the frequent shallowness of relief in ornamental treatment of facades.

**Colonial architecture**

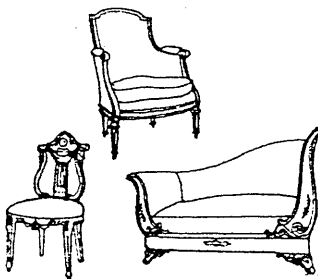
The style of architecture, decoration, and furnishings of the British colonies in America in the 17th and 18th centuries, mainly adapted to local materials and demands from prevailing English styles.

**Federal style**

The Classic Revival style of the decorative arts and architecture current in the U.S. from c1780 to c1830.

**Regency style**

The neoclassic style of architecture, furnishings, and decoration during the period in British history, 1811–20, during which George, Prince of Wales (later George IV) was regent; similar to the Directoire and Empire styles and characterized by close imitation of ancient Greek forms as well as by less frequent and looser adaptations of ancient Roman, Gothic, Chinese, and ancient Egyptian forms.



**Directoire style**

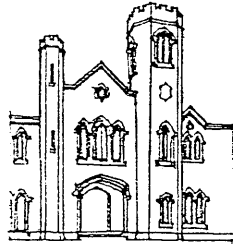
A style of French furnishings and decoration preceding the Empire style, characterized by an increasing use of Greco-Roman forms along with an introduction, toward the end, of Egyptian motifs; named after the Directory, the body of five directors forming the executive power of France from 1795–99.

**Empire style**

The neoclassic style of architecture, furnishings, and decoration prevailing in France and imitated in various other countries during the first French Empire, c1800–30, characterized by the use of delicate but elaborate ornamentation imitated from Greek and Roman examples and by the occasional use of military and Egyptian motifs.

**Gothic Revival**

A movement aimed at reviving the spirit and forms of Gothic architecture, originating in the late 18th century but flourishing mainly in the 19th century in France, Germany, England and to a lesser extent in the U.S. Gothic remained the accepted style for churches well into the 20th century.



**Victorian architecture**

The revival and eclectic architecture, decor, and furnishings popular in English-speaking countries during the reign of Queen Victoria of England, 1837-1901, characterized by rapid changes of style as a consequence of aesthetic controversy and technological innovations, by the frequent presence of ostentatious ornament, and by an overall trend from classicism at the start to romanticism and eclecticism at the middle of the period and thence to classicism again.

**Beaux-Arts architecture**

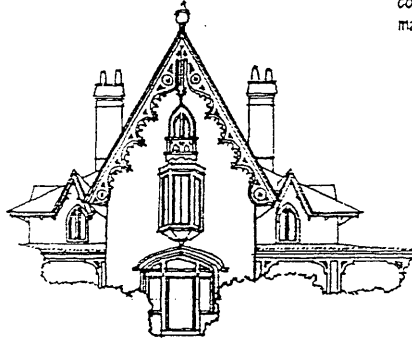
A style of architecture favored by the Ecole des Beaux-Arts in late 19th-century France and adopted in the U.S. and elsewhere c1900, characterized by symmetrical plans and the eclectic use of architectural features combined so as to give a massive, elaborate, and often ostentatious effect. The term is often used in a pejorative sense to designate excessive formalism disregarding considerations of structural truth, advanced aesthetic theory, rational planning, or economy.

**Steamboat Gothic**

A florid architectural style used for homes built in the middle of the 19th century in the Ohio and Mississippi river valleys, suggesting the gingerbread-decorated construction of riverboats of the Victorian period.

**collegiate Gothic**

A secular version of Gothic architecture, as in the older colleges of Cambridge and Oxford.



**Carpenter Gothic**

A style of Victorian Gothic architecture in the 19th century adapted by artisan-builders to the resources of contemporary woodworking tools and machinery.

**eclecticism**

A tendency in architecture and the decorative arts to freely mix various historical styles with the aim of combining the virtues of diverse sources, or of increasing allusive content, particularly during the second half of the 19th century in Europe and the U.S.

**gingerbread**

Heavily, gaudily, and superfluously ornamented, esp. in architecture.

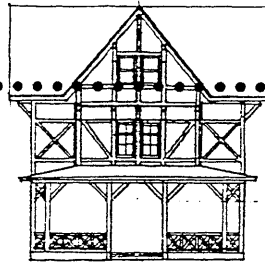
**eclectic**

Of or pertaining to works of architecture and the decorative arts that derive from a wide range of historic styles, the style in each instance being chosen for its deemed appropriateness to local tradition, geography, or culture.

**1800**

**Rationalism**

A design movement of the mid-19th century that emphasized the decorative use of materials and textures and the development of ornament as an integral part of a structure rather than as applied adornment.



**Stick style**

An eclectic style of American architecture in the second half of the 19th century, characterized esp. by the use of vertical board siding with battens or grids of boards over horizontal siding to express the frame construction beneath.

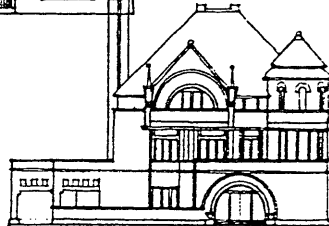
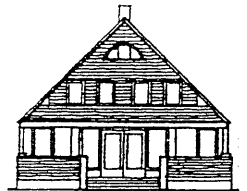


**Arts and Crafts Movement**

A movement that originated in England c1860 as a reaction against poor-quality mass-produced goods, conceiving of craft and decoration as a single entity in the handcrafting of both utilitarian and decorative objects.

**Shingle style**

An American style of domestic architecture during the second half of the 19th century, characterized by the extensive use of wood shingles as exterior cladding over a timber frame and frequently asymmetrical and fluid plan arrangements.

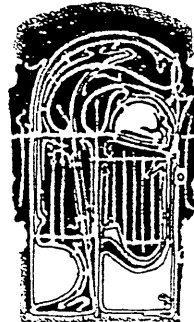


**Mission Style**

A style of architecture associated with that of early Spanish colonial missions in Mexico and the southwestern U.S., mainly in the 18th century.

**Richardsonian Romanesque**

The revival of the Romanesque style in the U.S. by Henry Hobson Richardson, 1838-86, and his followers, characterized by heavy arches, rusticated masonry walls, and dramatic asymmetrical effects.



**Art Nouveau**

A style of fine and applied art current in the late 19th and early 20th centuries, characterized by fluid, undulating motifs, often derived from natural forms.

**Stile Liberty**

The Italian version of Art Nouveau, named after the firm of Liberty and Co. in London.

**Sezession**

The Austrian version of Art Nouveau, so named because its adherents seceded from the official Academy of Art in Vienna.

**Modernismo**

The Spanish, particularly Catalan, version of Art Nouveau.

**Jugendstil**

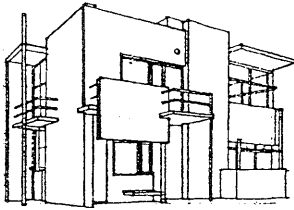
Art Nouveau as practiced in German-speaking countries: from the German term for youth style.

**Rundbogenstil**

A style of architecture in the mid-19th century, esp. in Germany, characterized by the use of the round-arch motif and combining in various degrees elements from the Early Christian, Byzantine, Romanesque, and Early Renaissance styles: from the German term for round-arched style.

**Bauhaus**

A school of design established in Weimar, Germany, in 1919 by Walter Gropius, moved to Dessau in 1926, and closed in 1933 as a result of Nazi hostility. The concepts and ideas developed at the Bauhaus were characterized chiefly by the synthesis of technology, craft, and design aesthetics, with an emphasis on functional design in architecture and the applied arts.

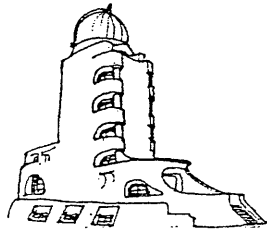


**de Stijl**

A school of art that was founded in the Netherlands in 1917, embracing painting, sculpture, architecture, furniture, and the decorative arts, marked esp. by the use of black and white with the primary colors, rectangular forms, and asymmetry. From "the style", the name of a magazine published by participants in the movement.

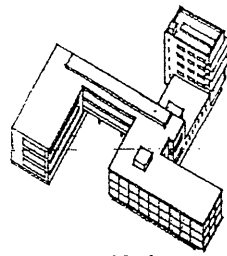
**cubism**

A style of painting and sculpture developed in the early 20th century, characterized by an emphasis on formal structure, the reduction of natural forms to their geometrical equivalents, and the organization of the planes of a represented object independently of representational requirements.



**abstract expressionism**

A movement in experimental, nonrepresentational painting originating in the U.S. in the 1940's, embracing many individual styles marked in common by freedom of technique, a preference for dramatically large canvases, and a desire to give spontaneous expression to the unconscious.

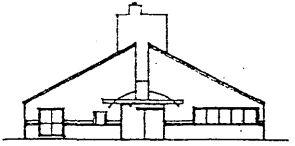


**International Style**

A functional architecture devoid of regional characteristics, developed in the 1920's and 1930's in Western Europe and the U.S. and applied throughout the world; characterized by simple geometric forms, large untextured, often white surfaces, large areas of glass, and general use of steel or reinforced concrete construction.

**brutalism**

A movement in architecture in the 1950's, emphasizing the aesthetic use of basic building processes, esp. of cast-in-place concrete, with no apparent concern for visual amenity.



**post-modernism**

A movement in architecture and the decorative arts that developed in the 1970's in reaction to the principles and practices of modernism, esp. the influence of the International Style, encouraging the use of elements from historical vernacular styles and often playful illusion, decoration, and complexity.

**decorated shed**

A design concept characterized by buildings of utilitarian design but having fronts intended to elevate their importance or to announce their functions.

**1900**

**Chicago School**

A group of U.S. architects active c1880-1910 and known for major innovations in high-rise construction and for the development of modern commercial building design.



**Organic architecture**

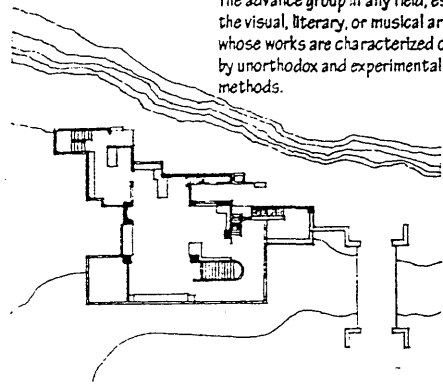
A philosophy of architectural design that emerged in the early 20th century, asserting that a building should have a structure and plan that fulfill its functional requirements, harmonize with its natural environment, and form an intellectually lucid, integrated whole. The shapes or forms in such a work are often of irregular contour and seem to resemble or suggest forms found in nature.

**Art Deco**

A style of decorative art developed originally in the 1920's with a revival in the 1960's, marked chiefly by geometric motifs, streamlined and curvilinear forms, sharply defined outlines, often bold colors, and the use of synthetic materials, as plastics; shortened from Exposition Internationale Des Arts Décoratifs et Industriels Modernes, an exposition of modern and decorative arts held in Paris, France, in 1925. Also called Style Moderne.

**avant-garde**

The advance group in any field, esp. in the visual, literary, or musical arts, whose works are characterized chiefly by unorthodox and experimental methods.

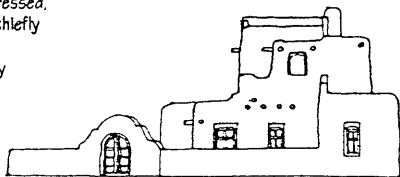


**Constructivism**

A movement which originated in Moscow after 1917, primarily in sculpture but with broad application to architecture. The expression of construction was to be the basis for all building design, with emphasis on functional machine parts.

**Functionalism**

A design movement that evolved from several previous movements in Europe in the early 20th century, advocating the design of buildings, furnishings, or the like as direct fulfillment of functional requirements, with the construction, materials, and purpose clearly expressed, and with aesthetic effect derived chiefly from proportions and finish to the exclusion or subordination of purely decorative effects.



**vernacular architecture**

A style of architecture exemplifying the commonest building techniques based on the forms and materials of a particular historical period, region, or group of people.

**high-tech**

A style of design incorporating industrial, commercial, and institutional fixtures, equipment, materials, or other elements having the utilitarian appearance characteristic of industrial design.

**deconstruction**

A philosophical and critical movement that started in the 1960's, esp. in the study of literature, questioning traditional assumptions about the ability of language to represent reality and emphasizing that a text has no stable reference because words essentially refer only to other words. A reader must therefore approach a text by eliminating any abstract reasoning or ethnocentric assumptions through an active role of defining meaning, sometimes by a reliance on etymology and new word construction.

# HOUSE

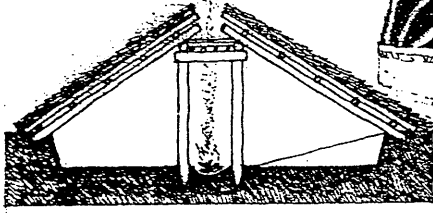
A building in which people live.

## shelter

Something beneath, behind, or within which a person is protected from storms or other adverse conditions.

## hut

A small, simple dwelling or shelter, esp. one made of natural materials.

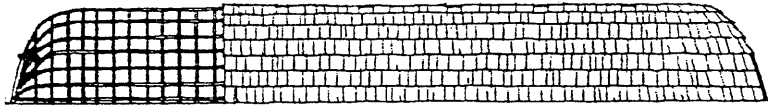


## pit dwelling

A primitive form of shelter consisting of a pit excavated in the earth and roofed over. Also called pit house.

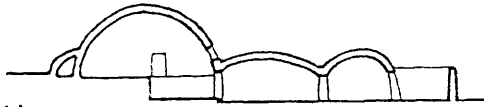
## lake dwelling

A dwelling, esp. of prehistoric times, built on piles or other supports over the water of a lake.



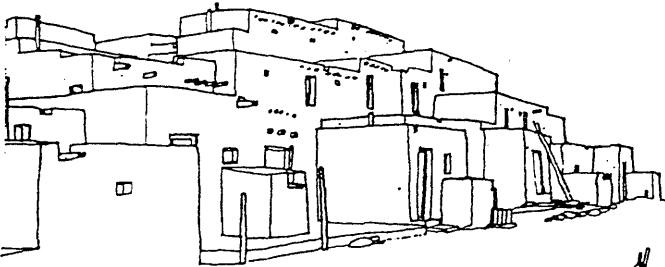
## longhouse

A communal dwelling characteristic of many early cultures, esp. that of the Iroquois and various other North American Indian peoples, consisting of a wooden, bark-covered framework often as much as 100 ft. (30.5 m) in length.



## igloo

An Eskimo house, usually built of blocks of hard snow or ice in the shape of a dome, or when permanent, of sod, wood, or stone. Also, iglu.

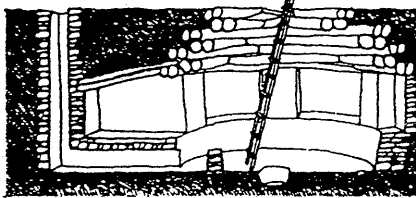


## pueblo

A communal dwelling and defensive structure of the Pueblo Indians of the southwestern U.S., built of adobe or stone, typically many-storied, and terraced, with entry through the flat roofs of the chambers by ladder. Pueblo structures were built on the desert floor, in valleys, or in the more easily defended cliff walls of mesas.

## mesa

A natural flat-topped elevation with one or more clifflike sides, common in arid and semiarid parts of the southwestern U.S. and Mexico.

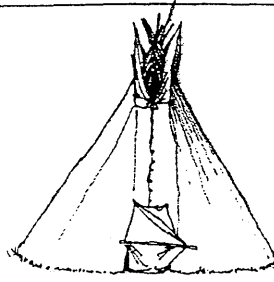
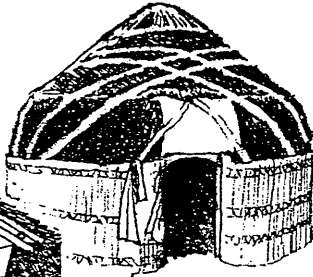


## kiva

A large underground or partly underground chamber in a Pueblo Indian village, used by the men for religious ceremonies or councils.

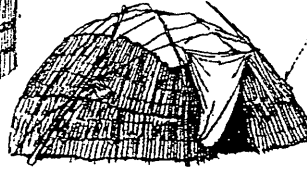
## yurt

A circular, tentlike dwelling of the Mongol nomads of central Asia, consisting of a cylindrical wall of poles in a lattice arrangement with a conical roof of poles, both covered by felt or animal skins.



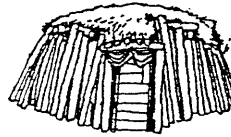
## teepee

A tent of the American Indians, made usually from animal skins laid on a conical frame of long poles and having an opening at the top for ventilation and a flap door. Also, teepee.



## wigwam

An American Indian dwelling, usually of round or oval shape, formed of poles overlaid with bark, rush mats, or animal skins.



## hogan

A Navaho Indian dwelling constructed usually of earth and logs and covered with mud and sod.

## sod house

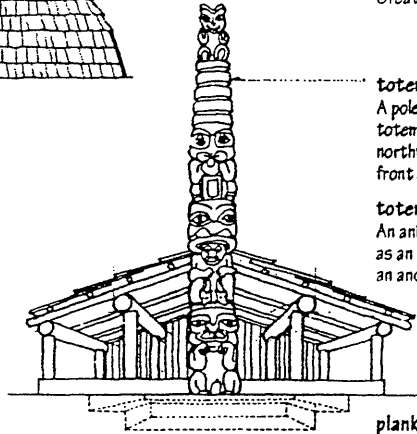
A house built of strips of sod, laid like brickwork, and used esp. by settlers on the Great Plains when timber was scarce.

## totem pole

A pole or post carved and painted with totemic figures, erected by Indians of the northwest coast of North America, esp. in front of their houses.

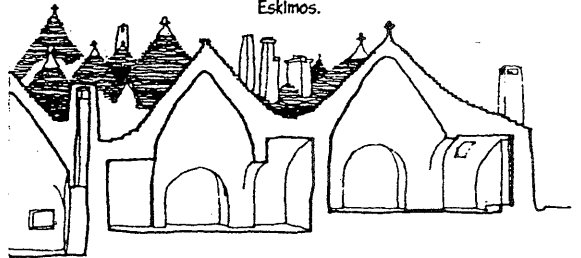
## totem

An animal, plant, or natural object serving as an emblem of a family or clan by virtue of an ancestral relationship.



## plank house

A large, usually rectangular house constructed of timber planks, built and used by Indians and, less frequently, by Eskimos.



## trullo

A circular stone shelter of the Apulia region of southern Italy, roofed with conical constructions of corbelled dry masonry, usually whitewashed and painted with figures or symbols. Many trulli are over 1,000 years old and still in use today, usually located among vineyards to serve as storage structures or as temporary living quarters during the harvest.



**compluvium**

A roof opening in an ancient Roman house, through which rainwater discharged into a cistern in the atrium beneath it.

**displuviate**

Having roofs sloping downward toward the compluvium.

**impluvium**

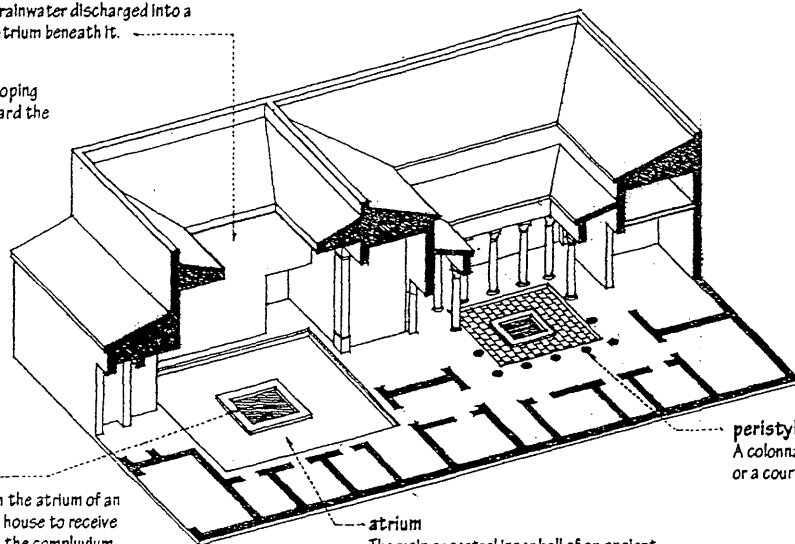
A cistern set in the atrium of an ancient Roman house to receive rainwater from the compluvium.

**atrium**

The main or central inner hall of an ancient Roman house, open to the sky at the center and usually having a pool for the collection of rainwater. Also called *cavaedium*.

**peristyle**

A colonnade surrounding a building or a courtyard.



**shoin**

An elevated bay or projected window with a raised sill serving as a desk for writing or reading, usually placed at a right angle to the tokonoma in the reception room of a shoin-zukuri style residence.

**kakemono**

A vertical hanging scroll containing either text or a painting, intended to be viewed on a wall and rolled when not in use.

**engawa**

An extension of the floor on one or more sides of a Japanese-style house, usually facing a garden and serving as a passageway or sitting space.

**tokonoma**

Picture recess: a shallow, slightly raised alcove for the display of a kakemono or flower arrangement. One side of the recess borders the outside wall of the room through which light enters, while the interior side adjoins the tana. As the spiritual center of a traditional Japanese house, the tokonoma is located in its most formal room.

**tokobashira**

A post marking the front of the partition between the tokonoma and the tana, sometimes of exquisite wood of particular grain and shape.

**shoin-zukuri**

A ceremonial style of Japanese residential architecture in the Kamakura period, deriving its name from the characteristic shoin or study-bay and marked by a hierarchical arrangement of public and private rooms.

**zashiki**

Reception room: the main room in a traditional Japanese house, used for receiving and entertaining guests. Its importance is evident in the presence of a tokonoma, tana, and shoin.

**tana**

In Japanese residential architecture, a recess with built-in shelving, usually adjoining a tokonoma.

**shoji**

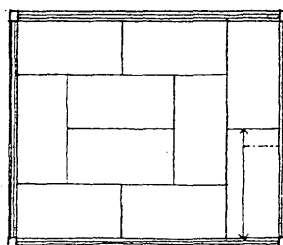
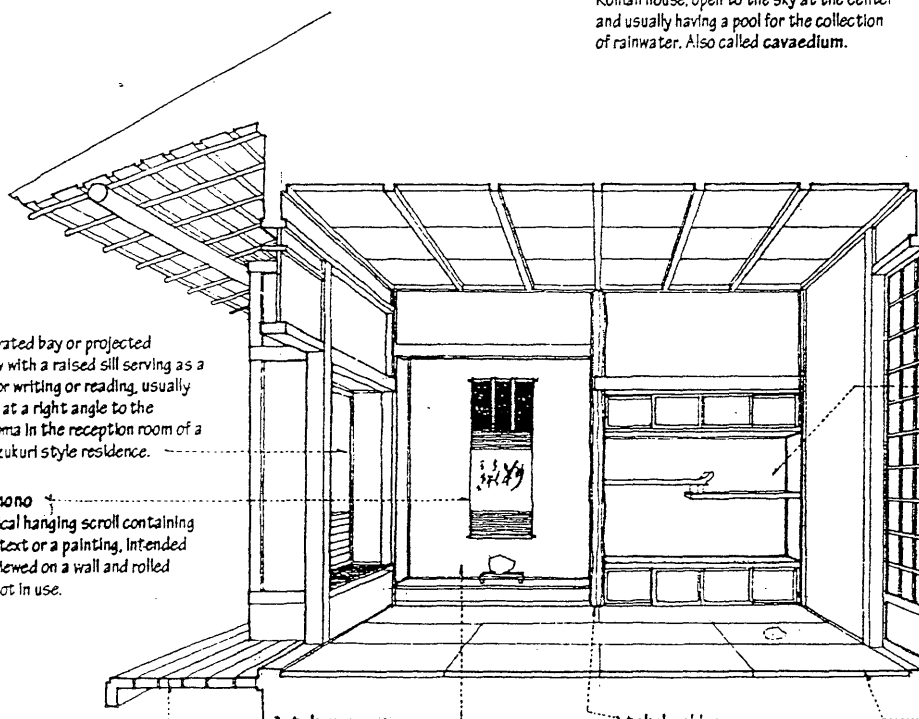
One of a series of sliding translucent panels used in Japanese architecture between the exterior and the interior, or between two interior spaces, consisting of a light wooden framework covered on one side with rice paper; the lower section is occasionally filled by a thin wooden panel.

**tatami**

A thick straw mat, covered with smooth, finely woven reeds and bound with plain or decorated bands of silk, cotton, or hemp, serving as a floor covering and a standard for designating room size in a traditional Japanese house. Tatami measured approximately 3 x 6 ft. (0.9 x 1.8 m), but varied in actual dimensions according to region and method for determining column spacing.

**ken**

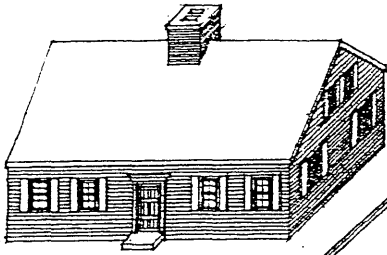
A linear unit for regulating column spacing in traditional Japanese construction, initially set at 6 ft. or 1.8 m, but later varying according to room width as determined by tatami units.



# HOUSE

## detached dwelling

A house having no wall in common with another house.



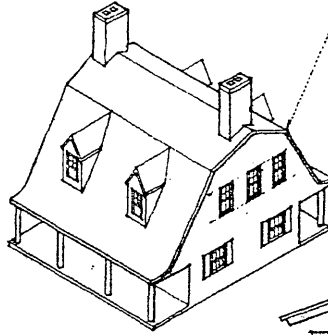
### Cape Cod

A style of cottage developed mainly on Cape Cod, Massachusetts, in the 18th and early 19th centuries, typically a rectangular, one- or one-and-a-half-story, wood-frame house with white clapboarded or shingle walls, a gable roof with low eaves and usually no dormer, a large central chimney, and a front door located on one of the long sides.



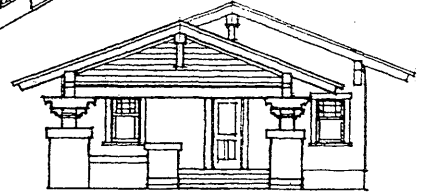
### saltbox

A type of wood-framed house found esp. in New England, generally two full stories high in front and one story high in back, the roof having about the same pitch in both directions so that the ridge is well toward the front of the house.



### Dutch Colonial

Of or pertaining to the domestic architecture of Dutch settlers in New York and New Jersey in the 17th century, often characterized by gambrel roofs having curved eaves over porches on the long sides.

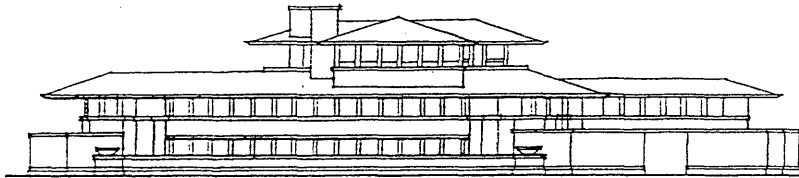


### bungalow

A derivative of the Indian bungalow, popular esp. in the first quarter of the 20th century, usually having one or one-and-a-half stories, a widely bracketed gable roof, a large porch, and often built of rustic materials.

### bungalow court

A group of three or more detached, one-story, single-family dwellings, arranged with common utilities and accessories under a common ownership.



### Prairie School

A group of early 20th-century architects, notably Frank Lloyd Wright, who designed houses and other buildings with emphasized horizontal lines responding to the flatness of the Midwestern prairie.

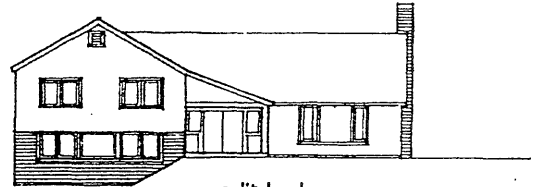


### rambler

A one-story house with a low-pitched roof, esp. one built in the suburbs.

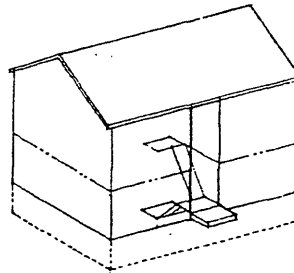
### tract house

A house forming part of a real-estate development, usually having a plan and appearance common to some or all of the houses in the development.



### split-level

A house having a room or rooms somewhat above or below adjacent rooms, with the floor levels usually differing by approximately half a story.



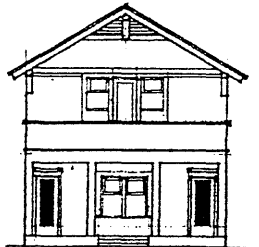
### bi-level

A two-story house having the lower level sunken below grade and an entry at grade halfway between the two floor levels.



### semidetached dwelling

A house joined by a party wall to another house or row of houses.

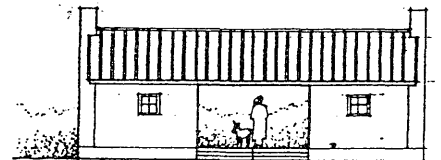


### duplex house

A house having separate apartments for two families, esp. a two-story house having a complete apartment on each floor and two separate entrances. Also called duplex.

### triplex

A building having three apartments, an apartment having three floors, or a multiplex of three theaters.



### dogtrot

A breezeway linking two parts of a house.

### breezeway

A porch or roofed passageway open on the sides, for connecting two buildings or parts of a building.

**condominium**

An apartment house, office building, or other multiple-unit complex, the units of which are individually owned, each owner receiving a recordable deed to the individual unit purchased, including the right to sell or mortgage that unit, and sharing in the joint ownership of any common elements, as hallways, elevators, mechanical and plumbing systems, or the like.

**cooperative**

A building owned and managed by a nonprofit corporation in which shares are sold, entitling the shareholders to occupy units in the building. Also called *co-op*, *cooperative apartment*.



**townhouse**

One of a row of houses in a city joined by common side walls.

**mew**

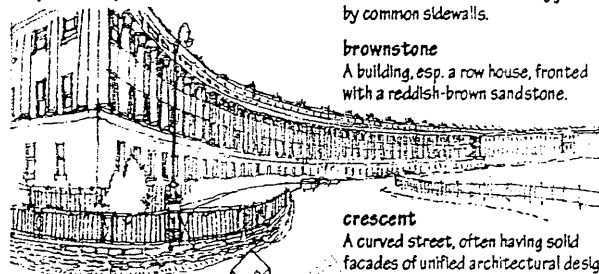
A street having small apartments converted from stables. Also, *mews*.

**row house**

One of a row of houses having at least one sidewall in common with a neighboring dwelling, and usually uniform or nearly uniform plans, fenestration, and architectural treatment.

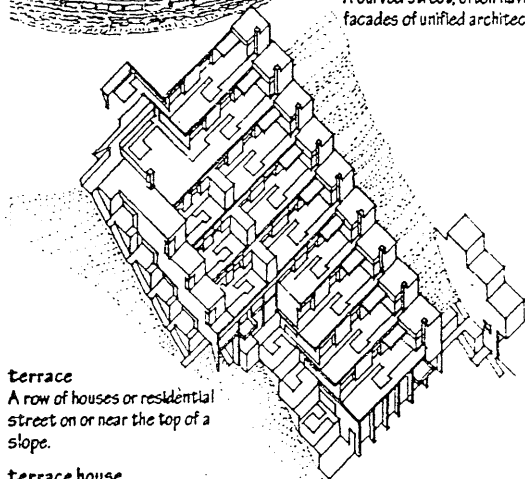
**brownstone**

A building, esp. a row house, fronted with a reddish-brown sandstone.



**crescent**

A curved street, often having solid facades of unified architectural design.



**terrace**

A row of houses or residential street on or near the top of a slope.

**terrace house**

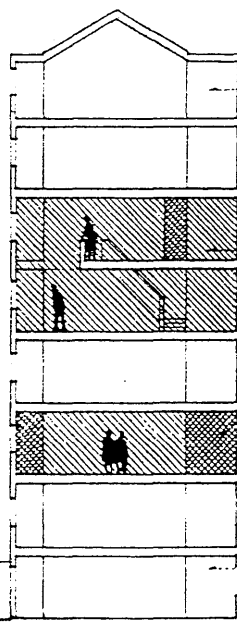
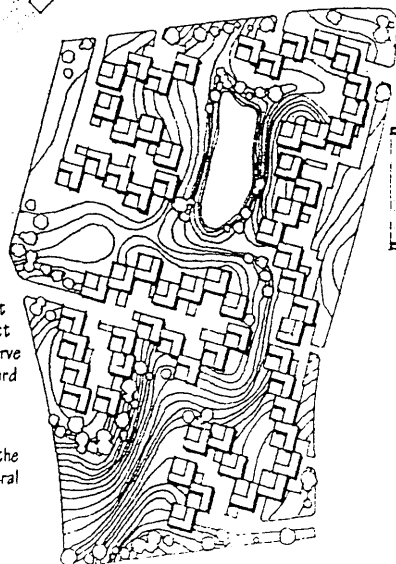
One of a row of houses situated on a terraced site.

**cluster housing**

A group of buildings and esp. houses built close together to form relatively compact units on a sizable tract in order to preserve open spaces larger than the individual yard for common recreation.

**commons**

A tract of land owned or used jointly by the residents of a community, usually a central square or park in a city or town.



**penthouse**

An apartment or residence on the top floor or roof of a building, often set back from the outer walls and opening onto a terrace.

**duplex apartment**

An apartment with rooms on two connected floors. Also called *duplex*.

**flat**

An apartment or suite of rooms on one floor forming a residence.

**walk-up**

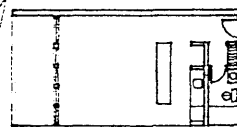
An apartment above the ground floor in a building that has no elevator.

**garden apartment**

An apartment on the ground floor of an apartment building having access to a backyard or garden.

**apartment house**

A building containing a number of apartment units. Also called *apartment building*.



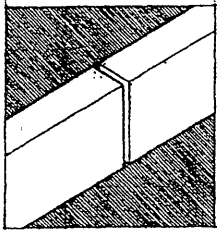
**studio apartment**

An apartment consisting of a single, multifunctional room, a kitchen or kitchenette, and a bathroom. Also called *efficiency apartment*.

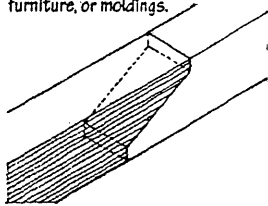
# JOINERY

The art or craft of forming joints, esp. in woodwork.

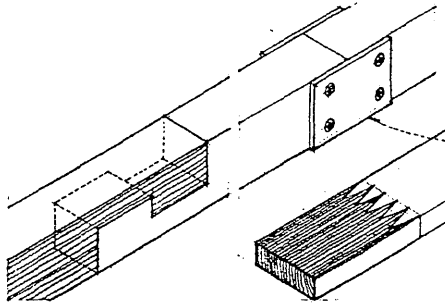
**woodwork**  
The work produced by the carpenter's and joiner's art, generally applied to objects or parts of a wooden structure, as stairways, furniture, or moldings.



**end joint**  
Any joint formed by uniting two members end to end so as to increase their length. Also called lengthening joint.



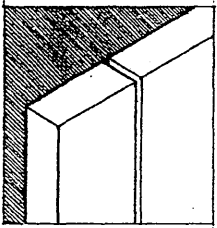
**scarf joint**  
A lengthening joint made by overlapping the tapered, notched, or halved ends of two members and holding them in place with bolts, straps, keys, or fishplates, to resist tension or compression.



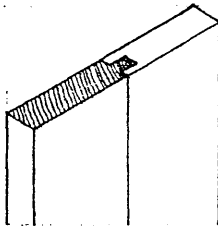
**square splice**  
A halved scarf joint used esp. to resist tension, having a thicker and a thinner section for each member, the thicker one being on the end.

**fish joint**  
A lengthening joint in which the abutting members are held in alignment and strengthened by fishplates.

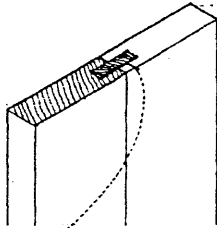
**fishplate**  
A metal plate bolted to each of two abutting members.



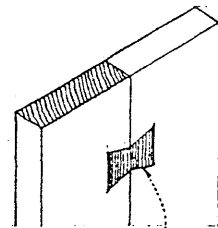
**edge joint**  
Any joint formed by uniting two members edge to edge so as to increase their width.



**tongue and groove**  
A joint made by fitting a raised area or tongue on the edge of one member into a corresponding groove in the edge of another member to produce a flush surface. Abbr.: T & G



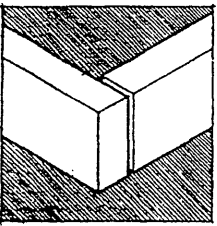
**spline**  
A thin strip of material inserted into the grooved edges of two members to make a butt joint between them. Also called feather.



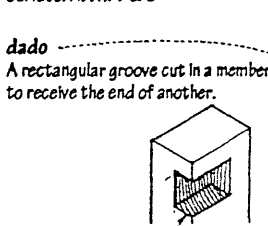
**butterfly wedge**  
A fastener in the form of a double dovetail for joining two members at their edges. Also called butterfly.

**butt joint**  
Any of various joints formed by abutting the surfaces of two members squarely together without overlapping.

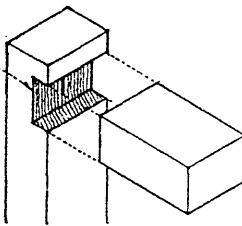
**flush joint**  
Any joint finished even or level with the surrounding surfaces.



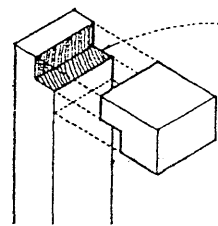
**angle joint**  
Any joint formed by uniting two members at a corner so as to change direction.



**dado**  
A rectangular groove cut in a member to receive the end of another.

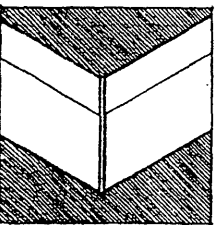


**dado joint**  
A joint made by inserting the end or edge of one member into a corresponding dado in the other. Also called housed joint.

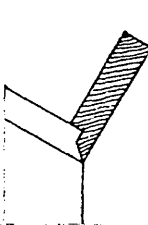


**rabbet**  
A channel, groove, or notch cut along or near one edge of a member so that something else can be fitted into it. Also, rebate.

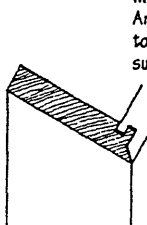
**roust**  
To groove or hollow out with a gouge or machine.



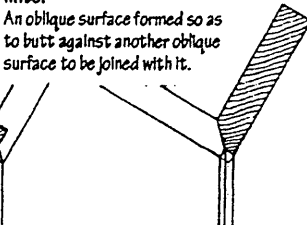
**miter joint**  
A joint between two members meeting at an angle, made by cutting each of the butting surfaces to an angle equal to half the angle of junction.



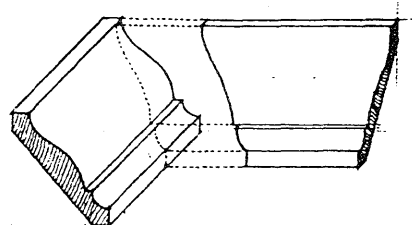
**shoulder miter**  
A miter joint having a raised surface to limit motion between the joined parts.



**tongued miter**  
A miter joint that incorporates a tongue and groove.



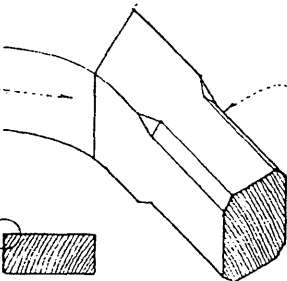
**quirk**  
An acute angle or groove separating one element from another.



**coped joint**  
A joint between two moldings made by undercutting the end of one of them to the profile of the other. Also called scribed joint.

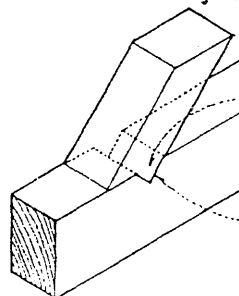
**easement**  
A curved joint forming a smooth transition between surfaces that would otherwise intersect at an angle.

**eased edge**  
A slightly rounded edge.



**stop chamfer**  
A chamfer that narrows gradually to merge with a sharp arris. Also, stopped chamfer.

**chamfer**  
A beveled surface, usually formed or cut at a 45° angle to the adjacent principal faces.

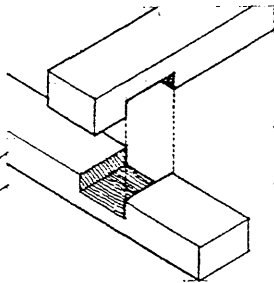
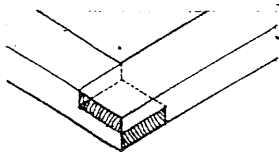


**joggle**  
A projection on one of two joining members fitting into a corresponding recess in the other to prevent slipping.

**dap**  
A notch cut in a timber to receive a timber connector or part of another timber.

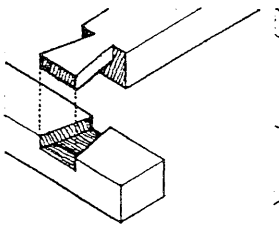
**halved joint**

A lap joint formed by cutting away half of each member at the place of joining so that a flush surface results. Also called half-lap joint.



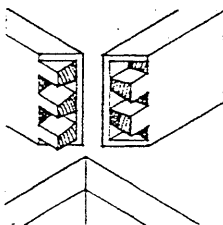
**end-lap joint**

An angle joint formed by halving each member for a length equal to the width of the other.



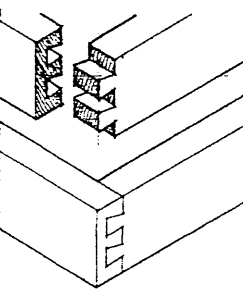
**cross-lap joint**

A halved joint formed by two crossing members.



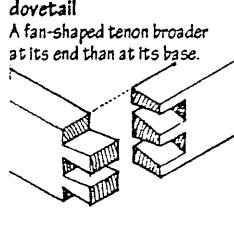
**mitered halving**

An end-lap joint incorporating a miter on one face.



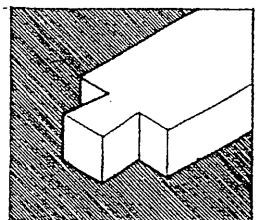
**plain lap**

A lap joint formed by overlapping two members without any change in form.



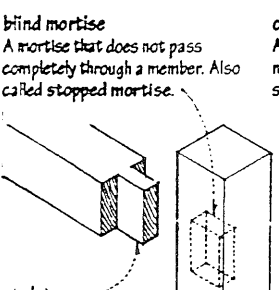
**lap joint**

Any of various joints formed by overlapping the ends or edges of two members.



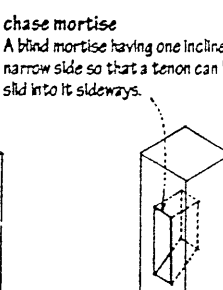
**dovetail halving**

A halved joint made by fitting a dovetail at the end of one member into a corresponding mortise in the second member.



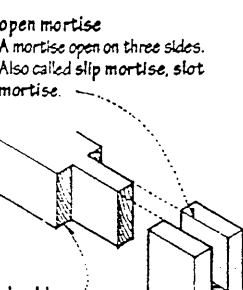
**secret dovetail**

A corner dovetail joint showing only the line of a miter. Also called miter dovetail.



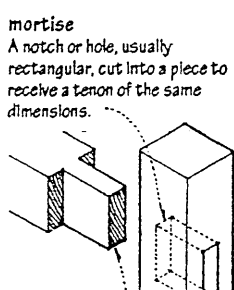
**lap dovetail**

A corner dovetail joint visible on one face only. Also called half-blind dovetail.



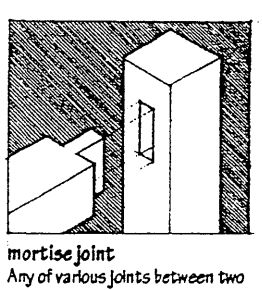
**common dovetail**

A corner dovetail joint visible on both faces.



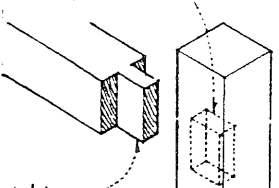
**dovetail joint**

A joint formed by one or more dovetails fitting tightly within corresponding mortises.



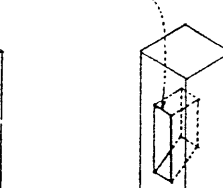
**blind mortise**

A mortise that does not pass completely through a member. Also called stopped mortise.



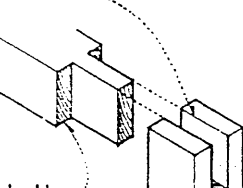
**chase mortise**

A blind mortise having one inclined narrow side so that a tenon can be slid into it sideways.



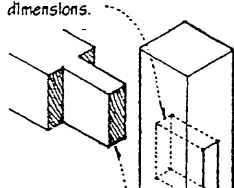
**open mortise**

A mortise open on three sides. Also called slip mortise, slot mortise.



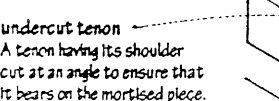
**mortise**

A notch or hole, usually rectangular, cut into a piece to receive a tenon of the same dimensions.



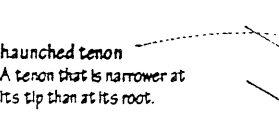
**stub tenon**

A short tenon for fitting into a blind mortise.



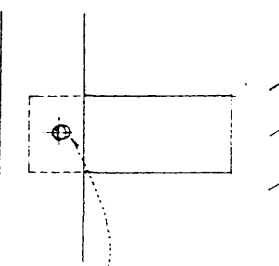
**undercut tenon**

A tenon having its shoulder cut at an angle to ensure that it bears on the mortised piece.



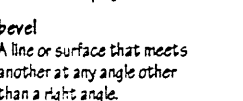
**haunched tenon**

A tenon that is narrower at its tip than at its root.



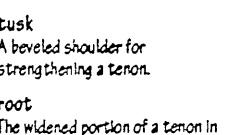
**shoulder**

The end surface from which a tenon projects.



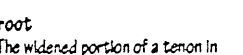
**bevel**

A line or surface that meets another at any angle other than a right angle.



**tusk**

A beveled shoulder for strengthening a tenon.



**root**

The widened portion of a tenon in the plane of the shoulders.



**gain**

A notch, dado, or mortise cut into a member to receive another part.



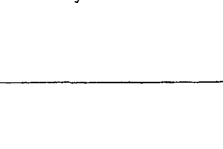
**drawbore**

A hole in a tenon bored eccentric with the corresponding holes in the mortise so that the two pieces being joined will be forced tightly together when the drawbore pin is hammered into place.



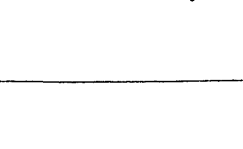
**bridle joint**

A joint formed by fitting the end of one member, notched to form two parallel tenons, into two gains cut into the edge of a second member.



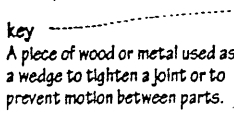
**foxtail wedge**

A small wedge in the split end of a stub tenon for spreading and securing it when driven into a blind mortise. Also called fox wedge.



**through tenon**

A tenon that extends completely through or beyond the piece into which its corresponding mortise is cut.



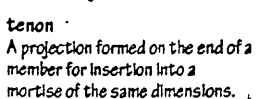
**key**

A piece of wood or metal used as a wedge to tighten a joint or to prevent motion between parts.



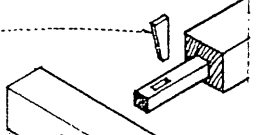
**mortise joint**

Any of various joints between two members made by housing a tenon in a mortise. Also called mortise-and-tenon joint.



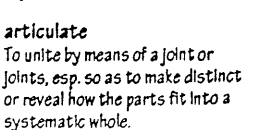
**tenon**

A projection formed on the end of a member for insertion into a mortise of the same dimensions.



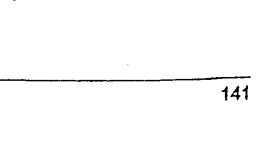
**keyed joint**

A joint fastened or secured by a key.



**articulate**

To unite by means of a joint or joints, esp. so as to make distinct or reveal how the parts fit into a systematic whole.

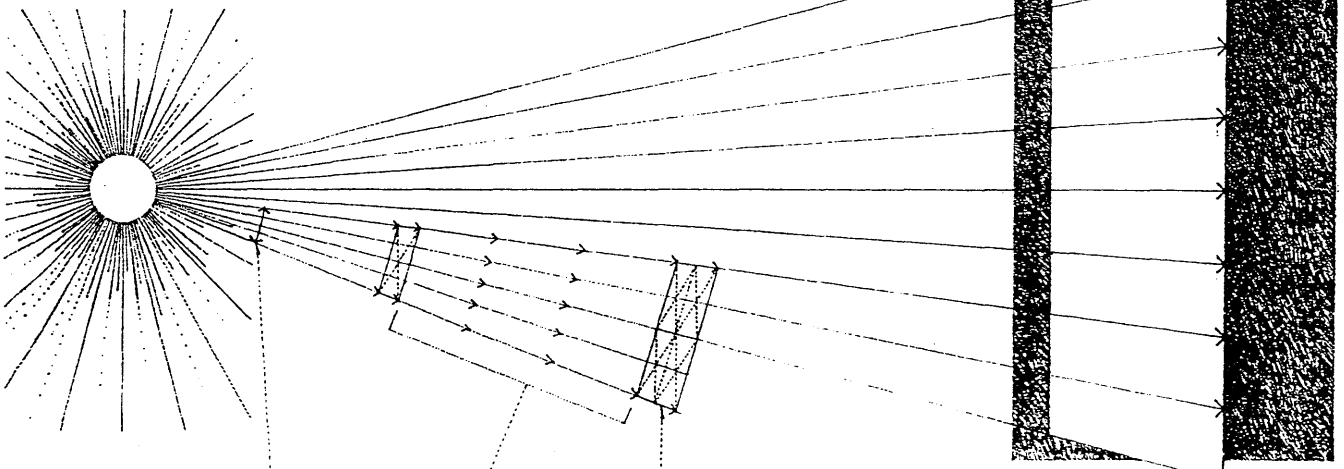
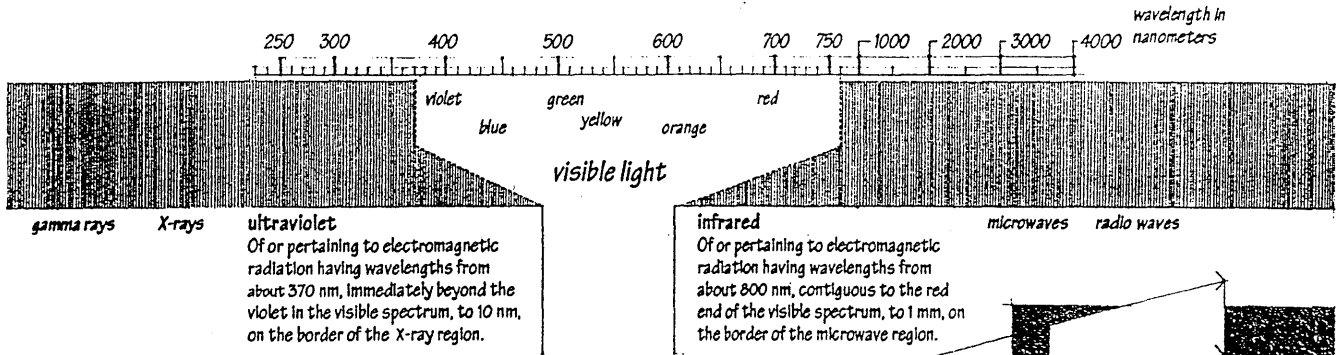


# LIGHT

Electromagnetic radiation that the unaided human eye can perceive, having a wavelength in the range from about 370 to 800 nm and propagating at a speed of 186,281 mi./sec (299,972 km/sec).

**nanometer**  
A unit of length equal to one billionth of a meter, used esp. to express the wavelengths of light in or near the visible spectrum. Abbr.: nm

**angstrom**  
A unit of length equal to one ten-billionth of a meter, used esp. to express the wavelengths of radiation. Symbol: Å



**luminous intensity**  
The luminous flux emitted per unit solid angle by a light source, expressed in candelas.

**candlepower**  
Luminous intensity expressed in candelas.

**candle**  
A unit of luminous intensity used prior to 1948, equal to the luminous intensity of a wax candle of standard specifications.

**candela**  
The basic SI unit of luminous intensity, equal to the luminous intensity of a source that emits monochromatic radiation of frequency  $540 \times 10^{12}$  hertz and that has a radiant intensity of  $\frac{1}{683}$  watt per steradian. Also called standard candle. Abbr.: Cd

**solid angle**  
An angle formed by three or more planes intersecting at a common point.

**steradian**  
A solid angle at the center of a sphere subtending an area on the surface equal to the square of the radius of the sphere. Abbr.: sr

**luminous flux**  
The rate of flow of visible light per unit time, expressed in lumens.

**lumen**  
The SI unit of luminous flux, equal to the light emitted in a solid angle of one steradian by a uniform point source having an intensity of one candela. Abbr.: lm

**cosine law**  
The law that the illumination produced on a surface by a point source is proportional to the cosine of the angle of incidence. Also called Lambert's law.

**inverse square law**  
One of several laws relating two quantities such that one quantity varies inversely as the square of the other, as the law that the illumination produced on a surface by a point source varies inversely as the square of the distance of the surface from the source.

**illumination**  
The intensity of light falling at any given place on a lighted surface, equal to the luminous flux incident per unit area and expressed in lumens per unit of area. Also called illuminance.

**lux**  
The SI unit of illumination, equal to one lumen per square meter. Abbr.: lx

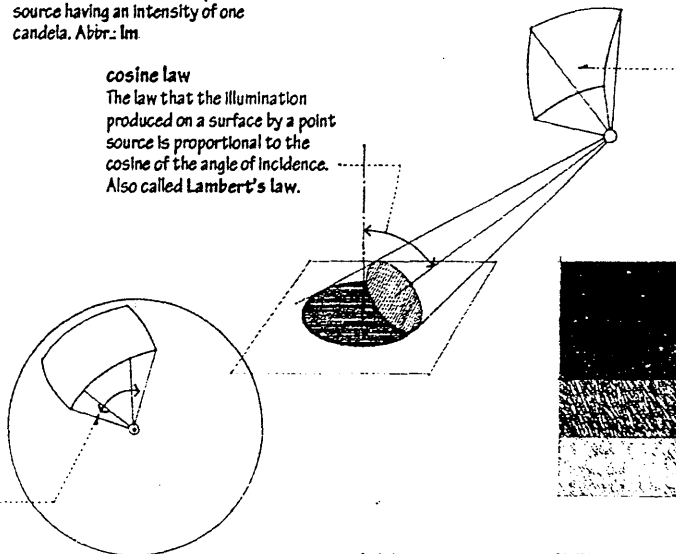
**foot-candle**  
A unit of illumination on a surface that is everywhere one foot from a uniform point source of one candela and equal to one lumen incident per square foot. Abbr.: FC

**luminance**  
The quantitative measure of brightness of a light source or an illuminated surface, equal to the luminous intensity per unit projected area of the source or surface viewed from a given direction.

**lambert**  
A unit of luminance or brightness equal to 0.32 candela per square centimeter. Abbr.: L

**foot-lambert**  
A unit of luminance or brightness equal to 0.32 candela per square foot. Abbr.: fL

**brightness**  
The sensation by which an observer is able to distinguish between differences in luminance.



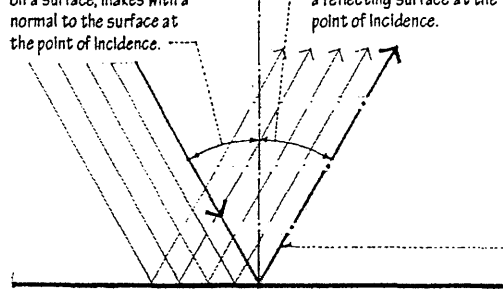
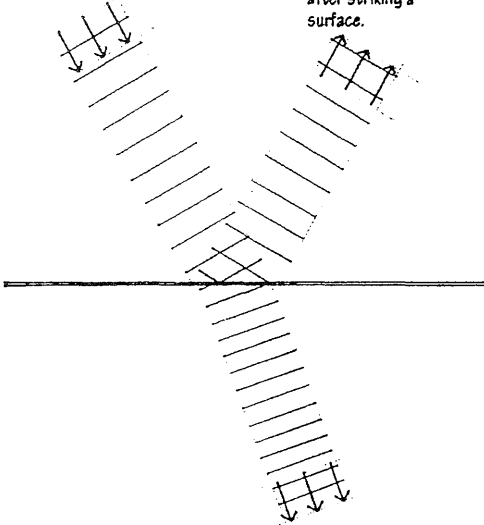
**incidence**  
The striking of a ray of light or sound wave on a surface.

**reflection**  
The return of light, sound, or radiant heat after striking a surface.

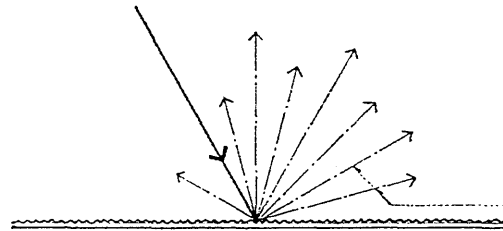
**angle of incidence**  
The angle that a straight line, as a ray of light falling on a surface, makes with a normal to the surface at the point of incidence.

**angle of reflection**  
The angle that a reflected ray makes with a normal to a reflecting surface at the point of incidence.

**law of reflection**  
The principle that when light or sound is reflected from a smooth surface, the angle of incidence is equal to the angle of reflection, and the incident ray, the reflected ray, and the normal to the surface all lie in the same plane.



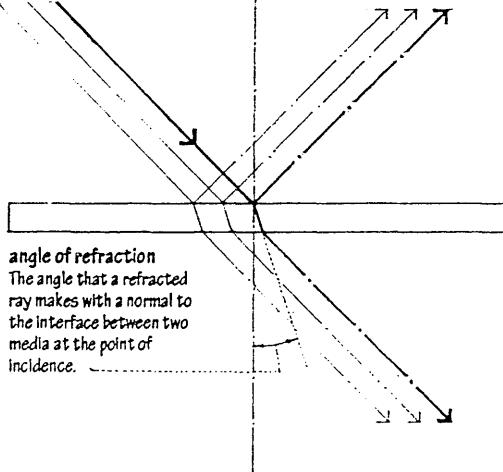
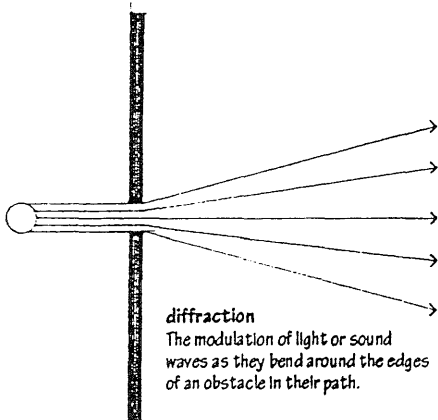
**specular**  
Directed from a smooth, polished surface.



**diffusion**  
A scattered reflection of light from an irregular surface or an erratic dispersion through a translucent material.

**diffuse**  
Dispersed from an irregular surface.

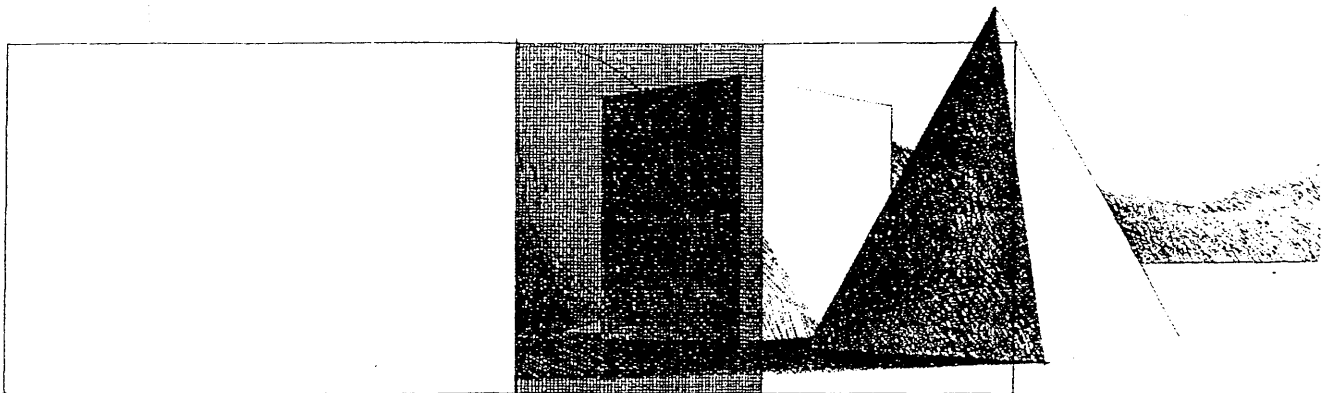
**refraction**  
The change of direction of a ray of light as it passes obliquely from one medium into another in which its velocity is different.



**reflectance**  
The ratio of the radiation reflected by a surface to the total incident on the surface.

**absorbance**  
The ratio of the radiation absorbed by a surface to the total incident on the surface.

**transmittance**  
The ratio of the radiation transmitted through and emerging from a body to the total incident on it, equivalent to one minus the absorbance.



**opaque**  
Impenetrable to light.

**translucent**  
Transmitting and diffusing light so that bodies on the opposite side are not clearly visible.

**transparent**  
Capable of transmitting light so that bodies situated beyond or behind can be distinctly seen.

# LIGHT

**Lamp**  
Any of various devices for producing light or heat, as by electricity or gas.

**incandescent lamp**  
A lamp in which a filament gives off light when heated to incandescence by an electric current. Also called light bulb.

**filament**  
The threadlike conductor of an electric lamp that is heated to incandescence by the passage of an electric current.

**incandescence**  
The emission of visible light by a body when heated to a high temperature.

**extended-service lamp**  
A lamp designed for reduced energy consumption and a life longer than the conventionally set value for its general class. Also called long-life lamp.

**efficacy**  
A measure of the effectiveness with which a lamp converts electric power into luminous flux, equal to the ratio of flux emitted to power input and expressed in lumens per watt.

**rated life**  
The average life in hours of a given type of lamp, based on laboratory tests of a representative group under controlled conditions.

**three-way lamp**  
An incandescent lamp having two filaments so that it can be switched to three successive degrees of illumination.

**tungsten lamp**  
An incandescent lamp having a tungsten filament.

**tungsten-halogen lamp**  
A tungsten lamp having a quartz bulb containing a small amount of a halogen that vaporizes on heating and redeposits any evaporated tungsten particles back onto the filament. Also called halogen lamp, quartz lamp.

**IR lamp**  
A tungsten-halogen lamp having an infrared dichroic coating for reflecting infrared energy back to the filament, raising lamp efficiency, and reducing radiant heat in the emitted light beam.

**infrared lamp**  
An incandescent lamp having a higher percentage of its radiant power in the infrared region than a standard incandescent lamp, often having a red glass bulb to reduce the radiated visible light.

**bulb**  
The glass housing of an incandescent lamp, filled with an inert gas mixture, usually of argon and nitrogen, to retard evaporation of the filament. Its shape is designated by a letter, followed by a number that indicates the lamp diameter.

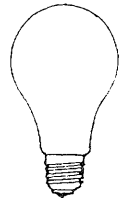
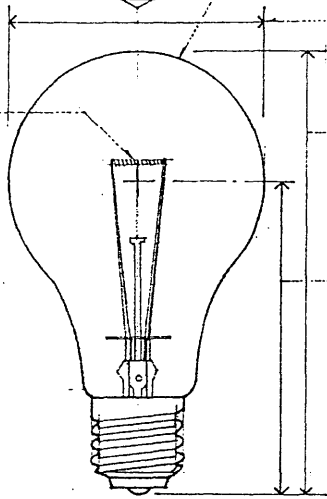
**lamp diameter**  
The maximum diameter of a lamp bulb, measured in eighths of an inch.

**maximum overall length**  
The dimension in inches from the base of a lamp to the point on the bulb farthest away, or the base-to-base dimension of a lamp having a base at each end.

**light center length**  
The distance in inches from the center of the filament of a lamp and a reference plane on the lamp base.

**lamp base**  
The part of a lamp that connects to a lamp holder.

**lamp holder**  
A device for mechanically supporting and making electrical contact with a lamp. Also called lamp socket.



**A bulb**  
The standard rounded shape for the bulbs of general-service incandescent lamps.



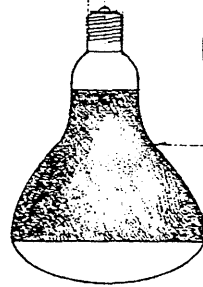
**B bulb**  
A flame-shaped bulb for low-wattage, decorative incandescent lamps.



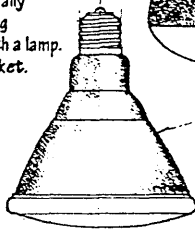
**C bulb**  
A cone-shaped bulb for low-wattage, decorative incandescent lamps.



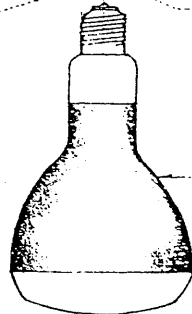
**CA bulb**  
A candle-shaped bulb for low-wattage, decorative incandescent lamps.



**R bulb**  
A reflector bulb of blown glass for incandescent and high-intensity-discharge lamps, having an internal reflective coating and either a clear or frosted glass front to provide the desired beam spread.



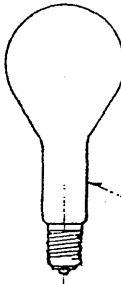
**PAR bulb**  
A parabolic aluminized reflector bulb of cast glass for incandescent and high-intensity-discharge lamps, having a precisely formed internal reflector and a lensed front to provide the desired beam spread.



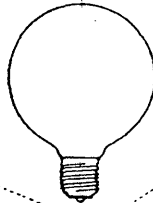
**ER bulb**  
An ellipsoidal reflector bulb for incandescent lamps, having a precisely formed internal reflector that collects light and redirects it into a dispersed pattern at some distance in front of the light source.



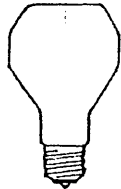
**A/5B bulb**  
An A bulb having a hemispherical, reflective silver bowl opposite the lamp base to decrease glare.



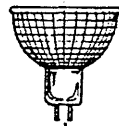
**G bulb**  
A globe-shaped bulb for incandescent lamps, having a low brightness for exposed use.



**PS bulb**  
A pear-shaped bulb for large incandescent lamps.



**S bulb**  
A straight-sided bulb for low-wattage, decorative incandescent lamps.



**MR bulb**  
A multifaceted reflector bulb for tungsten-halogen lamps, having highly polished reflectors arranged in discrete segments to provide the desired beam spread.

**TB bulb**  
A quartz bulb for tungsten-halogen lamps, similar in shape to the A bulb but having an angular profile.



**ballast**

A device for maintaining the current through a fluorescent or HID lamp at the desired constant value, and sometimes also providing the required starting voltage and current.

**starter**

A device used with a ballast to provide the starting voltage for a preheat fluorescent lamp.

**T bulb**

A tubular bulb for incandescent, fluorescent, and high-intensity-discharge lamps.

**circulene lamp**

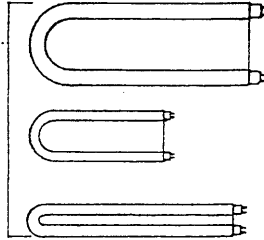
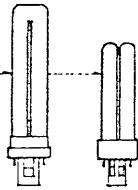
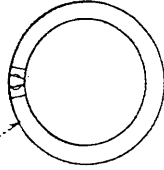
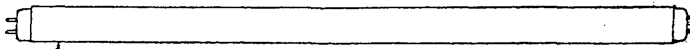
A doughnut-shaped fluorescent lamp for circular luminaires.

**U-bent lamp**

A U-shaped fluorescent lamp for square or rectangular luminaires.

**compact fluorescent lamp**

Any of various small, improved efficiency fluorescent lamps having a single, double, or U-shaped tube, and often an adapter for fitting an incandescent lampholder.



**phosphor**

Any of a number of substances that emit light when excited by radiation.

**triposphor**

A phosphor having peaks in three specific color regions, red, blue, and green, used to improve the color rendering of a fluorescent lamp.

**discharge lamp**

A lamp in which light is produced by the discharge of electricity between electrodes in a gas-filled glass enclosure.

**fluorescent lamp**

A tubular discharge lamp in which light is produced by the fluorescence of phosphors coating the inside of the tube.

**fluorescence**

The emission of radiation, esp. of visible light, by a substance during exposure to external radiation.

**preheat lamp**

A fluorescent lamp that requires a separate starter to preheat the cathodes before opening the circuit to the starting voltage.

**rapid-start lamp**

A fluorescent lamp designed to operate with a ballast having a low-voltage winding for continuous heating of the cathodes, which allows the lamp to be started more rapidly than a preheat lamp.

**instant-start lamp**

A fluorescent lamp designed to operate with a ballast having a high-voltage transformer to initiate the arc directly without any preheating of the cathodes.

**high-output lamp**

A rapid-start fluorescent lamp designed to operate on a current of 800 milliamperes, resulting in a corresponding increase in luminous flux per unit length of lamp.

**very-high-output lamp**

A rapid-start fluorescent lamp designed to operate on a current of 1500 milliamperes, providing a corresponding increase in luminous flux per unit length of lamp.

**color temperature**

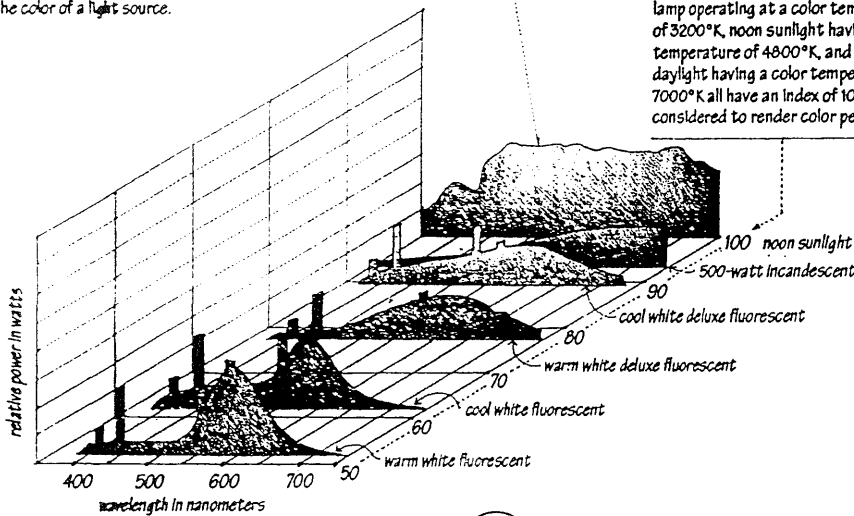
The temperature at which a blackbody emits light of a specified spectral distribution, used to specify the color of a light source.

**spectral distribution curve**

A curve plotting the radiant energy in each wavelength of a particular light source.

**color rendering index**

A measure of the ability of an electric lamp to render color accurately when compared with a reference light source of similar color temperature. A tungsten lamp operating at a color temperature of 3200°K, noon sunlight having a color temperature of 4800°K, and average daylight having a color temperature of 7000°K all have an index of 100 and are considered to render color perfectly.



**high-intensity discharge lamp**

A discharge lamp in which a significant amount of light is produced by the discharge of electricity through a metallic vapor in a sealed glass enclosure. Also, HID lamp.

**mercury lamp**

A high-intensity discharge lamp producing light by means of an electric discharge in mercury vapor. Also called mercury-vapor lamp.

**sodium lamp**

A high-intensity discharge lamp producing light by means of an electric discharge in sodium vapor. Also called sodium-vapor lamp.

**low-pressure sodium lamp**

A sodium lamp producing a yellow, glareless light and used esp. to illuminate roadways. Also, LPS lamp.

**high-pressure sodium lamp**

A sodium lamp producing a broader-spectrum, golden-white light than a low-pressure sodium lamp. Also, HPS lamp.

**metal halide lamp**

A high-intensity discharge lamp similar in construction to a mercury lamp, but having an arc tube to which various metal halides are added to produce more light and improve color rendering.

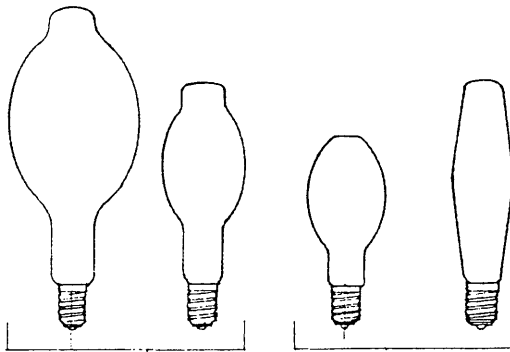


**neon lamp**

A cold-cathode lamp emitting a glow when a high voltage is applied across two electrodes in a neon-filled glass tube.

**cold-cathode lamp**

A discharge lamp having cathodes that emit electrons without having to be heated.



**BT bulb**

A bulged tubular bulb for high-intensity-discharge lamps.

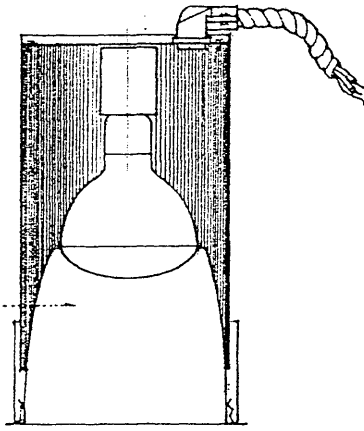
**E bulb**

An ellipsoidal bulb for high-intensity-discharge lamps.

# LIGHT

## luminaire

A lighting unit consisting of one or more electric lamps with all of the necessary parts and wiring for positioning and protecting the lamps, connecting the lamps to a power supply, and distributing the light. Also called lighting fixture.

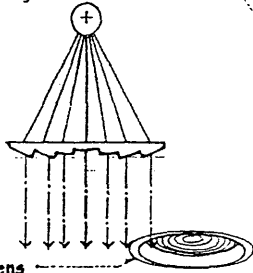


## reflector

A surface for reflecting light, heat, or sound, esp. the device on a luminaire having such a surface for controlling the distribution of light emitted by a lamp.

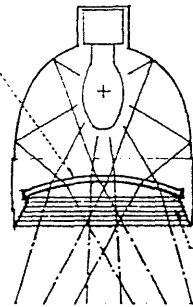
## lens

A piece of transparent material, as glass or plastic, having two opposite surfaces either or both of which are curved, used in luminaires to focus, disperse, or collimate the emitted light.



## Fresnel lens

A lens having concentric, prismatic grooves to concentrate light from a small source.

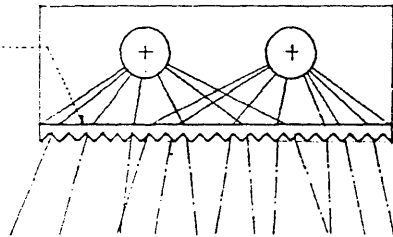


## ridged baffle

A series of circular ridges for reducing the brightness of a light source at an aperture.

## prismatic lens

A lens having a multifaceted surface with parallel prisms to redirect the rays from a light source.

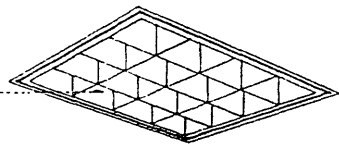


## louver

A finned or vaned device for controlling the radiation from a light source.

## eggcrate

A louvered construction divided into cell-like areas and used for redirecting the light emitted by an overhead source.

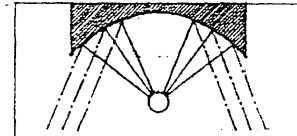
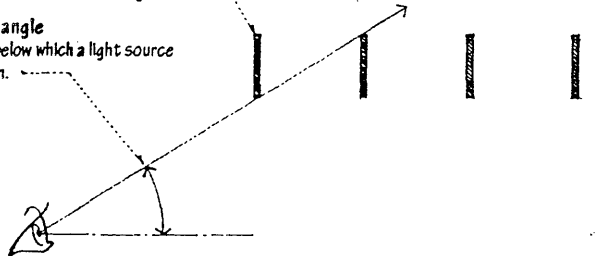


## baffle

A louvered device for shielding a light source from view at certain angles.

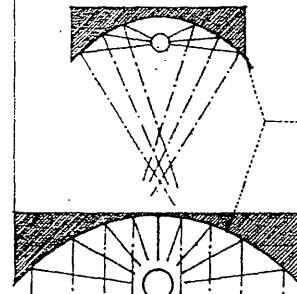
## shielding angle

The angle below which a light source can be seen.



## parabolic reflector

A reflector having a parabolic surface to collimate, spread, or focus the rays from a light source, depending on the location of the source.



## collimate

To make rays of light parallel.

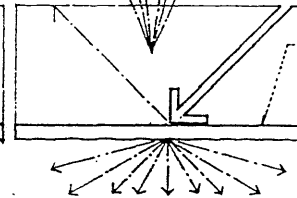


## elliptical reflector

A reflector having an elliptical surface to focus the rays from a light source.

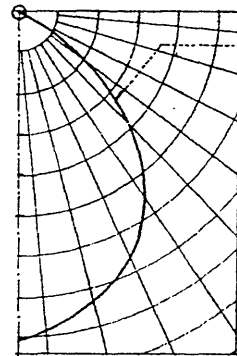
## diffuser

Any of a variety of translucent materials for filtering glare from a light source and distributing the light over an extended area.



## candlepower distribution curve

A polar plot of the luminous intensity emitted by a lamp, luminaire, or window in a given direction from the center of the light source, measured in a single plane for a symmetrical light source, and in a perpendicular, parallel, and sometimes a 45° plane for an asymmetrical source.

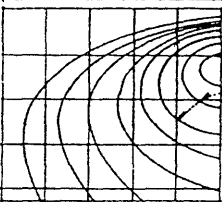


## isochart

A graphic plot of the pattern of illumination produced on a surface by a lamp or luminaire.

## isolux line

A line through all points on a surface where the level of illumination is the same. Called isofootcandle line if illumination is expressed in footcandles.



## luminaire efficiency

The ratio of luminous flux emitted by a luminaire to the total flux emitted by the lamps in the luminaire.

**wall washer**

A downlight mounted close to the plane of a wall and equipped with a reflector, baffle, or lens to illuminate the vertical surface.

**floodlight**

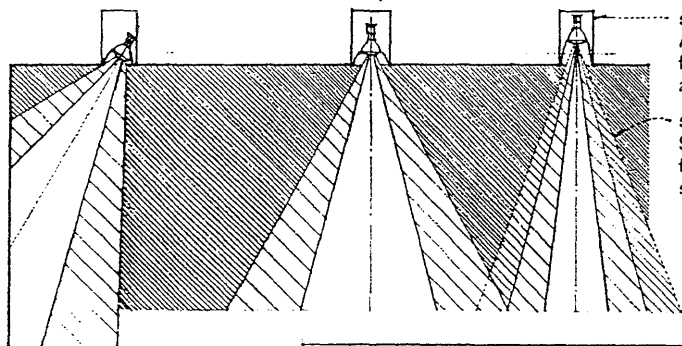
A lamp designed to project or diffuse a comparatively uniform level of illumination over a large area. Also called flood, flood lamp.

**downlight**

A luminaire consisting of a lamp set in a metal cylinder, recessed into or mounted on a ceiling to direct a beam of light downward.

**point source**

A light source having a maximum dimension less than one fifth the distance from the source to the surface illuminated.

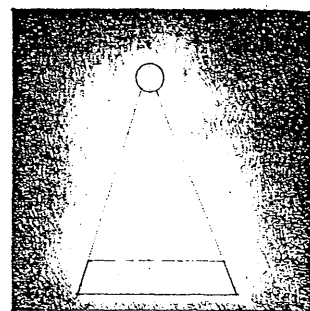


**spotlight**

A lamp designed to project a strong, focused beam of light on an object or area. Also called spot.

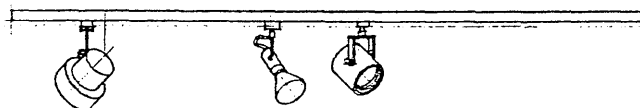
**spill**

Superfluous or useless light rays, as from a spotlight or other focused light source. Also called spill light.



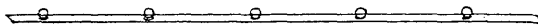
**track lighting**

Lighting provided by adjustable spotlights mounted along a narrow, ceiling- or wall-mounted metal track through which current is conducted.



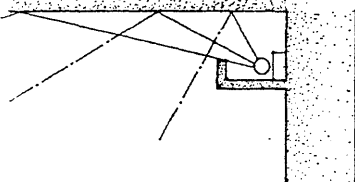
**light strip**

A rigid or flexible tape with exposed low-voltage light sources of 1 to 10 watts.



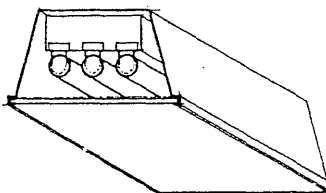
**cove lighting**

Indirect lighting directed upward from an interior cornice at the edge of a ceiling.



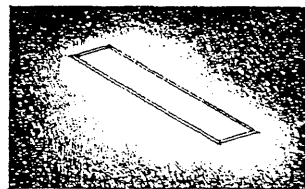
**troffer**

A luminaire having a trough-shaped reflector holding one or more fluorescent lamps.



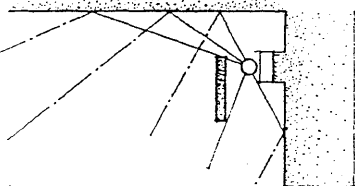
**linear source**

A light source having one dimension significantly greater than its other dimensions, as a fluorescent lamp.



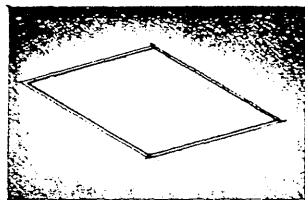
**valance lighting**

Indirect lighting directed upward or downward from a light source concealed by a horizontal board or band.



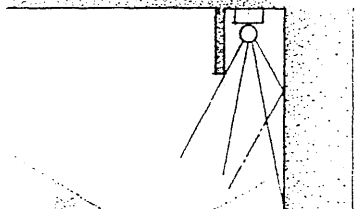
**area source**

A light source having significant dimensions in two directions, as a large window or a luminous ceiling.



**cornice lighting**

Indirect lighting directed downward from an interior cornice at the edge of a ceiling.

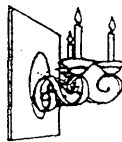
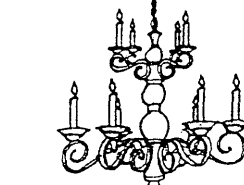
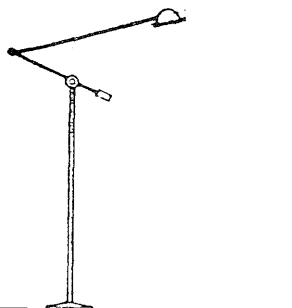
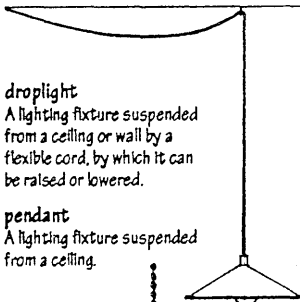


**droplight**

A lighting fixture suspended from a ceiling or wall by a flexible cord, by which it can be raised or lowered.

**pendant**

A lighting fixture suspended from a ceiling.



**bridge lamp**

A floor lamp having the light source on a hinged, horizontally adjustable arm.

**torchiere**

A floor lamp having its light source within a reflecting bowl that directs the light upward. Also, torchère, torchier.

**chandelier**

A decorative lighting fixture suspended from a ceiling, usually having branched supports for a number of lamps.

**sconce**

A decorative wall bracket for candles or other lights.

**gooseneck lamp**

A desk lamp having a flexible shaft resembling the neck of a goose.

# LIGHT

## lighting

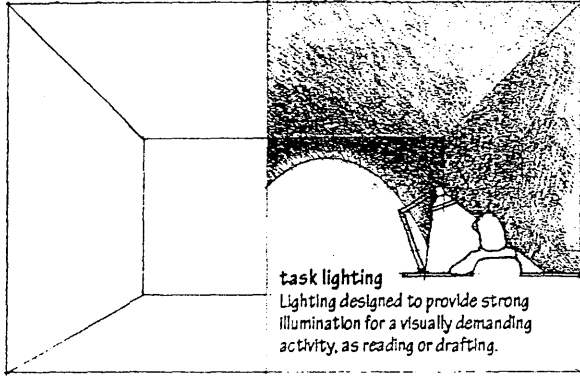
The science, theory, or method of providing illumination through the use of electric lamps.

### general lighting

Lighting designed to provide a uniform level of illumination throughout an area.

### local lighting

Lighting designed to provide a relatively high level of illumination over a small area, with a surrounding area of lower intensity from spill light.

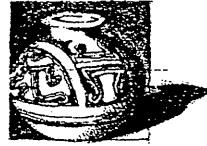


### task lighting

Lighting designed to provide strong illumination for a visually demanding activity, as reading or drafting.

### accent lighting

Lighting that calls attention to a particular object or feature in the visual field, or that forms a decorative pattern on a surface.



### highlight

To emphasize by illuminating with a strong light.



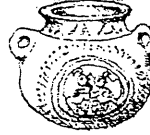
### backlight

To illuminate something from behind in order to enhance depth or to separate the subject from its background.



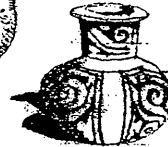
### sidelight

Light coming or produced from the side.



### soft light

Diffuse light that produces little contrast and poorly defined shadows on the subject.

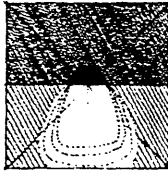


### hard light

Direct light that produces high contrast and distinct shadows on the subject.

### direct lighting

Lighting in which luminaires distribute 90% to 100% of the emitted light downward on the surface or area to be illuminated.



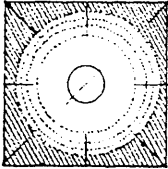
### semidirect lighting

Lighting in which luminaires distribute 60% to 90% of the emitted light downward.



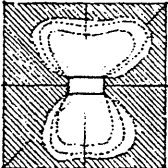
### general diffuse lighting

Lighting from luminaires that emit an approximately equal distribution of light upward and downward.



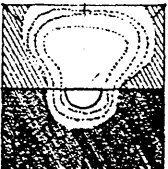
### direct-indirect lighting

General diffuse lighting in which little light is emitted in the horizontal plane of the luminaires.



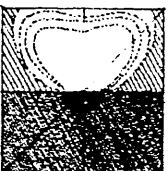
### semi-indirect lighting

Lighting in which luminaires distribute 60% to 90% of the emitted light upward.



### indirect lighting

Lighting in which luminaires distribute 90% to 100% of the emitted light upward, esp. to avoid glare or prevent shadows.



### glare

The sensation produced by any brightness within the visual field that is sufficiently greater than the luminance to which the eyes are adapted to cause annoyance, discomfort, or loss of visibility.

### adaptation

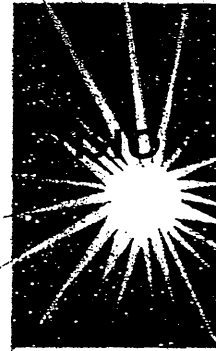
The regulating by the pupil of the quantity of light entering the eye, resulting in a change in the sensitivity of the eye's photoreceptors to light.

### visual comfort probability

A rating of the likelihood that a lighting system will not cause direct glare, expressed as the percentage of people who may be expected to experience visual comfort when seated in the least favorable visual position.

### brightness ratio

The ratio between the luminance of an object and that of its background. Also called contrast ratio.



### blinding glare

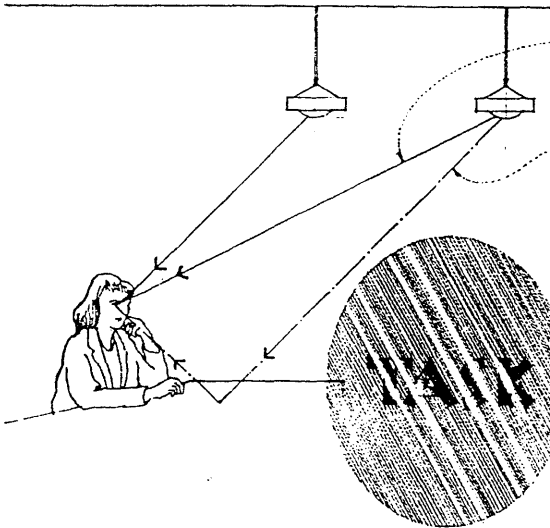
Glare so intense that, for an appreciable length of time after it has been removed, visibility is lost.

### disability glare

Glare that reduces visibility or impairs visual performance, often accompanied by discomfort.

### discomfort glare

Glare that produces discomfort but does not necessarily interfere with visibility or visual performance.



### direct glare

Glare resulting from a high brightness ratio or an insufficiently shielded light source in the visual field.

### reflected glare

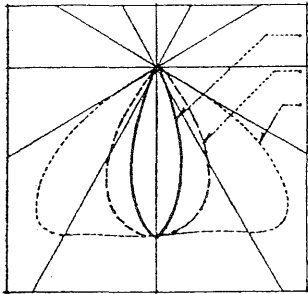
Glare resulting from the specular reflection of a light source within the visual field. Also called indirect glare.

### veiling reflectance

Reflected glare on a task surface that reduces the contrast necessary for seeing details.

**beam spread**

The angle of a light beam that intersects the candlepower distribution curve at points where the luminous intensity equals a stated percent of a maximum reference intensity.



**beam**

A group of nearly parallel rays of light.

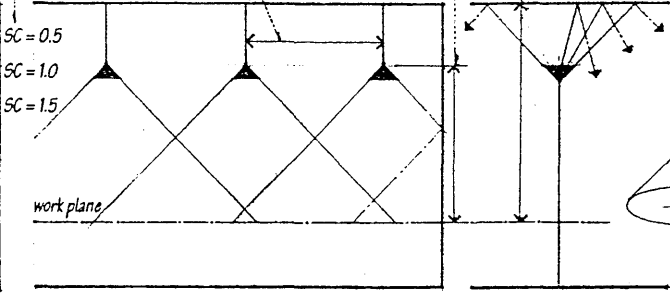
**throw**

The effective length of a beam of light.

**spacing criteria**

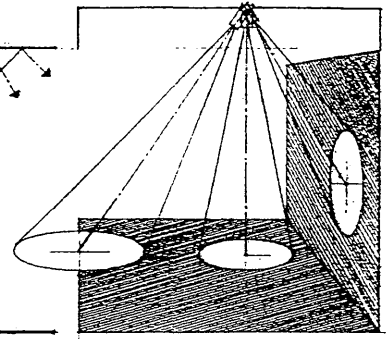
A formula for determining how far apart luminaires may be installed for uniform lighting of a surface or area, based on mounting height.

$$\text{spacing criteria (sc)} = \text{spacing (s)} / \text{mounting height (mh)}$$



**point method**

A procedure for calculating the illumination produced on a surface by a point source from any angle, based on the inverse square and cosine laws.



**ceiling cavity**

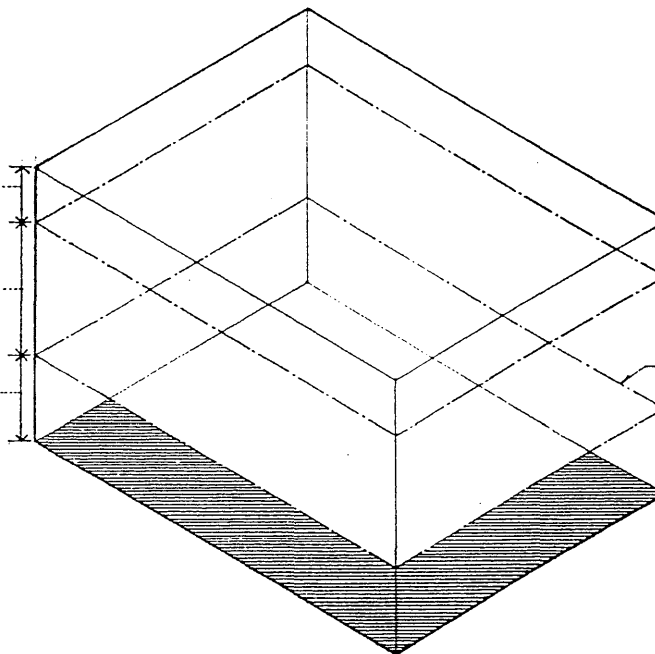
The cavity formed by the ceiling, a plane of suspended luminaires, and the wall surfaces between these two planes.

**room cavity**

The cavity formed by a plane of luminaires, the work plane, and the wall surfaces between these two planes.

**floor cavity**

The cavity formed by the work plane, the floor, and the wall surfaces between these two planes.



**lumen method**

A procedure for determining the number and types of lamps, luminaires, or windows required to provide a uniform level of illumination on a work plane, taking into account both direct and reflected luminous flux. Also called zonal cavity method.

**work plane**

The horizontal plane at which work is done and on which illumination is specified and measured, usually assumed to be 30 in. (762 mm) above the floor.

**room cavity ratio**

A single number derived from the dimensions of a room cavity for use in determining the coefficient of utilization.

**light loss factor**

Any of several factors used in calculating the effective illumination provided by a lighting system after a given period of time and under given conditions. Formerly called maintenance factor.

**coefficient of utilization**

The ratio of the luminous flux reaching a specified work plane to the total lumen output of a luminaire, taking into account the proportions of a room and the reflectances of its surfaces.

**recoverable light loss factor**

A light loss factor that may be recovered by relamping or maintenance, as lamp lumen depreciation, luminaire dirt depreciation, and room surface dirt depreciation.

**lamp lumen depreciation**

A light loss factor representing the decrease in luminous output of a lamp during its operating life, expressed as a percentage of initial lamp lumens.

**luminaire dirt depreciation**

A light loss factor representing the decrease in luminous output of a luminaire resulting from the accumulation of dirt on its surfaces, expressed as a percentage of the illumination from the luminaire when new or clean.

**room surface dirt depreciation**

A light loss factor representing the decrease in reflected light resulting from the accumulation of dirt on a room's surfaces, expressed as a percentage of the light reflected from the surfaces when clean.

$$\text{average maintained illuminance} = \frac{\text{initial lamp lumens} \times \text{CU} \times \text{RLLF} \times \text{NRLLF}}{\text{work area}}$$

$$\text{initial lamp lumens} = \text{lumens per lamp} \times \text{lamps per luminaire}$$

**nonrecoverable light loss factor**

Any of several permanent light loss factors that take into account the effects of temperature, voltage drops or surges, ballast variations, and partition heights.

# LIGHT

## daylighting

The science, theory, or method of providing illumination through the use of light of day.

## daylight

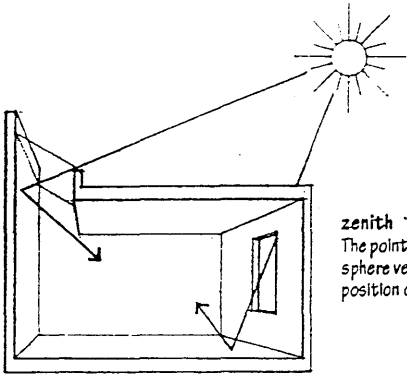
To provide an interior space with daylight from both direct and indirect sources.

## sunlight

The direct light of the sun.

## skylight

The light from the sky, reflected and diffused by air molecules.

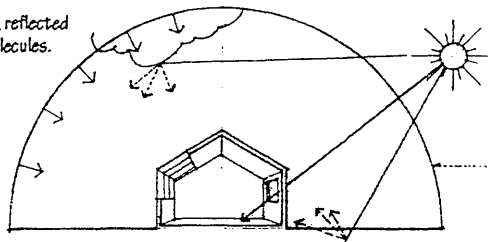
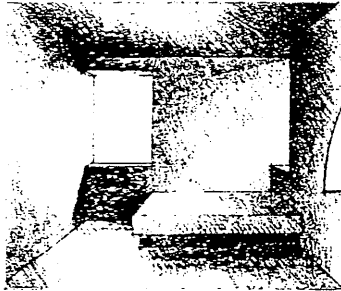


## counterlight

Light originating from sources facing each other, as from windows in opposite walls.

## crosslight

Light originating from sources not facing each other, as from windows in adjacent walls.

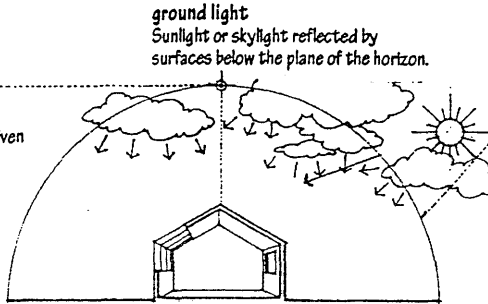


## clear sky

A sky having less than 30% cloud cover with the solar disk unobstructed. Also, the CIE standard for a reference cloudless sky condition, having the greatest luminance near the sun and least luminance 90° from the sun.

## zenith

The point on the celestial sphere vertically above a given position or observer.

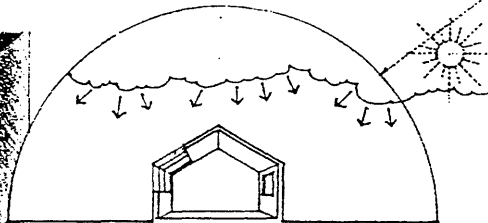


## ground light

Sunlight or skylight reflected by surfaces below the plane of the horizon.

## cloudy sky

A sky having between 30% and 70% cloud cover, with the solar disk obstructed.



## overcast sky

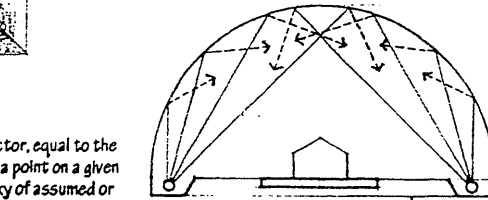
A sky having 100% cloud cover. Also, the CIE standard for a reference sky having a luminance distribution three times brighter near the zenith than at the horizon.

## CIE

Commission Internationale de l'Éclairage, an international commission developing definitions, standards, and procedures for the art, science, and technology of lighting.

## IES

Illuminating Engineering Society, a professional society in North America devoted to the development and dissemination of standards and procedures relating to the art, science, and technology of lighting.



## artificial sky

A hemispherical dome or similar enclosure illuminated by concealed light sources that simulate the luminance distribution of a clear or overcast sky, used for studying and testing daylighting techniques on architectural models placed near its center.

## daylight factor method

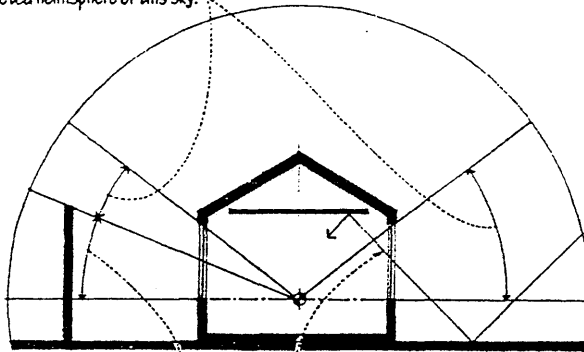
A method for calculating the performance of a daylighting system, based on the daylight factor.

## sky component

A component of the daylight factor, equal to the ratio of daylight illumination at a point on a given plane received directly from a sky of assumed or known luminance distribution to the simultaneously measured illuminance on a horizontal plane from an unobstructed hemisphere of this sky.

## daylight factor

A measure of daylight illuminance, expressed as the ratio of daylight illumination at a point on a given plane to the simultaneously measured illuminance on a horizontal plane from an unobstructed sky of assumed or known luminance distribution.

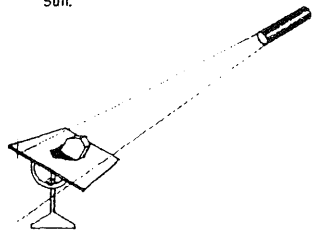


## external reflected component

A component of the daylight factor, equal to the ratio of the daylight illumination at a point on a given plane received directly from exterior reflecting surfaces to the simultaneously measured illuminance on a horizontal plane from an unobstructed sky of assumed or known luminance distribution.

## internal reflected component

A component of the daylight factor, equal to the ratio of the daylight illumination at a point on a given plane received directly or indirectly from interior reflecting surfaces to the simultaneously measured illuminance on a horizontal plane from an unobstructed sky of assumed or known luminance distribution.



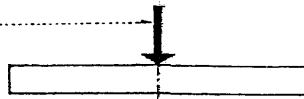
## heliodon

A device for orienting an architectural model to a light source representing the sun, calibrated with respect to latitude, time of day, and season of the year and used for studying daylighting techniques and shadows cast by the sun.

Any of the forces to which a structure is subjected.

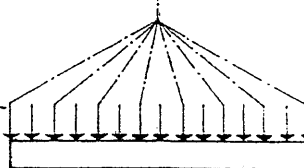
**concentrated load**

A load acting on a very small area or particular point of a supporting structural element.



**distributed load**

A load extending over the length or area of the supporting structural element.



**uniformly distributed load**

A distributed load of uniform magnitude.

**static load**

A load applied slowly to a structure until it reaches its peak value without fluctuating rapidly in magnitude or position. Under a static load, a structure responds slowly and its deformation reaches a peak when the static force is maximum.

**occupancy load**

The live load on a structure resulting from the weight of people, furniture, stored material, and other similar items in a building. Building codes specify minimum live loads for various uses and occupancies.

**snow load**

The live load resulting from the weight of snow accumulating on a roof. Snow loads vary with geographic location, site exposure, wind conditions, and roof geometry.

**water load**

The live load of water that may accumulate on a roof because of its form, deflection, or the clogging of its drainage system.

**live load**

Any moving or movable load on a structure resulting from occupancy, collected snow and water, or moving equipment. A live load typically acts vertically downward, but may act horizontally as well to reflect the dynamic nature of a moving load.

**dead load**

The static load acting vertically downward on a structure, comprising the self-weight of the structure and the weight of building elements, fixtures, and equipment permanently attached to it.

**water pressure**

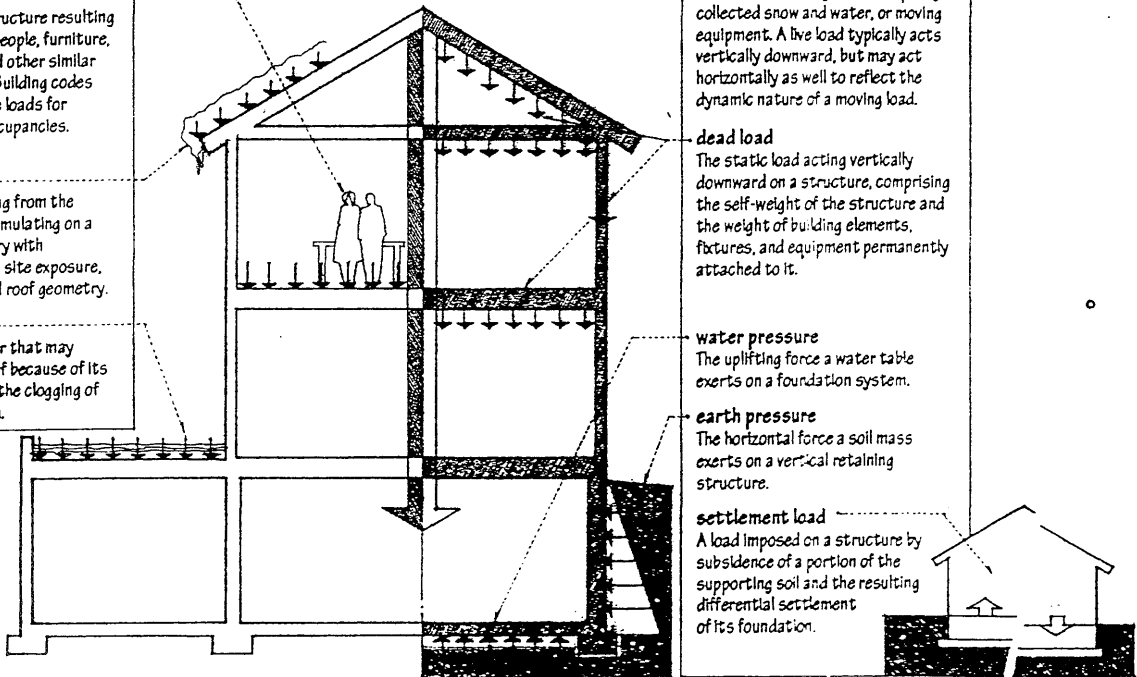
The uplifting force a water table exerts on a foundation system.

**earth pressure**

The horizontal force a soil mass exerts on a vertical retaining structure.

**settlement load**

A load imposed on a structure by subsidence of a portion of the supporting soil and the resulting differential settlement of its foundation.



**equivalent load**

A load substituted by a building code for an actual load, derived on the basis of statistical evidence for given types of buildings. For safety, the equivalent load is usually a multiple of the load that would produce failure or unacceptable deflection.

**load combination**

The dead load and two or more live loads assumed to occur simultaneously on a structure when their combined effect can be reasonably expected to be less than the sum of their separate actions.

1.00 (dead + live + snow loads)

0.75 (dead + live + snow + wind or seismic loads)

**load reduction**

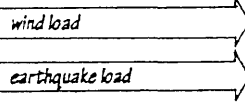
A reduction in design loading allowed by building codes for certain load combinations, based on the assumption that not all live loads will act simultaneously on a structure at their full value. After all possible load combinations are considered, a structure is designed to carry the most severe but realistic distribution, concentration, and combination of loads.

**erection stress**

The stress induced on a building unit or component by loads applied during the erection process.

**erection bracing**

The temporary bracing required to secure the units or components of a building until permanently fastened in place.



**moving load**

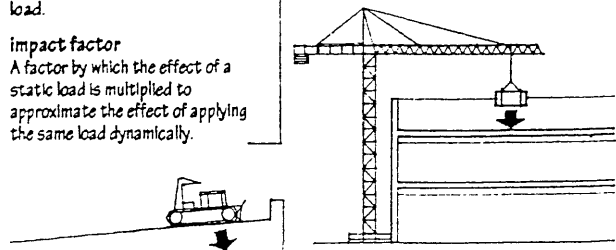
A kinetic load of short duration due to moving vehicles, equipment, and machinery. Building codes treat this load as a static load, compensating for its dynamic nature by amplifying the static load. Also called impact load.

**impact factor**

A factor by which the effect of a static load is multiplied to approximate the effect of applying the same load dynamically.

**dynamic load**

A load applied suddenly to a structure, often with rapid changes in magnitude and location. Under a dynamic load, a structure develops inertial forces in relation to its mass and its maximum deformation does not necessarily correspond to the maximum magnitude of the applied force.



**construction load**

A temporary load on a structure occurring during its erection, as from wind or the weight of construction equipment and stored materials.

# LOAD

## lateral load

A load acting horizontally on a structure, as a wind or earthquake load.

## earthquake load

The forces exerted on a structure by an earthquake.

## earthquake

A series of longitudinal and transverse vibrations induced in the earth's crust by the abrupt movement of plates along fault lines. The shocks of an earthquake propagate along the earth's surface in the form of waves and attenuate logarithmically with distance from its source.

## epicenter

A point directly above the hypocenter, from which the shock waves of an earthquake apparently emanate.

## hypocenter

The point of origin of an earthquake. Also called focus.

## fault

A break in the earth's crust accompanied by a dislocation in the plane of the fracture.

## plate

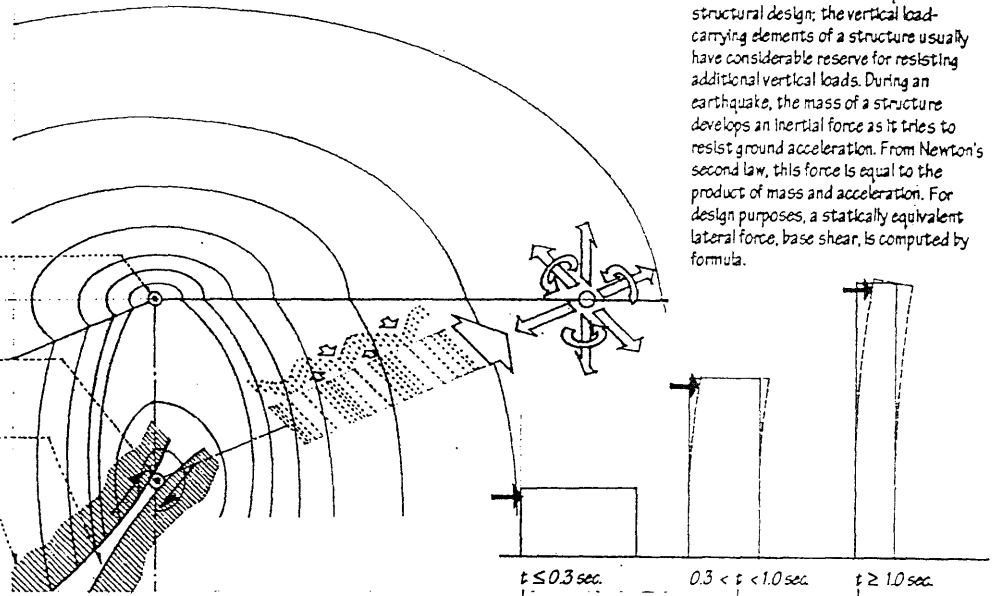
Any of the huge movable segments into which the earth's crust is divided.

## seismic

Of, pertaining to, or caused by an earthquake or vibration of the earth.

## seismic force

Any of the forces caused by the vibratory ground motions of an earthquake. While these motions are three-dimensional in nature, their horizontal components are considered to be the most important in structural design; the vertical load-carrying elements of a structure usually have considerable reserve for resisting additional vertical loads. During an earthquake, the mass of a structure develops an inertial force as it tries to resist ground acceleration. From Newton's second law, this force is equal to the product of mass and acceleration. For design purposes, a statically equivalent lateral force, base shear, is computed by formula.



## vibration

The oscillating, reciprocating, or other periodic motion of an elastic body or medium when forced from a position or state of equilibrium.

## periodic motion

Any motion that recurs in the same form at equal intervals of time.

## harmonic motion

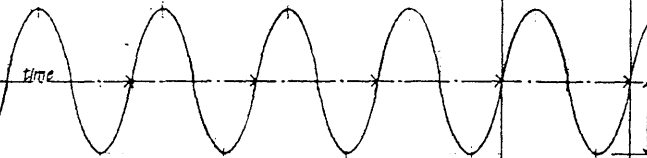
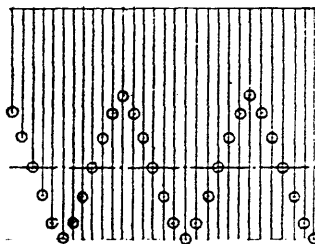
Periodic motion consisting of one or more vibratory motions that are symmetric about a region of equilibrium, as the motion of a vibrating string of a musical instrument.

## period

The time required for one complete cycle of a wave or oscillation.

## natural period of vibration

The time required for a body subject to a vibratory force to go through one oscillation in the direction under consideration. A structure's natural period of vibration varies according to its height above the base and its dimension parallel to the direction of the applied forces. A relatively stiff structure tends to oscillate rapidly and has a short period of vibration while a more flexible structure tends to oscillate slowly and has a longer period. Also called fundamental period of vibration.



## amplitude

The maximum displacement from the mean position during one period of an oscillation.

## oscillation

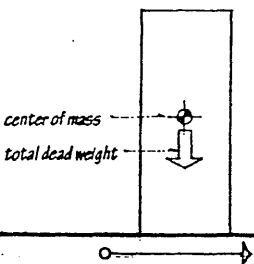
A single swing of an oscillating body from one extreme limit to another.

## oscillate

To swing back and forth like a pendulum between alternating extremes.

## resonance

An abnormally large vibration in a system caused by a relatively small vibratory force of the same or nearly the same period as the natural period of vibration of the system.



## drift

The lateral deflection or movement of a structure due to wind, earthquake, or asymmetrical vertical loading.

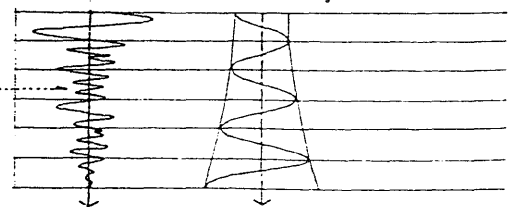
inertial force resisting ground acceleration

## ground acceleration

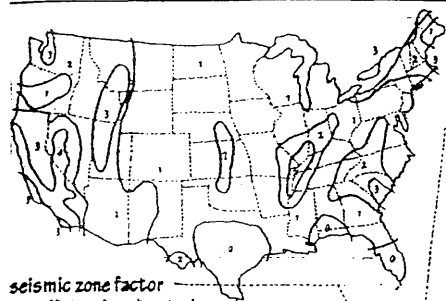
The rate of change in the velocity of ground movement with respect to time. High accelerations are the most damaging to a structure, which must try to follow the rapid changes in ground movement during an earthquake.

## damping

The absorption or dissipation of energy to progressively diminish successive oscillations or waves of a vibrating structure.





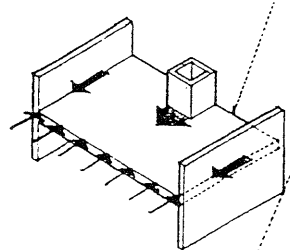


**seismic zone factor**  
A coefficient for adjusting base shear according to the probable seismic activity and intensity of a geographic location. There are 5 seismic zones in the U.S., with zone 0 being the least active and zone 4 being an area close to a major fault system.

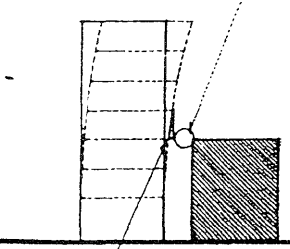
**seismic coefficient**  
A coefficient for adjusting base shear according to the relationship between the natural period of vibration of a structure and that of the underlying soil on which the structure rests. When these periods are similar, base shear is increased to reflect the likelihood of destructive resonances occurring in the structure. Also called base shear coefficient.

**site coefficient**  
A coefficient reflecting the nature and profile of the foundation soil, usually based on a geotechnical investigation. Ground movements are potentially much greater in alluvial soils than in rocky areas or diluvial soils.

**liquefaction**  
The sudden loss of shearing resistance in a cohesionless soil, causing the soil mass to behave as a liquid.



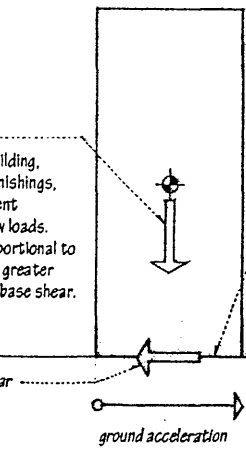
**building separation**  
The distance required to avoid contact between separated structures under deflection from seismic action or wind forces.



**story drift**  
The horizontal movement of one level of a structure relative to the level above or below.

**drift index**  
The maximum ratio of story drift to story height, allowed by a building code in order to minimize damage to building components or adjacent structures. Also called drift limitation.

**horizontal torsion**  
The torsion resulting from a lateral load acting on a structure having noncolocident centers of mass and resistance. To avoid destructive torsional effects, structures subject to lateral loads should be arranged and braced symmetrically with centers of mass and resistance as colocident as possible. In asymmetrical layouts, bracing elements should be distributed with stiffnesses that correspond to the distribution of the mass.



**importance factor**

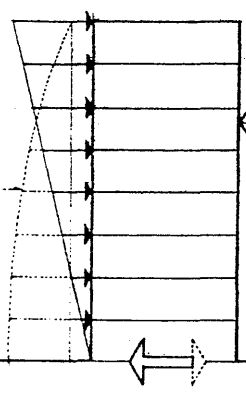
**weight factor**  
The total dead load of a building, including the weight of furnishings, stored materials, permanent equipment, and heavy snow loads. Base shear is directly proportional to the mass of a building; the greater the mass, the greater the base shear.

$$\frac{CZI}{R_w} W = V$$

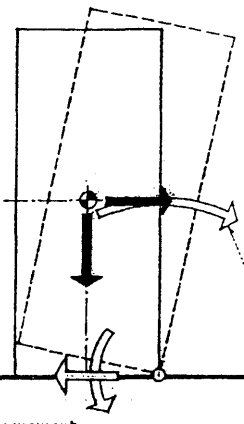
base shear

**base**  
The level at which earthquake motions are assumed to be imparted to a structure.

**base shear**  
The shearing force developed at the base of a structure by the tendency of its upper mass to remain at rest while the base is translated by ground motions during an earthquake. Base shear is the minimum design value for the total lateral seismic force on a structure, and is assumed to act nonconcurrently in the direction of each of the main axes of the structure. It is computed by multiplying the total dead load of the structure by a number of coefficients to reflect the character and intensity of the ground motions, the mass and stiffness of the structure and the way these are distributed, the type of soil underlying the foundation, and the presence of damping mechanisms in the structure.



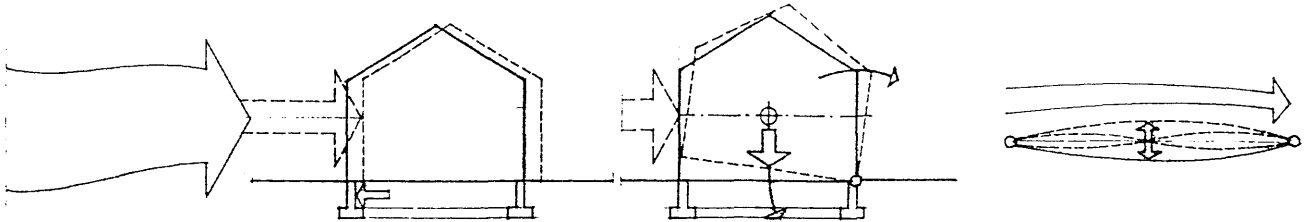
**distribution of base shear**  
The manner in which base shear is distributed over the height of a structure according to the displacements that would occur during an earthquake. For a building of regular rectangular shape with equal floor weights and heights and no irregularities in stiffness or mass, base shear is distributed to each horizontal diaphragm above the base in proportion to the floor weight at each level and its distance from the base. This results in a triangular load configuration varying from zero at the base to a maximum value at the top. For structures having a natural period of vibration greater than 0.7 seconds, a portion of the total base shear is assumed to be concentrated at the top of the structure to account for the whiplash effect of seismic forces. For structures with irregular shapes or framing systems, the distribution of lateral forces should be determined according to the relative stiffnesses of adjacent floor levels and the dynamic characteristics of the structure.



**overturning moment**  
An external moment generated at the base of a structure by a lateral load applied at a distance above grade. For equilibrium, the overturning moment must be counterbalanced by an external restoring moment and an internal resisting moment provided by forces developed in column members and shear walls.

**restoring moment**  
A resisting moment provided by the dead load of a structure acting about the same point of rotation as the overturning movement. Building codes usually require that the restoring moment be at least 50% greater than the overturning moment. Also called righting moment, stabilizing moment.

# LOAD



## wind load

Any of the forces exerted by the kinetic energy of a moving mass of air, resulting in pressure on certain parts of a structure and suction on others.

## sliding

The horizontal movement of a structure in response to a lateral load.

## uplift

The raising of a structure or portion of structure in response to an overturning moment or wind suction.

## flutter

The rapid oscillations of a flexible cable or membrane structure caused by the aerodynamic effects of wind. Also called aerodynamic oscillation.

## Bernoulli equation

An expression of the conservation of energy in streamline flow, stating that the sum of the ratio of pressure to mass density, the square of the velocity divided by 2, and the product of the gravitational constant and vertical height, remains constant. Also called Bernoulli's theorem.

## dynamic wind pressure

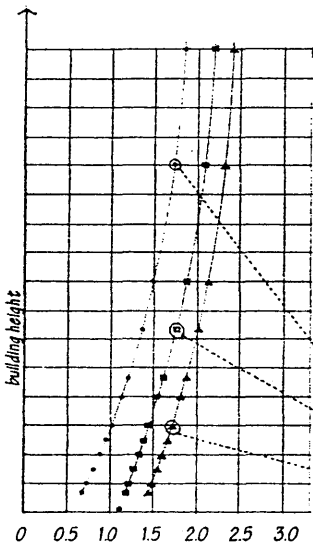
The pressure exerted by a moving mass of air, derived from Bernoulli's equation and equal to the product of the mass density of the air and the square of the velocity at a given height divided by 2.

## design wind pressure

A minimum design value for the equivalent static pressure on the exterior surfaces of a structure resulting from a critical wind velocity, equal to the wind stagnation pressure modified by a number of coefficients to account for the effects of exposure condition, building height, wind gusts, and the geometry and orientation of the structure to the impinging air flow.

## importance factor

A coefficient for increasing the design values for wind or seismic forces on a building because of its large occupancy, its potentially hazardous contents, or its essential nature in the wake of a hurricane or earthquake.



## height factor

A coefficient increasing design wind pressure to account for the increase in wind velocity with height above the ground.

## gust factor

A coefficient increasing design wind pressure to account for the dynamic effects of wind gusts.

## exposure condition

One of four conditions modifying design wind pressure according to obstructions in the area surrounding a building site.

exposure A: urban areas with high-rise buildings, or rough, hilly terrain;

exposure B: suburban sites, wooded areas, or rolling terrain;

exposure C: flat, open terrain with minimal obstructions;

exposure D: flat, unobstructed terrain facing large bodies of water.

The more open a site, the greater the wind speed and the resulting design wind pressure.

$$P = C_e C_q q_s I$$

## pressure coefficient

A coefficient modifying design wind pressure to reflect how the geometry and orientation of the various parts of a structure alter the effects of an impinging air flow. Inward or positive coefficients result in wind pressure while outward or negative coefficients result in wind suction.

## wind stagnation pressure

The static equivalent to dynamic wind pressure used as a reference in calculating design wind pressure, specified in pounds per square foot and equal to 0.00256 times the square of the basic wind speed for the geographic location. Wind velocity approaches zero as the moving air mass parts to flow around an obstruction. Since the sum of static and dynamic pressures remains constant in streamline flow, all of the energy in the flow at this point of stagnation is in the form of static pressure.

## basic wind speed

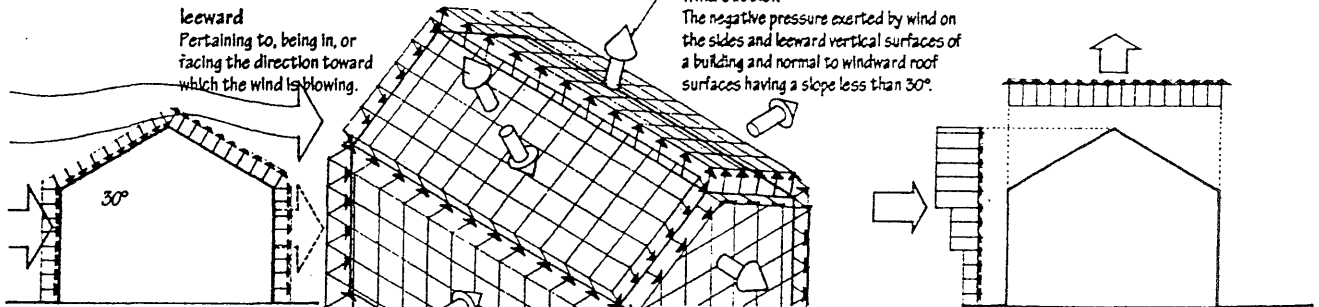
The wind velocity used in calculating wind stagnation pressure, usually the extreme fastest-mile wind speed recorded for a geographic location at a standard height of 33 ft. (10 m) and based on a 50-year mean occurrence interval. Also called design wind velocity.

## fastest-mile wind speed

The average speed of a one-mile-long column of air that passes over a given point, measured in miles per hour.

## leeward

Pertaining to, being in, or facing the direction toward which the wind is blowing.



## windward

Pertaining to, being in, or facing the direction from which the wind blows.

## wind pressure

The pressure exerted by wind horizontally on the windward vertical surfaces of a building and normal to windward roof surfaces having a slope greater than 30°.

## wind suction

The negative pressure exerted by wind on the sides and leeward vertical surfaces of a building and normal to windward roof surfaces having a slope less than 30°.

## normal force method

A design method for applying design wind pressure to the primary frame and bracing systems of a building, in which wind pressures are assumed to act simultaneously normal to all exterior surfaces. This method may be used for any structure, but is required for gabled rigid frames.

Tall, slender buildings, structures with unusual or complex shapes, and lightweight, flexible structures subject to flutter require wind tunnel testing or computer modeling to investigate how they respond to the distribution of wind pressure.

## projected area method

A design method for applying design wind pressure to the primary frame and bracing systems of a building. In which the total wind effect is considered to be a combination of a single inward or positive horizontal pressure acting on the full vertical projected area of the building and an outward or negative pressure acting on the full horizontal projected area of the building. This method may be used for any structure less than 200 ft. (61 m) high, except for gabled rigid frames.

Building with units of various natural or manufactured products, as stone, brick, or concrete block, usually with the use of mortar as a bonding agent.

**field**  
The expanse of a masonry wall between openings and corners, usually composed primarily of stretchers.

**head joint**  
The vertical joint between two masonry units, perpendicular to the face of a wall.

**shoved joint**  
A head joint formed by applying mortar to the end of a masonry unit and forcing it in position against the last masonry unit laid.

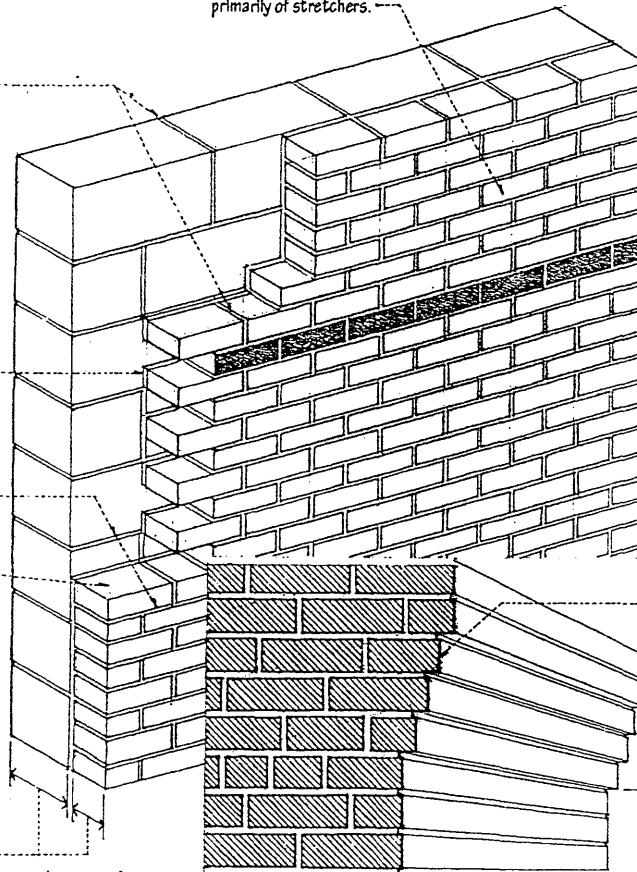
**collar joint**  
The vertical joint between two wythes of masonry.

**bed joint**  
The horizontal joint between two masonry courses.

**bed**  
The underside of a brick or other masonry unit, or the layer of mortar in which a masonry unit is laid.

**clip joint**  
A bed joint made thicker than usual in order to level the course above.

**wythe**  
A continuous vertical section of a masonry wall one unit in thickness. Also, wythe.



**course**  
A continuous, usually horizontal range of bricks, tiles, or shingles, as in a wall or roof.

**range**  
A continuous course of masonry units having the same height from end to end.

**closer**  
The last masonry unit laid in a course.

**corbel**  
A brick or stone projecting from within a wall, usually to support a weight.

**corbeling**  
An overlapping arrangement of bricks or stones in which each course steps upward and outward from the vertical face of a wall.

**tooled joint**  
A weather-resistant mortar joint compressed and shaped with any tool other than a trowel.

**troweled joint**  
A mortar joint finished by striking off excess mortar with a trowel.

**concave joint**  
A curved, hollowed mortar joint formed by a rounded bar.

**V-joint**  
An angular, hollowed mortar joint formed by a V-shaped jointer.

**weathered joint**  
A mortar joint smoothed by pressing the trowel in at the upper edge of the joint, forming a sloping surface that sheds water readily.

**flush joint**  
A mortar joint struck flush with the masonry.

**struck joint**  
A mortar joint pressed in at the lower edge and sloping in the reverse direction from a weathered joint.

**raked joint**  
A mortar joint made by removing mortar to a given depth with a square-edged tool before hardening.

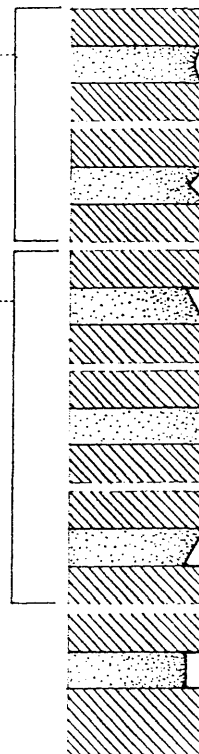
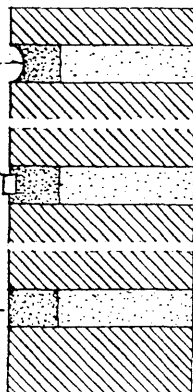
**point**  
To fill and finish the surface of a masonry joint with mortar after the masonry has been laid, either to finish the joint or to repair a defective joint.

**tuck pointing**  
The process of raking out defective mortar from a masonry joint, filling with fresh mortar, and tooling the joint.

**tuck and pat pointing**  
Tuck pointing having an ornamental fillet of lime or putty projecting from the joint.

**bastard pointing**  
An imitation of tuck and pat pointing, having a fillet made from the mortar of the joint.

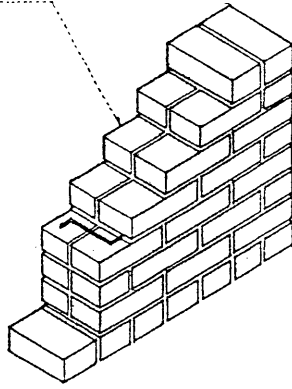
**flat-joint pointing**  
Pointing having flush joints of common mortar.



# MASONRY

## solid masonry

A wall constructed of brick or other solid masonry units laid contiguously with all joints solidly filled with mortar and adjacent wythes bonded by masonry headers or metal ties.



## cavity wall

A masonry wall having a facing and backing completely separated except for metal ties and enclosing an inner space serving to prevent penetration by water.

### facing

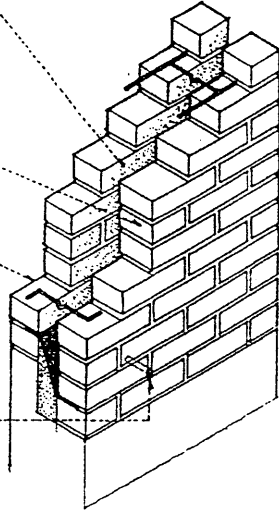
An ornamental or protective layer, as the outer wythe of a masonry wall.

### backing

Something that forms the back or provides support, strength, or protection from the back, as the inner wythe or wythes of a masonry wall.

### weep hole

A small opening in a cavity wall, retaining wall, or other construction for draining off accumulated moisture, as from condensation or leakage.



## faced wall

A wall having a masonry facing bonded to a backing so as to exert a common action under load.

### adhered veneer

A veneer supported by and secured to a backing by means of a bonding material.

### veneer

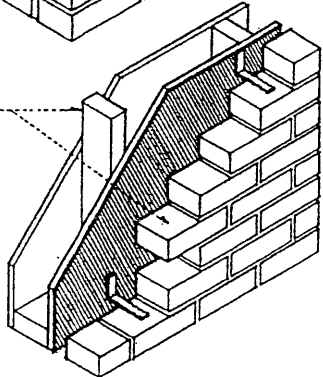
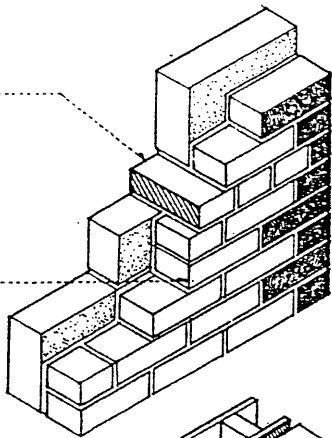
A nonstructural facing of brick, stone, concrete, or tile attached to a backing for the purpose of ornamentation, protection, or insulation.

### veneered wall

A wall having a nonstructural facing attached but not bonded to a supporting structure.

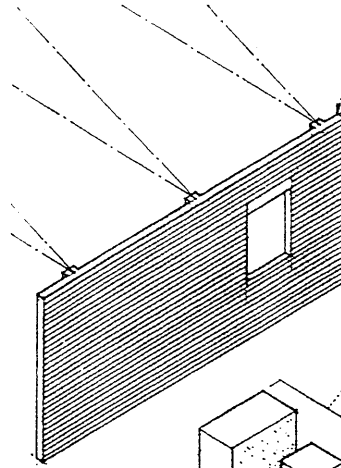
### anchored veneer

A veneer supported by and secured to a backing by means of mechanical fasteners.



## economy wall

A brick wall 4 in. (102 mm) thick, plastered and strengthened at intervals with 8-in. (203-mm) pilasters to support roof trusses.



## composite wall

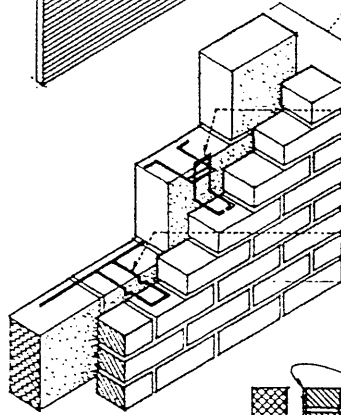
A masonry wall having at least one wythe dissimilar to the other wythe or wythes with respect to type or grade of masonry unit or mortar.

### adjustable tie

A metal tie consisting of two interlocking parts which enable it to adapt to bed joints at different elevations.

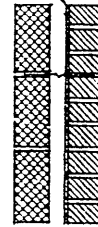
### tie

Any of various corrosion-resistant metal devices for holding two parts of a construction together, as the wythes of a masonry wall.



### back plaster

To parge a part of a wall that is not seen, as behind the outer wythe of a cavity wall in order to exclude air and moisture from the interior of the wall.

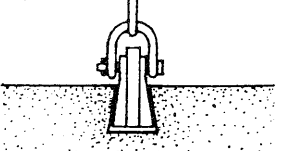


## panel wall

A non-load-bearing exterior masonry wall wholly supported at each story.

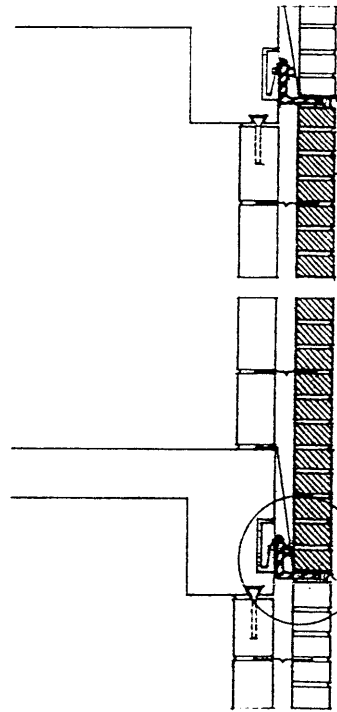
### lewis

A device for lifting a dressed stone or precast concrete panel, consisting of a number of pieces fitting together to fill a dovetailed recess cut into the stone or panel.



### soft joint

A compressible joint directly below a supporting shelf or relieving angle, allowing for the expansion and contraction of a panel wall and preventing the weight of higher courses from being transmitted to the masonry below.



**mortar**  
A plastic mixture of lime or cement, or a combination of both, with sand and water, used as a bonding agent in masonry construction.

**cement mortar**  
A mortar made by mixing portland cement, sand, and water.

**cement-lime mortar**  
A cement mortar to which lime is added to increase its plasticity and water-retentivity.

**masonry cement**  
A proprietary mix of portland cement and other ingredients, as hydrated lime, plasticizers, air-entraining agents, and gypsum, requiring only the addition of sand and water to make cement mortar.

**epoxy mortar**  
A mortar consisting of epoxy resin, a catalyst, and fine aggregate.

**nonstaining mortar**  
A mortar having a low free-alkali content to minimize efflorescence or the staining of adjacent masonry by the migration of soluble materials.

**lime mortar**  
A mixture of lime, sand, and water that is rarely used because of its slow rate of hardening and low compressive strength.

**lime**  
A white or grayish white, caustic, odorless solid obtained by heating forms of calcium carbonate, as shells or limestone, at a high temperature. Also called calcium oxide, calx, caustic lime, quicklime.

**hydrated lime**  
A soft, crystalline powder obtained by the action of water on lime and used in making mortar, plaster, and cement. Also called calcium hydroxide, slaked lime.

**green**  
Of or pertaining to concrete or mortar that is freshly set but not completely hardened.

**fat mix**  
A concrete or mortar mix that is easy to work or spread because of a relatively high cement or lime content. Also called rich mix.

**lean mix**  
A concrete or mortar mix that is difficult to work or spread because of a shortness of cement or lime.

**plasticizer**  
An admixture for making a concrete or mortar mix workable with little water.

**Type M mortar**  
A high-strength mortar recommended for use in reinforced masonry below grade or in contact with the earth, as foundation and retaining walls subject to frost action or to high lateral or compressive loads.

**Type S mortar**  
A medium-high-strength mortar recommended for use in masonry where bond and lateral strength are more important than compressive strength.

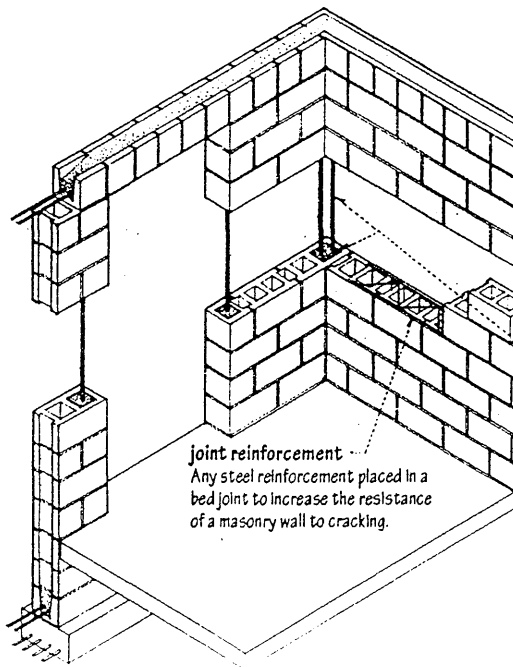
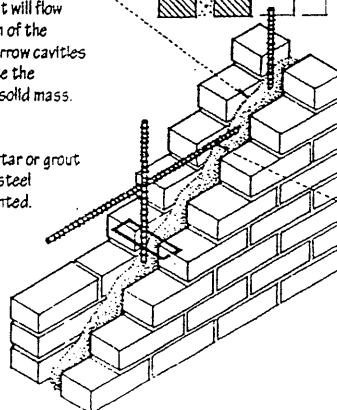
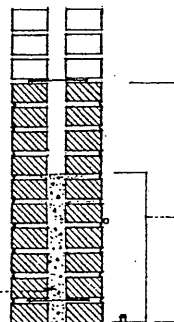
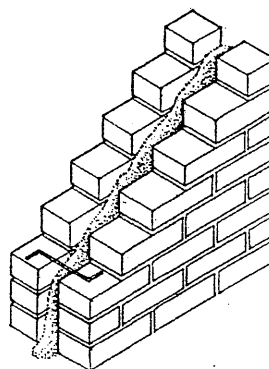
**Type N mortar**  
A medium-strength mortar recommended for general use in exposed masonry above grade where high compressive and lateral strength are not required.

**Type O mortar**  
A low-strength mortar suitable for use in interior non-load-bearing walls and partitions.

**Type K mortar**  
A very-low-strength mortar suitable only for use in interior non-load-bearing walls where permitted by the building code.

**grout**  
A fluid cement mortar that will flow easily without segregation of the ingredients, used to fill narrow cavities in masonry and consolidate the adjoining materials into a solid mass.

**bond**  
The adhesion between mortar or grout and the masonry units or steel reinforcement being cemented.



**grouted masonry**  
A wall constructed of brick or concrete brick units with all interior joints being filled with grout as the work progresses.

**high-lift grouting**  
A technique for grouting a masonry wall constructed a story at a time in lifts not exceeding 6 feet (1.8 m).

**low-lift grouting**  
A technique for grouting a masonry wall in lifts not exceeding six times the width of the grout space or a maximum of 8 inches (203 mm) as the wall is built.

**grout pour**  
The total height of masonry to be filled with grout before the erection of additional masonry, consisting of one or more grout lifts.

**grout lift**  
An increment of grout height within a total grout pour.

**cleanout**  
Any of a series of temporary openings at the bottom of a masonry wall large enough to permit the removal of debris or obstructions from a cavity or cell prior to grouting.

**reinforced grouted masonry**  
A masonry wall constructed with horizontal and vertical steel reinforcement fully embedded in grout for increased resistance to buckling and lateral wind and seismic loads.

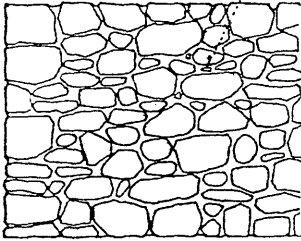
**hollow unit masonry**  
A wall constructed of hollow masonry units laid and set with mortar, with adjacent wythes bonded by masonry headers or metal ties.

**reinforced hollow-unit masonry**  
Hollow unit masonry having certain cells continuously filled with concrete or grout, in which reinforcing steel is embedded for increased resistance to buckling and lateral wind and seismic loads.

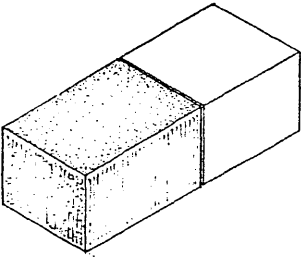
**joint reinforcement**  
Any steel reinforcement placed in a bed joint to increase the resistance of a masonry wall to cracking.

# MASONRY

**rubble**  
Rough fragments of broken stone or the masonry built of such stones.

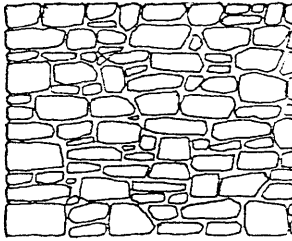


**random rubble**  
A rubble wall having discontinuous but approximately level beds or courses.

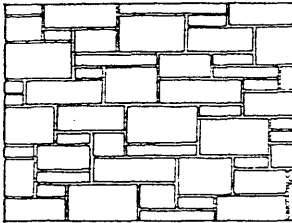


**ashlar**  
A squared building stone finely dressed on all faces adjacent to those of other stones so as to permit very thin mortar joints.

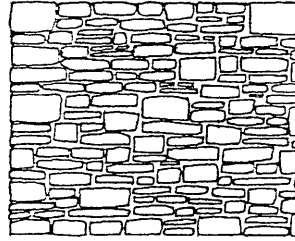
**gallet**  
To embed small stone chips in the mortar joints of rough masonry to wedge larger stones in position or add detail to the appearance. Also, garret.



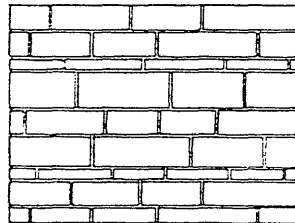
**coursed rubble**  
A rubble wall having approximately level beds and brought at intervals to continuous level courses.



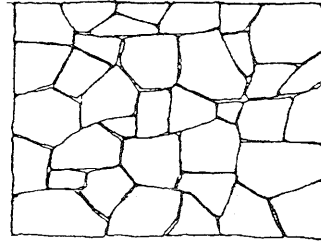
**random ashlar**  
Ashlar masonry built in discontinuous courses.



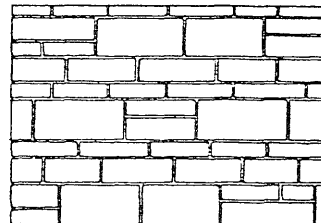
**squared rubble**  
A rubble wall built of squared stones of varying sizes and coursed at every third or fourth stone.



**coursed ashlar**  
Ashlar masonry built of stones having the same height within each course, but each course varying in height.

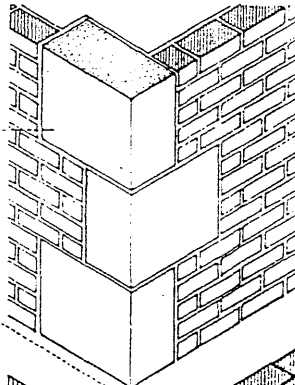


**cyclopean**  
Formed with large, irregular blocks of stones fitted closely together without the use of mortar.



**broken rangework**  
Ashlar masonry laid in horizontal courses of varying heights, any one of which may be broken at intervals into two or more courses.

**quoin**  
An exterior angle of a masonry wall, or one of the stones or bricks forming such an angle, usually differentiated from adjoining surfaces by material, texture, color, size, or projection.

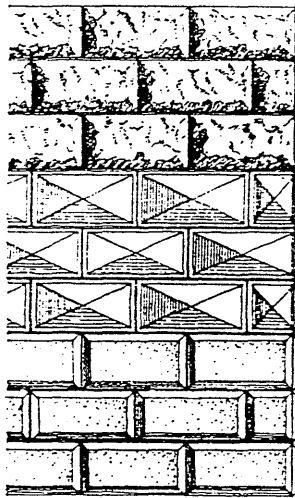
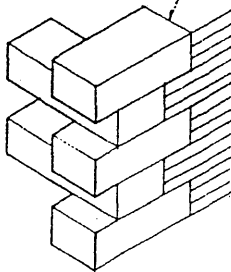


**perpend**  
A large stone passing through the entire thickness of a wall and exposed on both faces. Also called through stone.

**bondstone**  
A stone for bonding facing masonry to a masonry backing. Also called binder.

**long-and-short work**  
An arrangement of rectangular quoins or jambstones set alternately horizontally and vertically.

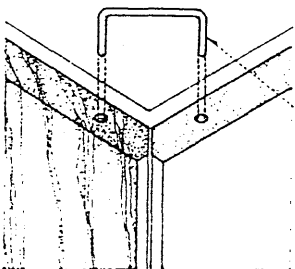
**in-and-out bond**  
A masonry bond having headers and stretchers alternating vertically.



**rustication**  
Ashlar masonry having the visible faces of the dressed stones raised or otherwise contrasted with the horizontal and usually the vertical joints, which may be rabbeted, chamfered, or beveled.

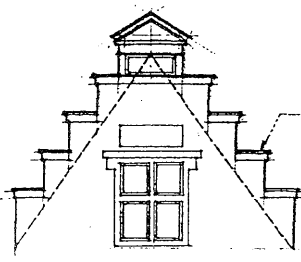
**rustic joint**  
A mortar joint between stones recessed from the adjacent faces between sunken drafts or bevells.

**rustic**  
Having rough, irregular surfaces and sunken or beveled joints.



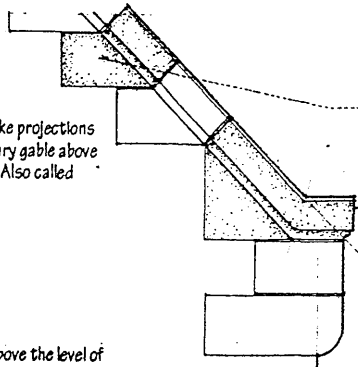
**interlocking joint**  
A joint in ashlar masonry made by fitting a projection on one stone into a routed groove on the next stone.

**cramp iron**  
An iron bar or rod with bent ends for holding together stone masonry units.



**corbie gable**  
A gable having corblesteps.

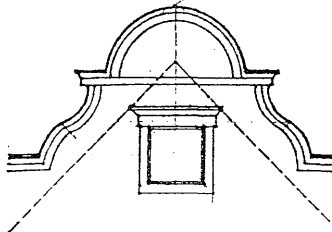
**corblestep**  
Any of a series of steplike projections that terminate a masonry gable above the surface of the roof. Also called crowstep.



**capstone**  
A finishing stone of a structure, as a copestone.

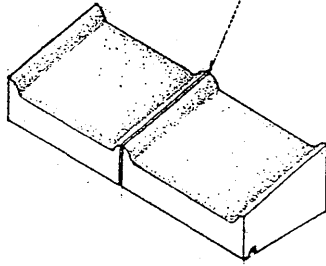
**kneeler**  
Any of the stones having a sloping top for supporting or forming a gable coping. Also called skew.

**skew corbel**  
A stone overhanging at the foot of a gable coping, often serving as a stop for eave gutters or wall cornices.



**fractable**  
A coping on a gable wall concealing the slopes of the roof, esp. one having an ornamental silhouette.

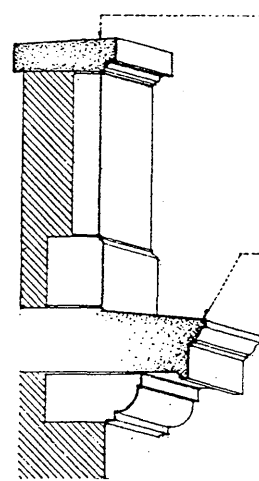
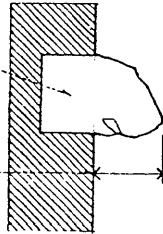
**saddle joint**  
A vertical joint raised above the level of the washes on a stone sill or coping to prevent the penetration of rainwater.



**boss**  
A stone roughly formed and set in place for later carving.

**tail in**  
To fasten a beam or stone by one end.

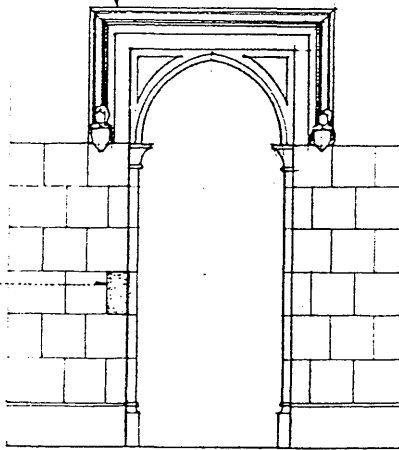
**tailing**  
The part of a stone or brick projecting from a wall.



**copestone**  
A stone forming a coping.

**dripstone**  
A stone molding used as a drip, as on a cornice over a window or doorway.

**label**  
A molding or dripstone over a door or window, esp. one that extends horizontally across the top of the opening and vertically downward for a short distance at the sides.



**jambstone**  
A stone, or one of the stones, forming the jamb of a door or window opening.

**string course**  
A horizontal course of brick or stone flush with or projecting beyond the face of a building, often molded to mark a division in the wall. Also called belt course.

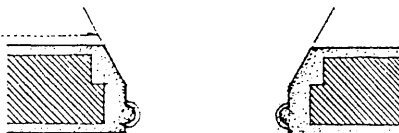
**cordons**  
A stringcourse, esp. one having little or no projection.

**table**  
A course or band, esp. of masonry, having a distinctive form or position.

**water table**  
A projecting stringcourse, molding, or ledge placed so as to divert rainwater from a building.

**scarcement**  
A footing or ledge formed by a setback in the face of a wall.

**embrasure**  
A splayed enlargement of a door or window opening toward the inner face of a wall.



**plinth**  
A continuous, usually projecting course of stones forming the base or foundation of a wall. Also called plinth course.

# MASONRY

## concrete masonry unit

A precast masonry unit of portland cement, fine aggregate, and water, molded into various shapes.

## stretcher block

A concrete masonry unit having nominal dimensions of 8 x 8 x 16 in. (203 x 203 x 406 mm).

## partition block

A concrete masonry unit used in constructing non-load-bearing walls, usually having a nominal thickness of 4 or 6 in. (102 or 152 mm).

## bullnose block

A concrete masonry unit having one or more rounded exterior corners.

## corner block

A concrete masonry unit having a solid end face and used in constructing the end or corner of a wall.

## return-corner block

A concrete masonry unit used at the corners of walls to maintain horizontal coursing with the appearance of full- and half-length units.

## double-corner block

A concrete masonry unit having solid faces at both ends and used in constructing a masonry pier.

## pilaster block

Any of various concrete masonry units used in constructing a plain or reinforced masonry pilaster.

## coping block

A solid concrete masonry unit used in constructing the top or finishing course of a masonry wall.

## sash block

A concrete masonry unit having an end slot or rabbet to receive the jamb of a door or window frame. Also called jamb block.

## sill block

A solid concrete masonry unit having a wash to shed rainwater from a sill.

## wash

An upper surface inclined to shed rain water from a building. Also called weathering.

## cap block

A concrete masonry unit having a solid top for use as a bearing surface in the finishing course of a foundation wall. Also called solid-top block.

## control-joint block

Any of various concrete masonry units used in constructing a vertical control joint.

## bond-beam block

A concrete masonry unit used in constructing a bond beam, having a depressed section in which reinforcing steel can be placed for embedment in grout.

## bond beam

A masonry course grouted and reinforced to serve as a beam, a horizontal tie, or a bearing course for structural members.

## concrete block

A hollow or solid concrete masonry unit, often incorrectly referred to as cement block.

## face shell

One of the two sidewalls of a hollow concrete masonry unit.

## web

One of the cross walls connecting the face shells of a hollow masonry unit.

## core

The molded open space in a concrete masonry unit. Also called cell.

## open-end block

A concrete masonry unit having one end open in which vertical steel reinforcement can be placed for embedment in grout.

## lintel block

A concrete masonry unit used in constructing a lintel or bond beam, having a U-shaped section in which reinforcing steel can be placed for embedment in grout.

## header block

A concrete masonry unit having a portion of one face shell removed to receive headers in a bonded masonry wall.

## sound-absorbing masonry unit

A concrete masonry unit having a solid top and a slotted face shell, and sometimes a fibrous filler, for increased sound absorption.

## slump block

A concrete masonry unit having an irregular face and surface texture caused by the settlement of a wet mix during curing.

## split-face block

A concrete masonry unit, split lengthwise by a machine after curing to produce a rough, fractured face texture.

## faced block

A concrete masonry unit having a special ceramic, glazed, or polished face.

## scored block

Any of various concrete masonry units having one or more vertical grooves which simulate raked joints.

## shadow block

Any of various concrete masonry units having a face shell with a pattern of beveled recesses.

## screen block

A concrete masonry unit used esp. in tropical architecture, having a decorative pattern of transverse openings for admitting air and excluding sunlight.

## concrete brick

A solid rectangular concrete masonry unit, usually not larger than 4 x 4 x 12 in. (102 x 102 x 305 mm).

## sand-lime brick

A hard, light-colored brick made by molding a mixture of damp sand and slaked lime under high pressure and curing in a steam oven.

## solid masonry unit

A masonry unit having a net cross-sectional area in any plane parallel to the bearing surface that is 75% or more of the gross cross-sectional area measured in the same plane.

## hollow masonry unit

A masonry unit having a net cross-sectional area in any plane parallel to the bearing surface less than 75% of the gross cross-sectional area measured in the same plane.

## gross cross-sectional area

The total cross-sectional area of a hollow masonry unit perpendicular to the direction of loading, including cellular and reentrant spaces, except when these spaces are to be occupied by portions of adjacent masonry.

## net cross-sectional area

The gross cross-sectional area of a hollow masonry unit minus the area of ungrouted cores of cellular spaces.

## equivalent thickness

The thickness that would be obtained if the amount of concrete contained in a hollow masonry unit were recast without any cellular spaces, used esp. to determine the fire resistance of a wall constructed with such units.

## absorption

The weight of water absorbed by a concrete masonry unit when immersed in water, expressed in pounds of water per cubic foot of concrete.

## Grade N

A grade of load-bearing concrete masonry unit suitable for general use, as in exterior walls above and below grade.

## Grade S

A grade of load-bearing concrete masonry unit limited to use above grade, in exterior walls with weather-protective coatings, or in walls not exposed to the weather.

## Type I

A concrete masonry unit manufactured to a specified limit of moisture content in order to minimize the drying shrinkage that can cause cracking.

## Type II

A concrete masonry unit not manufactured to a specified limit moisture content.

## normal-weight block

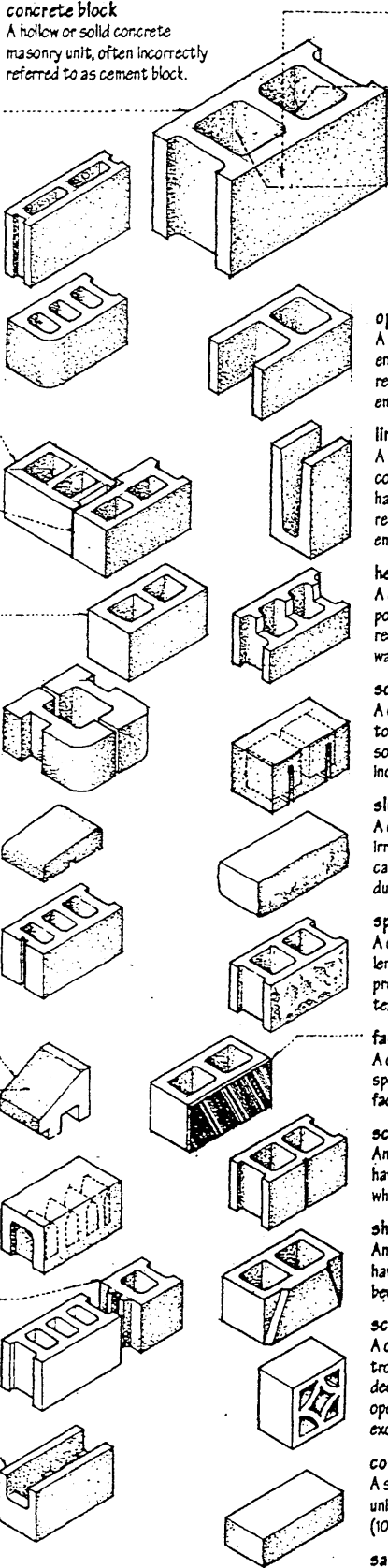
A concrete masonry unit made with sand, gravel, or other dense aggregate and weighing more than 125 pcf (2000 kg/m<sup>3</sup>).

## lightweight block

A concrete masonry unit made with lightweight aggregate, as cinder or expanded slag, and weighing less than 125 pcf (2000 kg/m<sup>3</sup>).

## surface bonding

The bonding of a concrete masonry wall by stacking the units without mortar and troweling on a stucco-like compound of white portland cement and glass fiber.





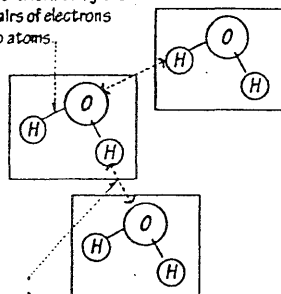
**bond**  
The attractive force by which atoms, ions, or groups of atoms are bound together in a molecule or crystalline structure. Also called chemical bond.

**ionic bond**  
A chemical bond characteristic of salts and ceramic materials, formed by the complete transfer of one or more electrons from one kind of ion to another. Also called electrovalent bond.

**positive ion**  
A positively charged ion created by electron loss. Also called cation.

**ion**  
An electrically charged atom or group of atoms formed by the loss or gain of one or more electrons.

**covalent bond**  
A chemical bond formed by the sharing of pairs of electrons between two atoms.



**hydrogen bond**  
An electrostatic bond between an electronegative atom and a hydrogen atom already linked to another electronegative atom by a covalent bond.

**molecule**  
The smallest particle of a substance that displays all of the characteristic physical and chemical properties of the substance, consisting of one or more like atoms in an element, or two or more different atoms in a compound.

**molecular weight**  
The average weight of a molecule of an element or compound calculated as the sum of the atomic weights of the molecule's constituent atoms. Also called formula weight.

**mole**  
The molecular weight of a substance expressed in grams; gram molecule. Also, mol.

**condense**  
To reduce to a denser form, as a gas or vapor to a liquid or solid state.

**heat of condensation**  
The heat liberated by a unit mass of gas at its boiling point as it condenses to a liquid.

**heat of vaporization**  
The quantity of heat required to convert a unit mass of liquid at its boiling point into vapor at the same temperature; equal to the heat of condensation.

**liquid**  
Matter distinguished from the solid or gaseous states by a characteristic readiness to flow, little or no tendency to disperse, and relatively high incompressibility.

**fluid**  
A substance, as a gas or liquid, that is capable of flowing, yields easily to pressure, and conforms to the shape of its container.

**gas**  
Matter having neither independent shape nor volume, possessing perfect molecular mobility and the tendency to expand indefinitely.

**solid**  
Matter having relative firmness, coherence of particles, or persistence of form.

**evaporate**  
To change or convert from a liquid or solid into a vapor.

**solidify**  
To change or convert from a liquid or gas into a solid.

**heat of solidification**  
The heat liberated by a unit mass of liquid at its freezing point as it solidifies.

**heat of fusion**  
The quantity of heat required to convert a unit mass of a solid at its melting point into a liquid at the same temperature; equal to the heat of solidification.

**matter**  
That which occupies space, can be perceived by the senses, and constitutes the substance of a physical body.

**shell**  
Any of up to seven spherical surfaces containing the orbits of electrons of approximately equal energy about the nucleus of an atom.

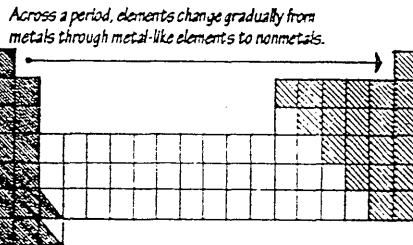
**electron**  
A fundamental particle of matter having a negative charge.

**neutron**  
A fundamental particle having no charge.

**proton**  
A positively charged particle that is a fundamental constituent of all atomic nuclei.

**periodic table**  
A tabular arrangement of the chemical elements in related groups, formerly in the order of their atomic weights and now according to their atomic numbers.

*Down a group, elements share certain characteristics and behave in a similar manner because of the way electrons are arranged in their outer shells.*



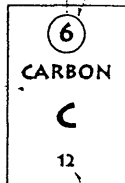
Matter having unique qualities by which it may be categorized.

**atom**  
The smallest unit of an element that can exist either alone or in combination, consisting of a nucleus of neutrons and protons surrounded by one or more electrons bound to the nucleus by electrical attraction.

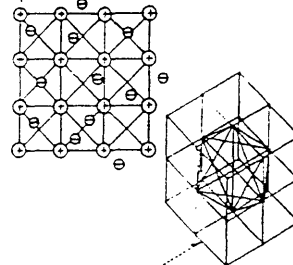
**atomic number**  
The number of protons in the nucleus of an atom of a given element, which equals the number of electrons normally surrounding the nucleus. Also called proton number.

**element**  
One of a class of substances that cannot be separated into simpler substances by chemical means, composed of atoms having an identical number of protons in each nucleus.

**atomic weight**  
The average weight of an atom of an element based on 1/12 the weight of the carbon-12 atom.



**metallic bond**  
A chemical bond characteristic of metals, produced by the sharing of valence electrons which move freely through the lattice of a usually stable crystalline structure.



**lattice**  
A regular pattern of isolated points in space showing the location of atoms, ions, or molecules in a crystalline solid.

**crystal**  
A solid having a regularly repeating internal structure of atoms, ions, or molecules and enclosed by symmetrically arranged plane surfaces.

**amorphous**  
Not crystalline in structure.

# MATERIAL

## property

An essential or distinctive attribute or quality belonging specifically to the constitution of, or found in, the behavior of a thing.

## mechanical property

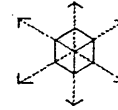
Any of the physical properties of a material that exhibit a response to applied forces.

## strength

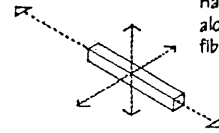
The capability of a material to resist the forces imposed on it, esp. the ability to sustain a high stress without yielding or rupturing.

## strength of materials

The study of the relationship between applied external forces and the internal effects produced by these forces in a body.



**isotropic**  
Exhibiting the same physical properties along all axes.



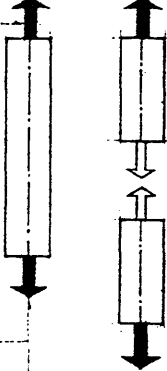
**anisotropic**  
Having different physical properties along different axes, as wood and other fibrous materials.

## tension

The act of stretching or state of being pulled apart, resulting in the elongation of an elastic body.

## tensile force

An applied force producing or tending to produce tension in an elastic body.

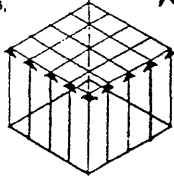


## axial force

A tensile or compressive force acting along the longitudinal axis of a structural member and at the centroid of the cross section, producing axial stress without bending, torsion, or shear. Also called axial load.

## axial stress

The tensile or compressive stress that develops to resist an axial force, assumed to be normal to and uniformly distributed over the area of the cross section. Also called direct stress, normal stress.

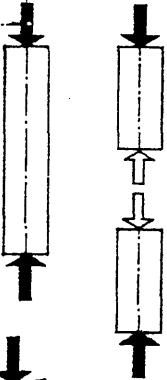


## compression

The act of shortening or state of being pushed together, resulting in a reduction in size or volume of an elastic body.

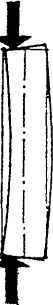
## compressive force

An applied force producing or tending to produce compression in an elastic body.



## eccentric force

A force applied parallel to the longitudinal axis of a structural member but not to the centroid of the cross section, producing bending and an uneven distribution of stresses in the section. Also called eccentric load.



## stress

The internal resistance or reaction of an elastic body to external forces applied to it, equal to the ratio of force to area and expressed in units of force per unit of cross-sectional area. Also called unit stress.

## tensile stress

The axial stress that develops at the cross section of an elastic body to resist the collinear tensile forces tending to elongate it.

## tensile strain

The elongation of a unit length of material produced by a tensile stress.

## strain

The deformation of a body under the action of an applied force. Strain is a dimensionless quantity, equal to the ratio of the change in size or shape to the original size or shape of a stressed element.

## Young's modulus

A coefficient of elasticity of a material, expressing the ratio of longitudinal stress to the corresponding longitudinal strain caused by the stress.

## Poisson's ratio

The ratio of lateral strain to the corresponding longitudinal strain in an elastic body under longitudinal stress.



## compressive stress

The axial stress that develops at the cross section of an elastic body to resist the collinear compressive forces tending to shorten it.

## compressive strain

The shortening of a unit length of material produced by a compressive stress.

## tensile test

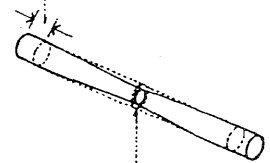
A test for determining the behavior of a material under axial tension, in which a specimen is gripped at both ends and pulled apart until rupture occurs; the most common test for structural materials.

## tensile strength

The resistance of a material to longitudinal stress, measured by the minimum amount of longitudinal stress required to rupture the material.

## elongation

A measure of the ductility of a material, expressed as the percentage increase in length of a test specimen after failure in a tensile test.



## reduction of area

A measure of the ductility of a material, expressed as the percentage decrease in cross-sectional area of a test specimen after rupturing in a tensile test.

## compression test

A test for determining the behavior of a material under axial compression, in which a specimen is crushed until fracture or disintegration occurs. The compression test is used for brittle materials since their low tensile strength is difficult to measure accurately.

## strain gauge

An instrument for measuring minute deformations in a test specimen caused by tension, compression, bending, or twisting. Also called extensometer.

## bulk modulus

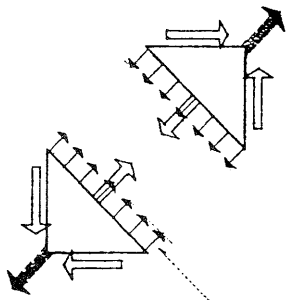
A coefficient of elasticity of a material, expressing the ratio between a pressure and the corresponding fractional change in volume produced.

## compressibility

The reciprocal of bulk modulus, equal to the ratio of the fractional change in volume to the pressure applied to a substance.

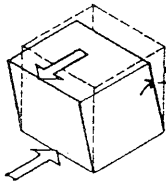
**shearing force**

An internal force tangential to the surface on which it acts, developed by a body in response to a shear force. For equilibrium of a rectangular element subject to shear, shearing in a vertical plane necessarily involves shearing in a horizontal plane, and vice versa.



**shearing stress**

The force per unit area developed along a section of an elastic body to resist a shear force. Also called shear stress, tangential stress.



**shearing strain**

The lateral deformation developed in a body in response to shearing stresses, defined as the tangent of the skew angle of the deformation. Since this skew angle is always very small, shearing strain is a pure number very nearly equal to the skew angle in radians. Also called shear strain.

**shear modulus**

A coefficient of elasticity of a material, expressing the ratio between shearing stress and the corresponding shearing strain produced by the stress. Also called modulus of rigidity, modulus of torsion.

**shear**

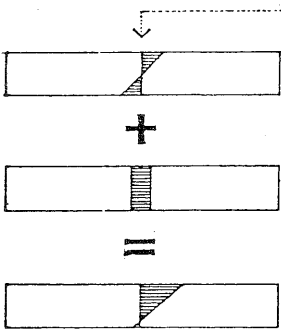
The lateral deformation produced in a body by an external force that causes one part of the body to slide relative to an adjacent part in a direction parallel to their plane of contact.

**shear force**

An applied force producing or tending to produce shear in a body.

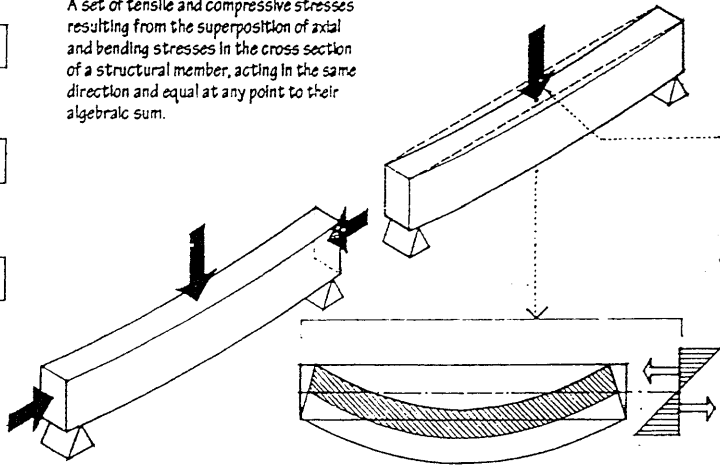
**combined stresses**

A set of tensile and compressive stresses resulting from the superposition of axial and bending stresses in the cross section of a structural member, acting in the same direction and equal to their algebraic sum.



**bending**

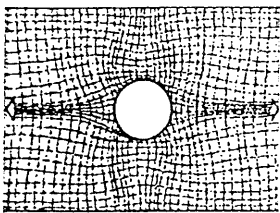
The bowing of an elastic body as an external force is applied transversely to its length. Bending is the structural mechanism that enables a load to be channeled in a direction perpendicular to its application.



**transverse force**

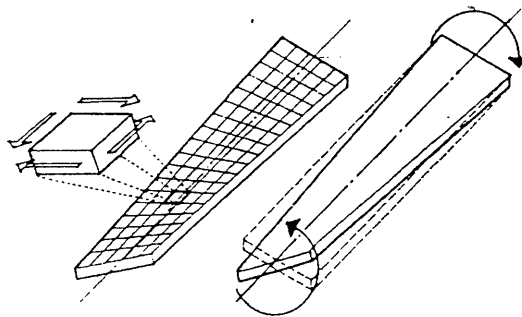
A force applied perpendicular to the length of a structural member, producing bending and shear. Also called transverse load.

\* See beam for bending stresses.



**stress concentration**

An increase in stress that develops at discontinuities or flaws in a material. Stress concentrations in brittle materials develop cracks which propagate until failure. In ductile materials, stress concentrations develop local deformations which serve to redistribute and relieve the stresses.



**torque**

The moment of a force system that causes or tends to cause rotation or torsion.

**torsion**

The twisting of an elastic body about its longitudinal axis caused by two equal and opposite torques, producing shearing stresses in the body.

# MATERIAL

## stress-strain diagram

A graphic representation of the relationship between unit stress values and the corresponding unit strains for a specific material.

### elastic range

The range of unit stresses for which a material exhibits elastic deformation.

### deformation

A change in the shape or dimensions of a body or structure resulting from stress.

### elastic deformation

A temporary change in the dimensions or shape of a body produced by a stress less than the elastic limit of the material.

### brittleness

The property of a material that causes it to rupture suddenly under stress with little evident deformation. Since brittle materials lack the plastic behavior of ductile materials, they can give no advance warning of impending failure.

### proportional limit

The stress beyond which the ratio of stress to strain for a material no longer remains constant.

### stiffness

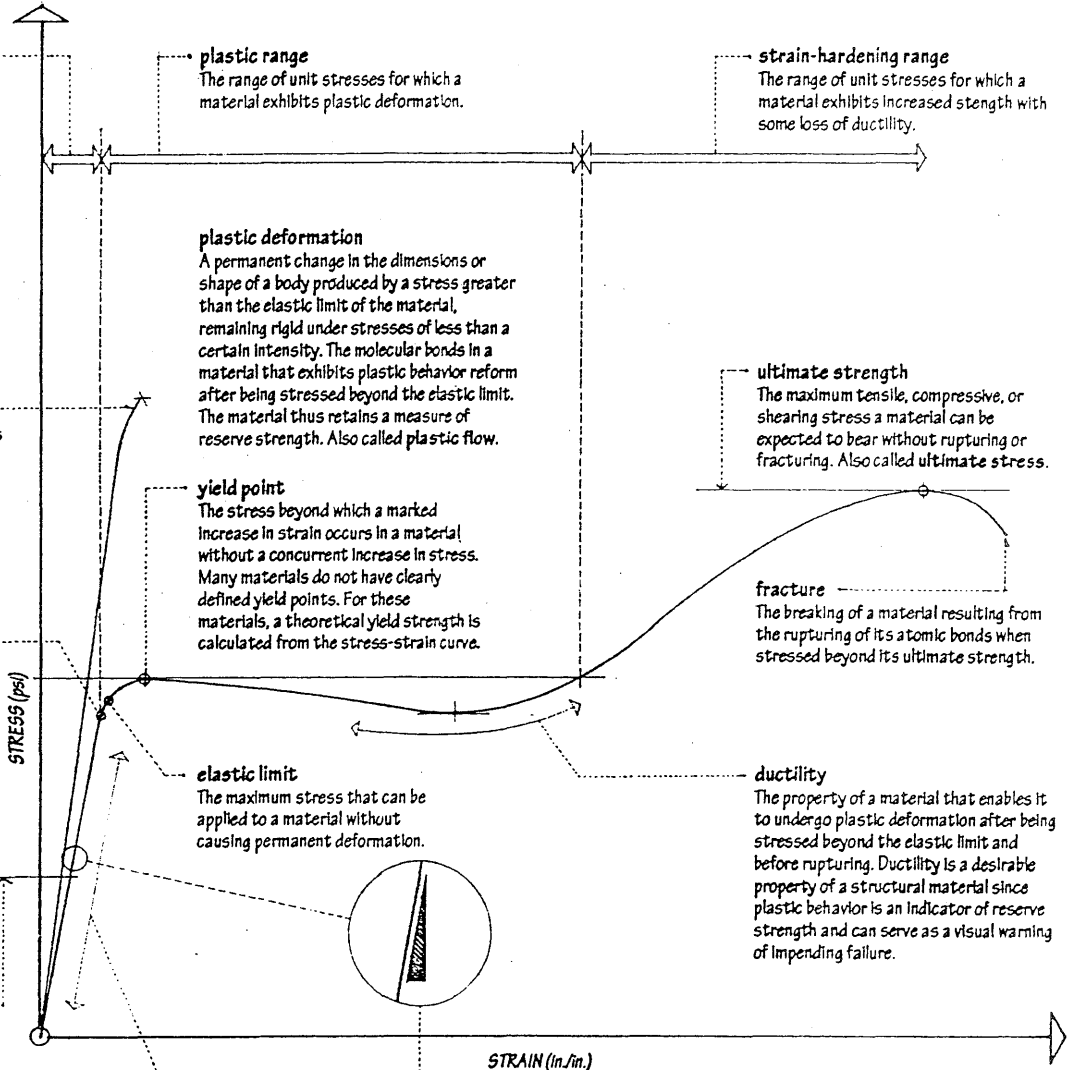
A measure of a material's resistance to deformation when stressed within its elastic range.

### allowable stress

The maximum unit stress permitted for a material in the design of a structural member, usually a fraction of the material's elastic limit, yield strength, or ultimate strength. The allowable stresses for various materials are specified by building codes, engineering societies, and trade associations, based on specifications and methods of testing established by the American Society for Testing and Materials. Also called allowable unit stress, working stress.

### yield strength

The stress necessary to produce a specified limiting permanent set in a material, usually 0.2% of its original length when tested in tension. Yield strength is used to determine the limit of usefulness of a material having a poorly defined yield point. Also called proof stress.



### elasticity

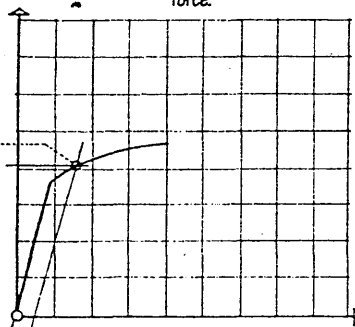
The property of a material that enables it to deform in response to an applied force and to recover its original size and shape upon removal of the force.

### modulus of elasticity

A coefficient of elasticity of a material, expressing the ratio between a unit stress and the corresponding unit strain caused by the stress, as derived from Hooke's law and represented by the slope of the straight-line portion of the stress-strain diagram. Also called coefficient of elasticity, elastic modulus.

### Hooke's law

The law stating that the stress on a body is directly proportional to the strain produced, provided the stress does not exceed the elastic limit of the material.

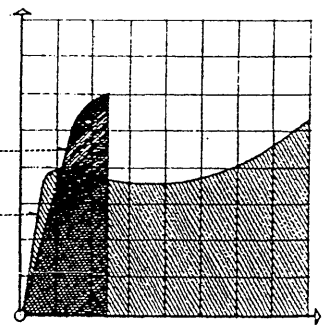


### permanent set

The inelastic strain remaining in a material after complete release of the stress producing the deformation.

strong but brittle

ductile and tough

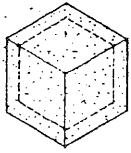


### toughness

The property of a material that enables it to absorb energy before rupturing, represented by the area under the stress-strain curve derived from a tensile test of the material. Ductile materials are tougher than brittle materials.

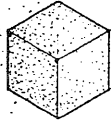
**moisture expansion**

An increase in the bulk of a material caused by the absorption of water or water vapor. Also called bulking.



**absorption**

The taking in or reception of a gas or liquid by molecular or chemical action.



**adsorption**

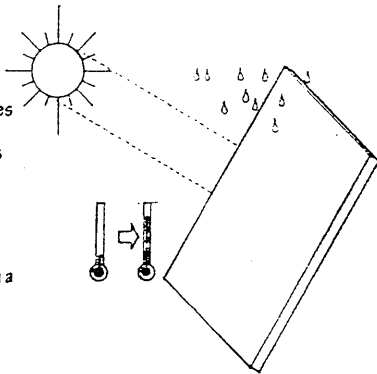
The adhesion of a thin, condensed layer of gas, liquid, or dissolved substance to the surface of a solid, usually without any physical or chemical change in the material.

**weatherability**

The property of a material that enables it to retain its appearance and integrity when exposed to the effects of sun, wind, moisture, and changes in temperature.

**weatherometer**

A device for determining the weather resistance of a material by subjecting a test specimen to accelerated weathering.



**accelerated weathering**

A process for exposing a material to ultraviolet rays, water sprays, and heating elements in order to simulate the long-term effects of sun, rain, and temperature changes. Also called accelerated aging.

**strain-rate effect**

The brittle behavior an increased rate of load application can cause in a normally ductile material.

**temperature effect**

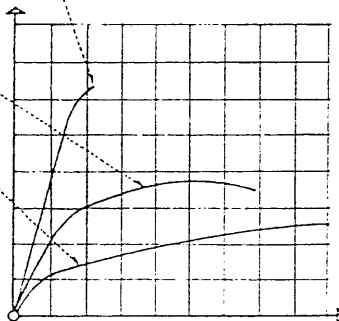
The brittle behavior low temperatures can cause in a normally ductile material.

**stress relaxation**

The time-dependent decrease in stress in a constrained material under a constant load.

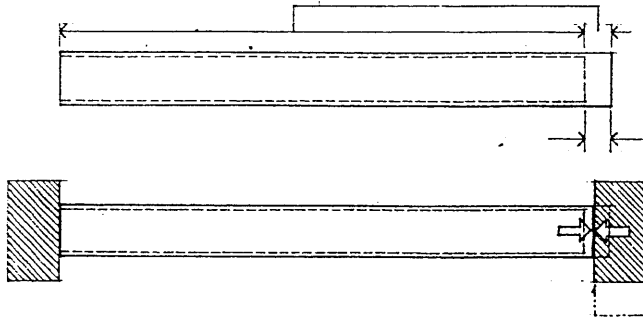
**creep**

The gradual and permanent deformation of a body produced by a continued application of stress or prolonged exposure to heat. Creep deflection in a concrete structure continues over time and can be significantly greater than the initial elastic deflection.



**coefficient of expansion**

The fractional change in length, area, or volume of a material per unit change in temperature at a given constant pressure. Also called expansivity.



**dimensional stability**

The property of a material that enables it to maintain its original shape and dimensions when subjected to changes in temperature or humidity.

**kinetic theory of heat**

The theory that the temperature of a substance increases with an increase of the average kinetic energy of its particles when heat is absorbed.

**thermal expansion**

An increase in length, area, or volume of a material caused by a rise in temperature.

**thermal contraction**

A decrease in length, area, or volume of a material caused by a drop in temperature.

**thermal stress**

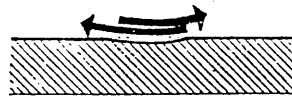
The tensile or compressive stress developed in a material constrained against thermal expansion or contraction.

**thermal shock**

The sudden stress a rapid change in temperature can produce in a material.

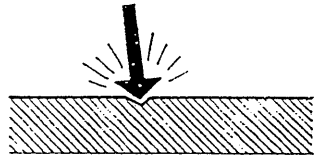
**abrasion resistance**

The property of a material that enables it to resist being worn away by friction when rubbed with another object. Abrasion resistance is a measure of toughness rather than hardness and is a necessary quality of flooring materials and surface finishes.



**hardness**

The property of a material that enables it to resist deformation by compression, indentation, or penetration.



**abrasion-resistance index**

A measure of the abrasion resistance of a material, commonly expressed as the depth of penetration or material loss after testing with a weighted abrasive wheel for a specified number of cycles.

**Mohs' scale**

A scale for measuring the hardness of a mineral. Its degrees, in increasing hardness, are: 1, talc; 2, gypsum; 3, calcite; 4, fluorite; 5, apatite; 6, feldspar; 7, quartz; 8, topaz; 9, sapphire; 10, diamond.

**Brinell number**

A measure of the hardness of a material, determined by pressing a standard steel ball into a test piece using a standard force and dividing the load by the area of indentation. The higher the number, the harder the material.

**Rockwell number**

A measure of the hardness of a material, determined by indenting a test piece with a conoidal diamond indenter, or with a standard steel ball, under two successive loads and measuring the net increase in depth of the impressions: the higher the number, the harder the material.

**Vickers number**

A measure of the hardness of a material, determined by indenting a test piece with the point of a diamond using a known force and dividing the load by the surface area of indentation: the higher the number, the harder the material.

**fatigue**

The weakening or failure of a material at a stress below the elastic limit when subjected to a repeated series of stresses.

**fatigue limit**

The maximum stress to which a material can be subjected for an indefinite number of cycles without failing.

**fatigue ratio**

The ratio between the fatigue limit and the tensile strength of a material. Also called endurance ratio.

# MEASURE

A unit or standard of measurement used to ascertain the dimensions, quantity, or capacity of something.

## metric system

A decimal system of weights and measures, adopted first in France but now widespread and universally used in science.

## International System of Units

An internationally accepted system of coherent physical units, using the meter, kilogram, second, ampere, kelvin, and candela as the basic units of the fundamental quantities of length, mass, time, electric current, temperature, and luminous intensity.

## length

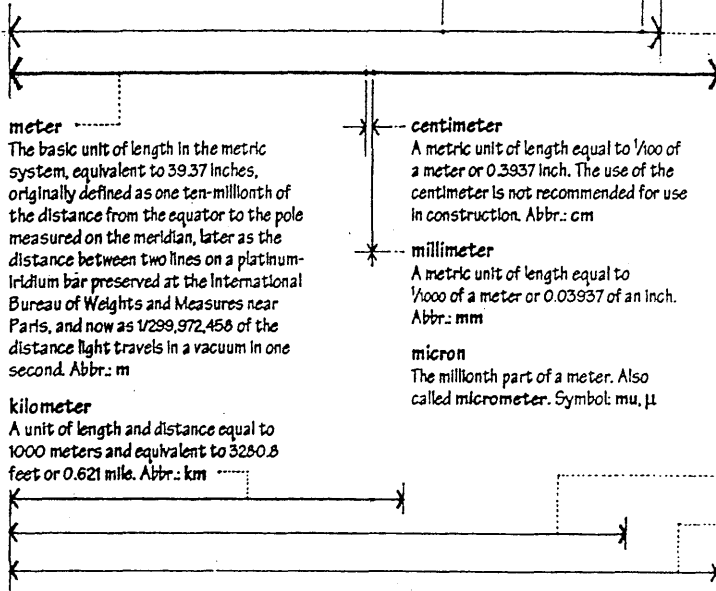
The extent of anything measured along its greatest dimension.

## conversion table

A tabular arrangement of the equivalent values of the weight or measure units of different systems.

## SI unit

One of the basic units of the International System of Units.



## meter

The basic unit of length in the metric system, equivalent to 39.37 inches, originally defined as one ten-millionth of the distance from the equator to the pole measured on the meridian, later as the distance between two lines on a platinum-iridium bar preserved at the International Bureau of Weights and Measures near Paris, and now as  $1/299,972,458$  of the distance light travels in a vacuum in one second. Abbr.: m

## kilometer

A unit of length and distance equal to 1000 meters and equivalent to 3280.8 feet or 0.621 mile. Abbr.: km

## are

A metric unit of area equal to  $1/100$  of a hectare, 100 square meters, or 119.6 square yards. Abbr.: a

## hectare

A metric unit of area equal to 10,000 square meters or 2.47 acres. Abbr.: ha

## scale

A system of ordered marks laid down at known intervals and used as a standard reference in measuring.

## foot

A unit of length originally derived from the length of the human foot, divided into 12 inches and equal to 304.8 millimeters. Abbr.: ft.

## inch

A unit of length,  $1/12$ th of a foot, equivalent to 25.4 millimeters. Abbr.: in.

## mil

A unit of length equal to 0.001 of an inch or 0.0254 mm, used in measuring the diameter of wires and the thickness of very thin sheet materials.

## yard

A unit of length equal to 3 feet or 36 inches, and equivalent to 0.9144 meter. Abbr.: yd.

## rod

A unit of length equal to  $5/2$  yards or  $16\frac{1}{2}$  feet, and equivalent to 5.029 meters.

## mile

A unit of distance on land equal to 5280 feet or 1760 yards, and equivalent to 1.609 km. Also called statute mile. Abbr.: mi

## nautical mile

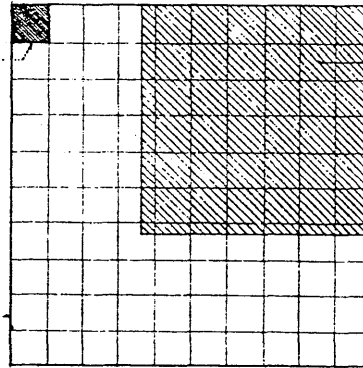
A unit of distance used in sea or air navigation, equal to 1.852 kilometers or about 6,076 feet. Also called air mile.

## square measure

A unit or system of units for measuring area, derived from units of linear measure.

## area

A quantitative measure of a plane or curved surface.



## acre

A unit of land area equal to  $1/640$  of a square mile, 4840 square yards, 43,560 square feet, or 4047 square meters.

## circular mil

A unit used principally for measuring the cross-sectional area of wire, equal to the area of a circle having a diameter of one mil.

## cubic measure

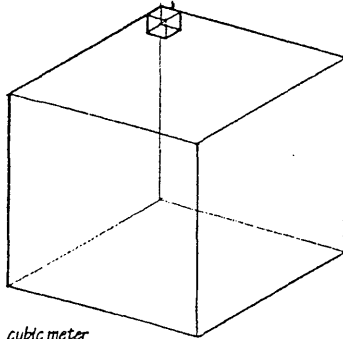
A unit or system of units for measuring volume or capacity, derived from units of linear measure.

## volume

The size or extent of a three-dimensional object or region of space, measured in cubic units.

## liter

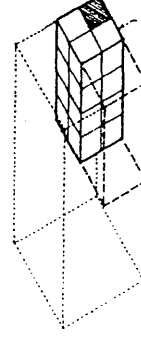
A metric unit of capacity equal to  $1/1000$  of a cubic meter or 61.02 cubic inches. Abbr.: L



cubic meter

## milliliter

A metric unit of capacity equal to  $1/1000$  of a liter or 0.0162 cubic inch. Abbr.: ml



## fluid ounce

A unit of liquid capacity equal to 1.805 cubic inches or 29.573 milliliters. Abbr.: fl oz

## pint

A unit of liquid capacity equal to 16 fluid ounces, 28.875 cubic inches, or 0.473 liter. Abbr.: pt.

## quart

A unit of liquid capacity equal to two pints, 57.75 cubic inches, or 0.946 liter. Abbr.: qt.

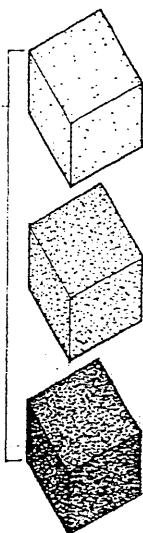
## gallon

A unit of liquid capacity equal to 4 quarts, 231 cubic inches, or 3.785 liters. Abbr.: gal.

**density**  
The mass of a substance per unit volume.

**specific volume**  
The reciprocal of density, equal to volume per unit mass.

**specific gravity**  
The ratio of the density of a substance to the density of another substance taken as a standard, usually distilled water for liquids and solids, and air or hydrogen for gases.

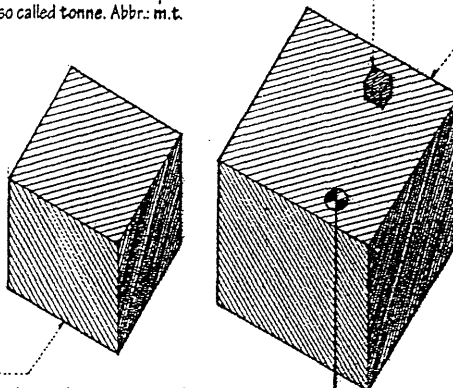


**metric ton**  
A unit of mass equal to 1,000 kilograms and equivalent to 2,204.62 avoirdupois pounds. Also called tonne. Abbr.: m.t.

**gram**  
A metric unit of mass equal to 1/1000 of a kilogram or 0.035 ounce. Abbr.: g

**mass**  
A measure of a body's inertia, as determined by the quantity of material it contains and its weight in a field of constant gravitational acceleration. Abbr.: M

**kilogram**  
The base SI unit of mass, equal to the mass of a platinum-iridium cylinder kept at the International Bureau of Weights and Measures near Paris; equivalent to 2.205 avoirdupois pounds. Abbr.: kg



**pound**  
A unit of weight equal to 16 ounces and equivalent to 0.453 kg. Abbr.: lb.

**kip**  
A unit of weight equal to 1000 pounds or 453.6 kg.

**ton**  
A unit of weight equal to 2,000 pounds or 0.907 metric ton. Also called short ton.

**weight**  
The gravitational force exerted by the earth on a body, equal to the mass of the body times the local acceleration of gravity.

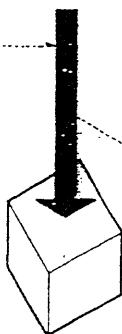
**gravity**  
The central force of attraction exerted by the mass of the earth on a body near its surface.

**acceleration of gravity**  
The acceleration of a freely falling body in the earth's gravitational field, having an approximate value at sea level of 32 ft. (9.8 m) per second per second.

**pound**  
A unit of force equal to the weight of a one-pound mass under the acceleration of gravity. Abbr.: lb

**newton**  
The SI unit of force equal to the force required to accelerate a mass of one kilogram at the rate of one meter per second per second. Abbr.: N

**kilogram**  
A unit of force and weight equal to the weight of a kilogram mass under the acceleration of gravity. Abbr.: kg

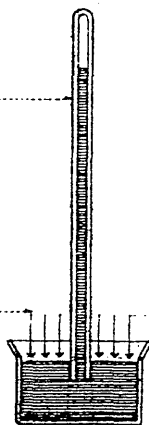


**atmosphere**  
A unit of pressure equal to the normal pressure of the air at sea level, equal to  $1.01325 \times 10^5 \text{ N/m}^2$  or about 14.7 pounds per square inch. Abbr.: atm.

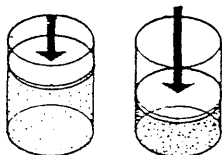
**standard atmosphere**  
A standard unit of atmospheric pressure, having a value of 29.92 in. (760 mm) of mercury.

**atmospheric pressure**  
The pressure exerted by the earth's atmosphere at any given point, usually expressed in terms of the height of a column of mercury. Also called barometric pressure.

**barometer**  
An instrument for measuring atmospheric pressure, used in weather forecasting and determining elevation.

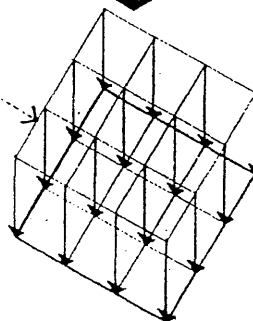


**Boyle's law**  
The principle that, at relatively low pressures and a fixed temperature, the pressure of a confined ideal gas varies inversely with its volume.



**foot-pound**  
A unit of energy equal to the work done when the point of application of a force of one pound moves through a distance of one foot in the direction of the force. Abbr.: ft-lb

**inch-pound**  
One-twelfth of a foot-pound. Abbr.: in-lb



**pressure**  
The force exerted over a surface, measured as force per unit area.

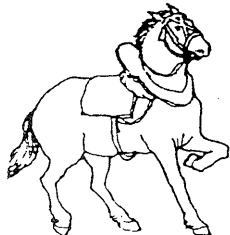
**pascal**  
The SI unit of pressure equal to one newton per square meter. Abbr.: Pa

**energy**  
The work a physical system is capable of doing in changing from its actual state to a specified reference state.

**joule**  
The SI unit of work or energy equal to the work done when the point of application of a force of one newton moves through a distance of one meter in the direction of the force; approximately 0.7375 ft-lb. Also called newton-meter. Abbr.: J

**watt-hour**  
A unit of energy equal to energy of one watt operating for one hour and equivalent to 3,600 joules. Abbr.: Wh

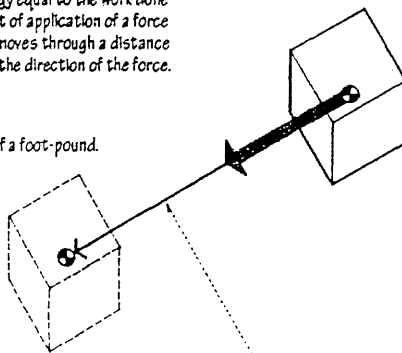
**horsepower**  
A unit of power equal to 550 foot-pounds per second or 745.7 watts. Abbr.: hp



**mechanical equivalent of heat**  
The number of units of work or energy equal to one unit of heat, as 778.2 ft-lb, which equals one Btu, or 4.1858 joules, which equals one calorie.

**power**  
The amount of work done or energy transferred per unit of time, usually expressed in watts or horsepower.

**work**  
The transfer of energy produced by the motion of the point of application of a force, equal to the product of the component of the force that acts in the direction of the motion of the point of action and the distance through which the point of application moves.

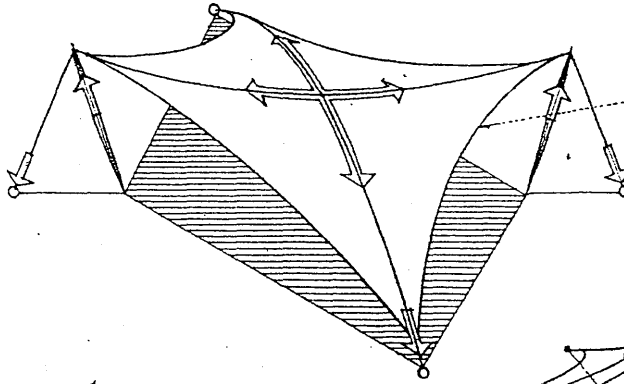


# MEMBRANE

A thin, flexible surface that carries loads primarily through the development of tensile stresses.

## tent structure

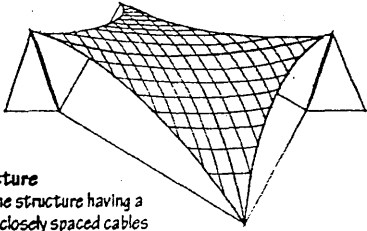
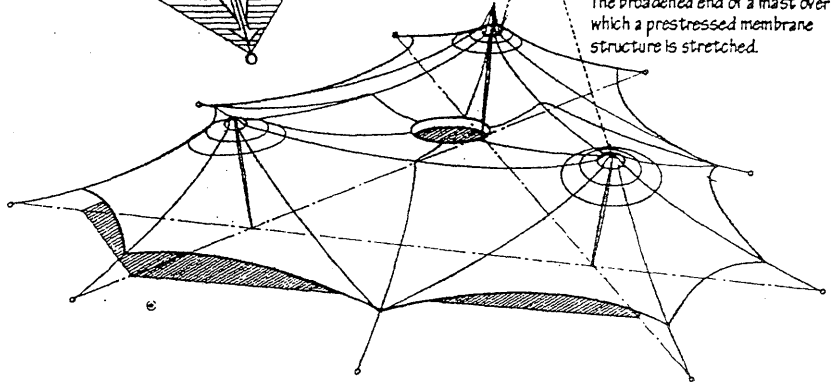
A membrane structure prestressed by externally applied forces so that it is held completely taut under all anticipated load conditions. To avoid extremely high tensile forces, a membrane structure should have relatively sharp curvatures in opposite directions.



**reinforcing edge cable**  
A cable stiffening the free edges of a prestressed membrane structure.

**cable loop**  
A reinforcing edge cable tied to the mast support of a membrane structure.

**distribution cap**  
The broadened end of a mast over which a prestressed membrane structure is stretched.

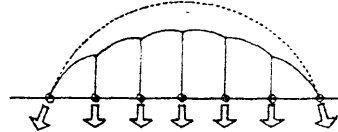
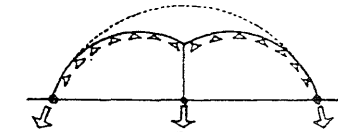
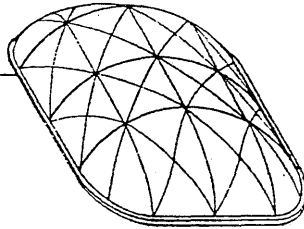
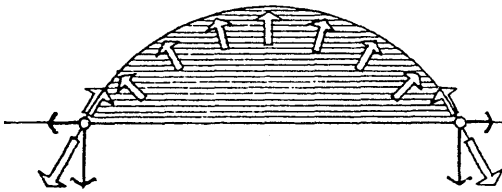


## net structure

A membrane structure having a surface of closely spaced cables instead of a fabric material.

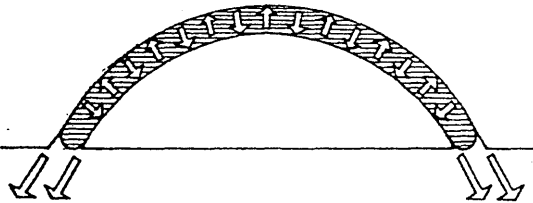
## pneumatic structure

A membrane structure that is placed in tension and stabilized by the pressure of compressed air.



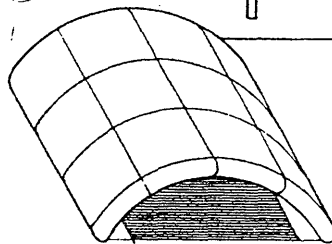
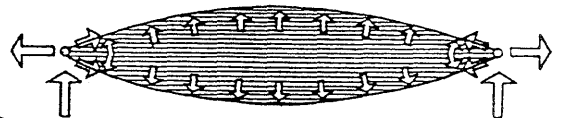
## air-supported structure

A pneumatic structure consisting of a single membrane supported by an internal air pressure slightly higher than normal atmospheric pressure, and securely anchored and sealed along the perimeter to prevent leaking. Air locks are required at entrances to maintain the internal air pressure.



## cable-restrained pneumatic structure

An air-supported structure that uses a net of cables placed in tension by the inflating force to restrain the membrane from developing its natural inflated profile.

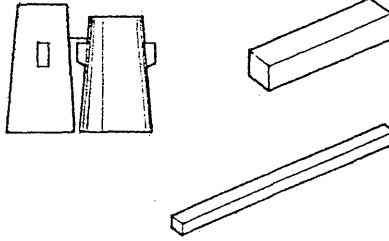


## air-inflated structure

A pneumatic structure supported by pressurized air within inflated building elements, which are shaped to carry loads in a traditional manner, while the enclosed volume of building air remains at normal atmospheric pressure. The tendency for a double-membrane structure to bulge in the middle is restrained by a compression ring or by internal ties or diaphragms.



**ingot**  
A mass of metal cast into a convenient shape for storage or transportation before further processing.



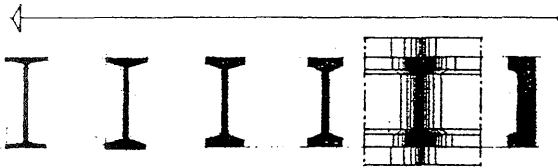
**blank**  
A piece of metal ready to be drawn, pressed, or machined into a finished object.

**bloom**  
A bar of steel reduced from an ingot to dimensions suitable for further rolling.

**blooming mill**  
A mill for rolling ingots into blooms.

**billet**  
A narrow, generally square, bar of steel, forged or hot-rolled from an ingot or bloom.

Any of a class of elementary substances, as gold, silver, or copper, all of which are crystalline when solid and many of which are characterized by opacity, ductility, conductivity, and a unique luster when freshly fractured.



**hot-roll**  
To roll metal at a heat high enough to permit recrystallization.

**hot-rolled finish**  
The dark, oxidized, relatively rough finish obtained by rolling metal while hot.

**scale**  
An oxide occurring in a scaly form on the surface of metal when brought to a high temperature.

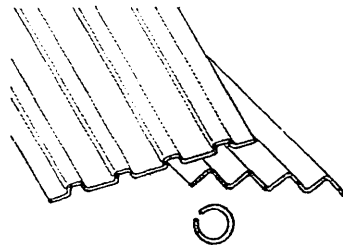
**mill scale**  
A loose coating of iron oxide that forms on iron or steel during hot-rolling. Mill scale increases the bond between steel and concrete in reinforced concrete or in structural steelwork encased in concrete for fire protection.

**die casting**  
The process or product of forcing molten metal into a metallic mold under hydraulic pressure to give it a particular shape or form.

**casting**  
The process or product of forming a material into a particular shape by pouring it into a mold in a fluid state and letting it harden.

**mold**  
A hollow form or matrix for giving a particular shape to something in a molten or plastic state.

**forge**  
To form metal by heating and hammering.



**heat treatment**  
The controlled heating and cooling of a metal to develop certain desirable physical or mechanical properties.

**anneal**  
To remove internal stress from metal or glass by heating to a temperature below that of recrystallization and then gradually cooling in a liquid or air, esp. to make the material more ductile.

**quench**  
To rapidly cool a heated metal by immersion in water, esp. to increase its hardness.

**temper**  
To strengthen or toughen a metal by reheating at a lower temperature and slowly cooling the material.

**stress relieving**  
The tempering of a metal at a temperature high enough to relieve residual stresses, followed by slow, uniform cooling.

**residual stress**  
Microscopic stress in a metal resulting from nonuniform thermal changes, plastic deformation, or other causes aside from external forces or applications of heat.

**case-harden**  
To make the outside surface of an iron-based alloy hard by carburization and heat treatment, leaving the interior tough and ductile.

**cold-roll**  
To roll metal at a temperature below that at which recrystallization occurs, so as to increase its tensile strength or improve its surface finish.

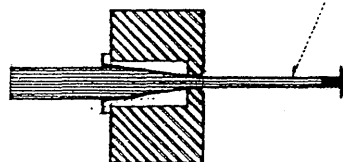
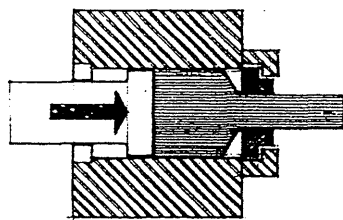
**mill finish**  
The striated finish that cold rolling or extrusion imparts to a metal surface.

**extrusion**  
The process or product of forming a metal or plastic with a desired cross section by forcing it through a die with a pressure ram.

**cold-draw**  
To draw metal through a set of dies to reduce its cross-sectional area without preheating, as in the fabrication of wire or tubing.

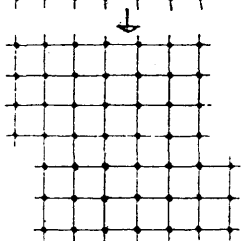
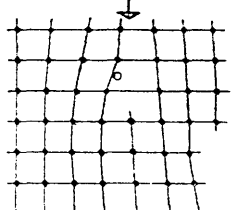
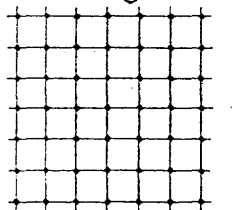
**drawn finish**  
A smooth, bright finish produced by drawing metal through a die.

**die**  
A steel block or plate having small conical holes through which metal or plastic is extruded or drawn for shaping.



**hot-working**  
The working of a metal at a temperature high enough to permit recrystallization.

**recrystallize**  
To acquire a new granular structure with new crystals because of plastic deformation, as when worked after being heated.



**cold-working**  
The working of metal below the temperature at which recrystallization occurs, as in drawing, pressing, or stamping.

# METAL

## ferrous metal

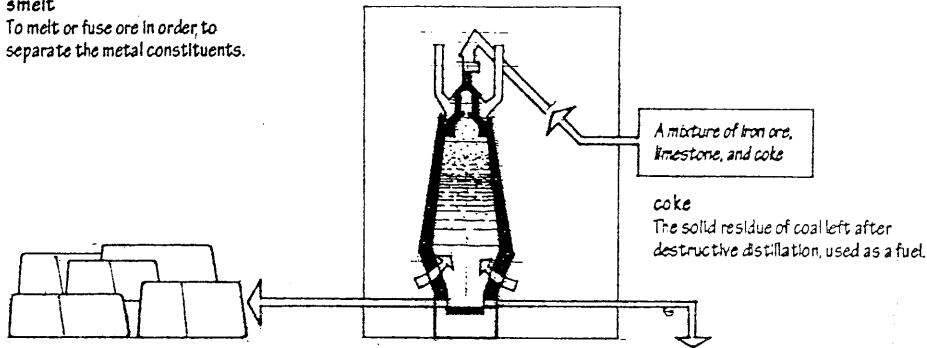
A metal containing iron as a principal element.

## iron

A malleable, ductile, magnetic, silver-white metallic element from which pig iron and steel are made. Symbol: Fe

## smelt

To melt or fuse ore in order to separate the metal constituents.



A mixture of iron ore, limestone, and coke

**coke**  
The solid residue of coal left after destructive distillation, used as a fuel.

## pig iron

Crude iron that is drawn from a blast furnace and cast into pigs in preparation for conversion into cast iron, wrought iron, or steel.

## pig

An oblong mass of metal that has been poured while still molten into a mold of sand, esp. such a mass of iron from a blast furnace.

## blast furnace

A large vertical furnace for smelting iron from ore, in which combustion is intensified by a continuous blast of air through the fuel.

## blast-furnace slag

Slag left as a residue by the smelting of iron ore in a blast furnace.

## slag

The vitrified matter left as a residue from the smelting of a metallic ore. Also called cinder.

## cast iron

A hard, brittle, nonmalleable iron-based alloy containing 2.0% to 4.5% carbon and 0.5% to 3% silicon, cast in a sand mold and machined to make many building products.

## malleable cast iron

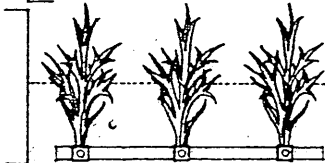
Cast iron that has been annealed by transforming the carbon content into graphite or removing it completely.

## malleable

Capable of being shaped or formed by hammering or by pressure from rollers.

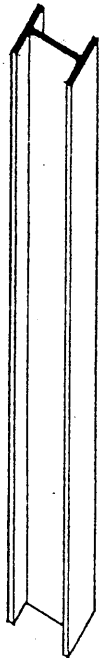
## wrought iron

A tough, malleable, relatively soft iron that is readily forged and welded, having a fibrous structure containing approximately 0.2% carbon and a small amount of uniformly distributed slag.



## steel

Any of various iron-based alloys having a carbon content less than that of cast iron and more than that of wrought iron, and having qualities of strength, hardness, and elasticity varying according to composition and heat treatment.



## carbon steel

Ordinary, unalloyed steel in which the residual elements, as carbon, manganese, phosphorus, sulfur, and silicon, are controlled. Any increase in carbon content increases the strength and hardness of the steel but reduces its ductility and weldability.

## carbon

A nonmetallic element occurring in a pure state as diamond and graphite, or as a constituent of coal and petroleum. Symbol: C

## mild steel

A low-carbon steel containing from 0.15% to 0.25% carbon. Also called soft steel.

## medium steel

A carbon steel containing from 0.25% to 0.45% carbon.

## hard steel

A high-carbon steel containing from 0.45% to 0.85% carbon.

## spring steel

A high-carbon steel containing 0.85% to 1.80% carbon.



## alloy steel

Carbon steel to which various elements, as chromium, cobalt, copper, manganese, molybdenum, nickel, tungsten, or vanadium, have been added in a sufficient amount to obtain particular physical or chemical properties.

## alloy

A substance composed of two or more metals, or of a metal and a nonmetal, intimately mixed, as by fusing or electrodeposition.

## base metal

The principal metal of an alloy or a piece underlying a coating of another metal.

## stainless steel

An alloy steel containing a minimum of 12% chromium, sometimes with nickel, manganese, or molybdenum as additional alloying elements, so as to be highly resistant to corrosion.

## high-strength low-alloy steel

Any of a group of low-carbon steels containing less than 2% alloys in a chemical composition specifically developed for increased strength, ductility, and resistance to corrosion.

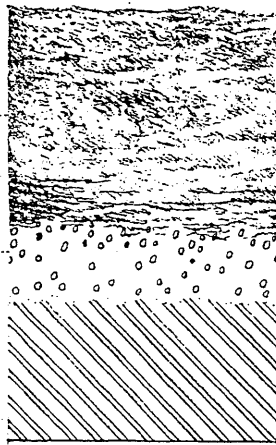
## weathering steel

A high-strength, low-alloy steel that forms an oxide coating when exposed to rain or moisture in the atmosphere, which adheres firmly to the base metal and protects it from further corrosion. Structures using weathering steel should be detailed to prevent the small amounts of oxide carried off by rainwater from staining adjoining materials.

**rust**  
The reddish brittle coating formed on the surface of iron esp. when exposed to moisture and air, consisting essentially of hydrated ferric oxide formed by oxidation.

**oxidation**  
The process or result of combining with oxygen to form an oxide.

**oxide**  
A binary compound of oxygen with another element.



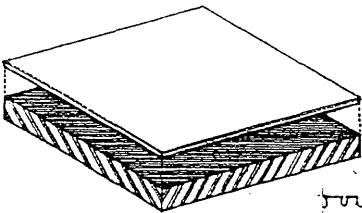
**noble metal**  
A metal, as gold, silver, and mercury, that resists oxidation when heated in air, and solution by inorganic acids.

- cathode (most noble) ⊖
- GOLD & PLATINUM
  - TITANIUM
  - SILVER
  - STAINLESS STEEL
  - BRONZE
  - COPPER
  - BRASS
  - NICKEL
  - TIN
  - LEAD
  - IRON & STEEL
  - CADMIUM
  - ALUMINUM
  - ZINC
- anode ⊕
- MAGNESIUM

**corrosion**  
The gradual deterioration of metal by chemical action, as when exposed to weather, moisture, or other corroding agents.

**galvanic corrosion**  
An accelerated corrosive action that takes place when dissimilar metals are in contact in the presence of an electrolyte.

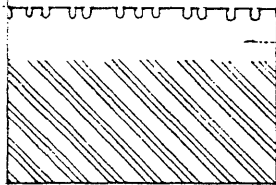
**galvanic series**  
A list of metals arranged in order from least noble to most noble. The farther apart two metals are on the list, the more susceptible the least noble one is to corrosive deterioration.



**cladding**  
The process or product of bonding one metal to another, usually to protect the inner metal from corrosion.

**pickle**  
An acid or other chemical solution in which a metal object is dipped to remove oxide scale or other adhering substances.

**bonderize**  
To coat steel with an anticorrosive phosphate solution in preparation for the application of paint, enamel, or lacquer.



**sacrificial anode** ←  
An anode that is attached to a metal object subject to electrolysis and is decomposed instead of the object.

**cathodic protection**  
The protection of ferrous metals against electrolysis by the attachment of sacrificial anodes. Also called electrolytic protection.

**anodize**  
To coat a metal, esp. aluminum or magnesium, with a hard, noncorrosive film by electrolytic or chemical action.

**chrome**  
To coat or plate a metal surface with a compound of chromium. Also called chromeplate.

**chromium**  
A lustrous, hard, brittle metallic element used in alloy steels for hardness and corrosion resistance, and for electroplating other metals.

**galvanize**  
To coat metal, esp. iron or steel, with zinc, esp. to immerse in molten zinc to produce a coating of zinc-iron alloy.

**hot-dip galvanizing**  
The protective coating of ferrous metal by dipping in a bath of molten zinc.

**galvanized iron**  
Iron coated with zinc to prevent rust.

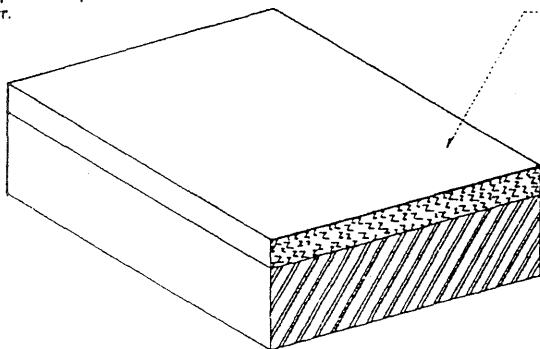
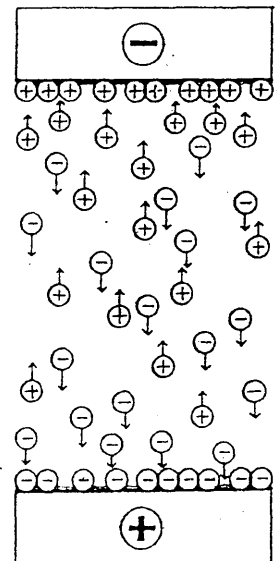
**zinc**  
A ductile, crystalline, bluish-white metallic element, used for galvanizing iron and steel and in making other alloys. Symbol: Zn

**tinplate**  
Thin iron or steel sheet plated with tin for protection against oxidation.

**tin**  
A lustrous, low-melting, bluish-white metallic element that is malleable and ductile at ordinary temperatures and used in plating and in making alloys and soft solders. Symbol: Sn

**electroplate**  
To plate with an adherent metallic coating by electrolysis, usually to increase the hardness, improve the durability, or enhance the appearance of the base metal.

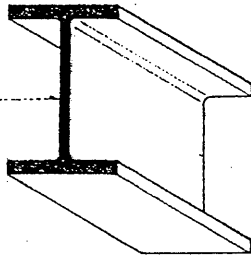
**electrolysis**  
The producing of chemical changes by the passage of an electric current through an electrolyte, with subsequent migration of positively and negatively charged ions to the negative and positive electrodes.



# METAL

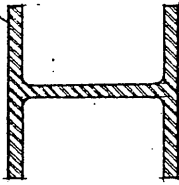
## W-shape

A hot-rolled structural steel section having an H-shape with wide parallel flanges, designated by the prefix W followed by the size and weight of the member. Also called wide flange.



## M-shape

A hot-rolled structural steel shape similar to but not classified as a W-shape, designated by the prefix M followed by the size and weight of the member.

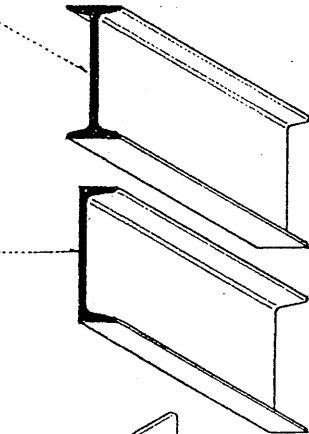


## HP-shape

A hot-rolled structural steel section similar to a W-shape but having flanges and web of equal thickness and typically used as a load-bearing pile, designated by the prefix HP followed by the size and weight of the member.

## S-shape

A hot-rolled structural steel section having an I-shape with sloped inner flange surfaces, designated by the prefix S followed by the size and weight of the member. Also called American standard beam.



## American standard channel

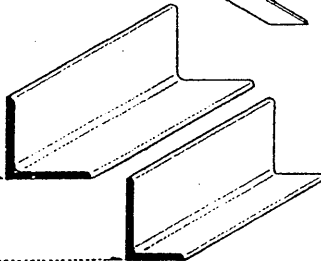
A hot-rolled structural steel section having a rectangular C-shape with sloped inner flange surfaces, designated by the prefix C followed by the size and weight of the member.

## Miscellaneous channel

A hot-rolled structural steel section similar to a C-shape but designated by the prefix MC followed by the size and weight of the member.

## angle

A hot-rolled structural steel section having an L-shape, designated by the prefix L followed by the length of each leg and their thickness. Also called angle iron.



## equal leg angle

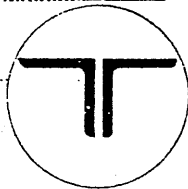
An angle iron having legs of equal length.

## unequal leg angle

An angle iron having legs of unequal length.

## double angle

A structural member consisting of a pair of angles joined back to back. The parallel legs may be in contact or slightly separated.



## structural tee

A structural steel section cut from a W-, S-, or M-shape and having a T-shape. It is designated by the prefix WT, ST, or MT, depending on the section from which it is cut, followed by the size and weight of the member.

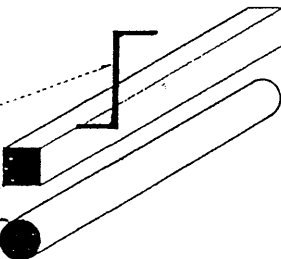


## tee

A rolled metal bar having a T-shaped cross section. Also called T-bar.

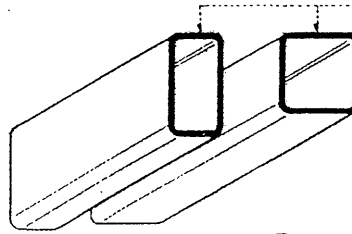
## zee

A rolled metal bar having a Z-shaped cross section with internal right angles. Also called Z-bar.



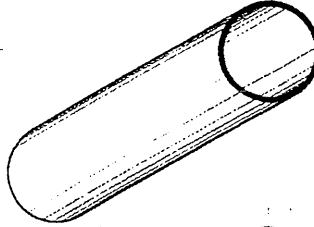
## bar

A long, solid piece of metal, esp. one having a square, rectangular, or other simple cross-sectional shape.



## structural tubing

A hollow structural steel shape of square, rectangular, or circular cross section. It is designated by the prefix ST followed by the side dimensions or diameter and the wall thickness.



## standard pipe

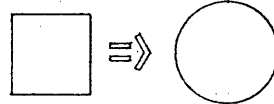
A structural steel pipe of standard weight and wall thickness, designated as Pipe (nominal inside diameter) Std.

## extra-strong pipe

A structural steel pipe having increased wall thickness for greater strength, designated as Pipe (nominal inside diameter) X-Strong.

## double-extra-strong pipe

A structural steel pipe having a wall thickness greater than that of extra-strong pipe, designated as Pipe (nominal inside diameter) XX-Strong.



## equivalent round

The diameter of a circle having a circumference equal to the perimeter of a noncircular tube.

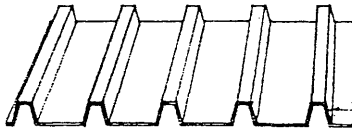


## plate

A thin, flat sheet or piece of metal, esp. one of uniform thickness.

## checkered plate

A steel or cast-iron plate having a wafflelike pattern.

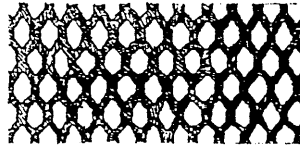


## sheet metal

Metal in thin sheets or plates, used in the manufacture of ductwork, flashing, and roofing.

## corrugated metal

Sheet metal drawn or rolled into parallel ridges and furrows for additional mechanical strength.



## expanded metal

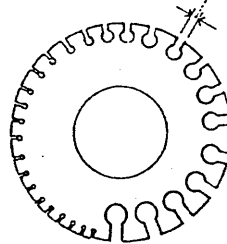
Sheet metal slotted and stretched into a stiff, open mesh or lattice, used esp. as lath.

## blackplate

Cold-rolled sheet steel before pickling or cleaning, used for coating with zinc, tin, or terne metal.

## gauge

Any of various standards for designating the thickness or diameter of a thin object, as the thickness of sheet metal or the diameter of a wire or screw. Also, gage.



## wire gauge

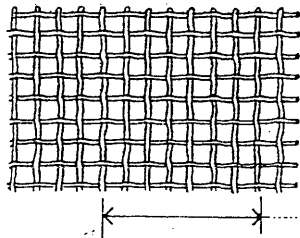
A gauge calibrated for determining the diameter of wire or thickness of sheet metal, consisting of a steel plate with a series of standard-sized notches around the edge.

## wire cloth

A fabric of woven metallic wire, used in screens, sieves, or the like.

## hardware cloth

A galvanized steel wire cloth with a mesh between 0.25 and 0.50 in. (6.4 to 12.7 mm).



## mesh

The number of openings per inch in wire cloth.



## wire rope

A heavy rope made of or containing wire strands twisted around a central core.

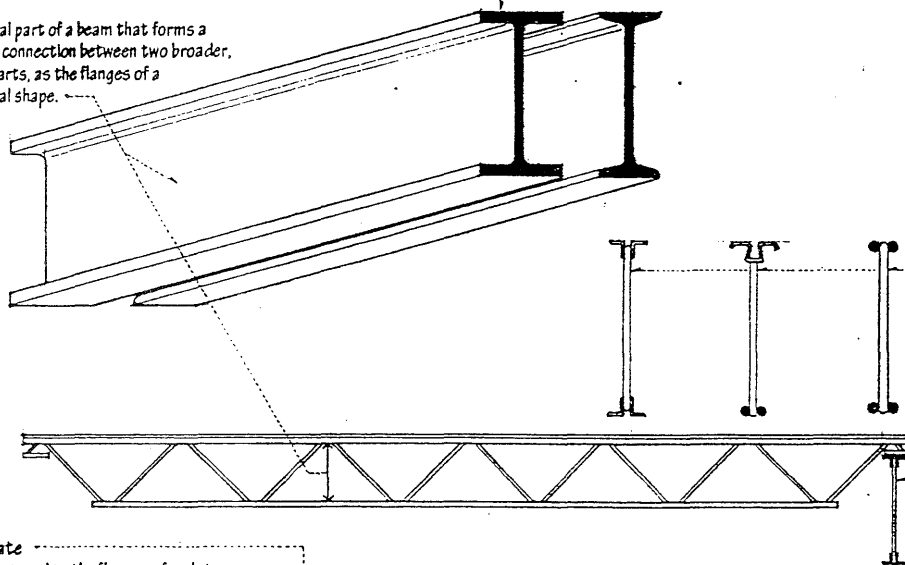
**flange**  
A broad ridge or pair of ridges projecting at a right angle from the edge of a structural shape in order to strengthen or stiffen it.

**web**  
An integral part of a beam that forms a flat, rigid connection between two broader, parallel parts, as the flanges of a structural shape.

**I-beam**  
A rolled or extruded metal beam having a cross section resembling the capital letter I.

**structural steel**  
Steel that is hot-rolled or cold-formed in a variety of standard shapes and fabricated for use as load-bearing members or elements.

**steel beam**  
A beam consisting of a single or built-up structural steel section.



**open-web steel joist**  
A lightweight, fabricated steel joist having an open web. A K-Series joist has a web consisting of a single bent bar, running in a zigzag pattern between the upper and lower chords. LH- and DLH-Series joists have heavier web and chord members for increased loads and spans. Also called bar joist.

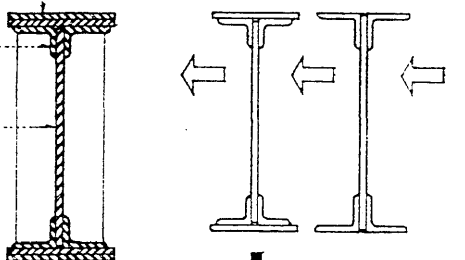
**joist girder**  
A trussed girder for supporting open-web steel joists.

**cover plate**  
A plate fastened to the flanges of a plate girder to increase its section modulus in areas subject to high-bending stresses.

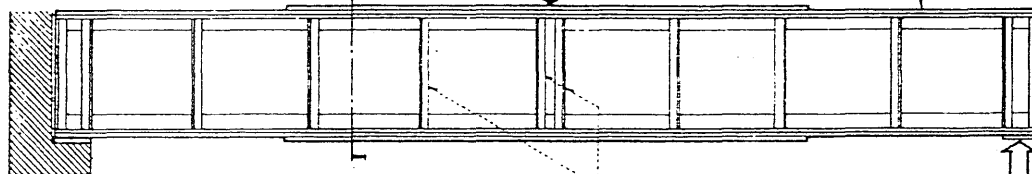
**flange angle**  
One of the angles forming the top or bottom flange of a plate girder.

**web plate**  
A steel plate forming the web of a plate girder.

**shear plate**  
A plate fastened to the web of a plate girder to increase its resistance to shearing stresses.



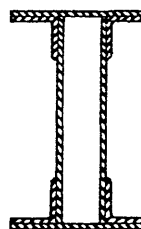
**plate girder**  
A steel girder built up from plates or shapes that are welded or riveted together.



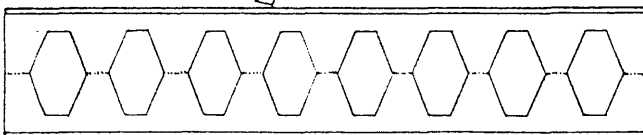
**stiffener**  
One of a pair of vertical angles fastened to each side of a web plate to stiffen it against buckling.

**bearing stiffener**  
A stiffener angle for the web of a plate girder, placed at a point of support or under a concentrated load.

**intermediate stiffener**  
A stiffener angle for the web of a plate girder, placed between bearing stiffeners for increased resistance to diagonal compressive stresses.



**box girder**  
A steel beam built up from shapes and having a hollow, rectangular cross section.



**castellated beam**  
A steel beam fabricated by dividing the web of a wide-flange section with a lengthwise zigzag cut, then welding both halves together at the peaks, thus increasing its depth without increasing its weight.

# MOISTURE PROTECTION

## Joint sealant

Any of various viscous substances injected into a building joint, curing to form a flexible material that adheres to the surrounding surfaces and seals the joint against the passage of air and water.

## Joint movement

The change in width of a building joint resulting from a change in temperature.

## Extensibility

The capacity of a sealant to be extended in tension.

## High-range sealant

A joint sealant of polysulfide, polyurethane, or silicone capable of elongations up to 25%, used for sealing joints in curtain-wall systems.

## Medium-range sealant

A joint sealant of butyl rubber or acrylic capable of elongations up to 10%, used for sealing nonworking or mechanically fastened joints.

## Caulk

A low-range joint sealant used for filling or closing a seam, crevice or crack in order to make it watertight and airtight. Also, caulking.

## Bead

A narrow deposit of sealant applied to a building joint.

## Bond face

The surface of a building component or joint that serves as a substrate for a sealant and to which the sealant is bonded.

## Substrate

Any material that underlies and serves as a base or foundation.

## Primer

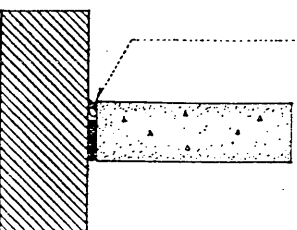
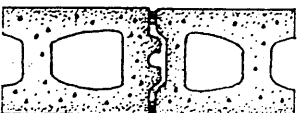
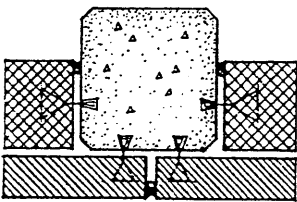
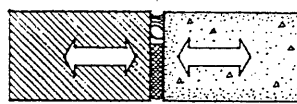
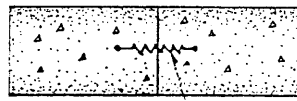
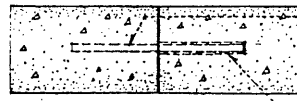
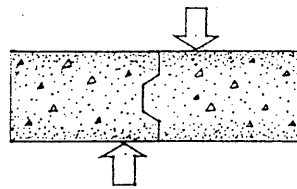
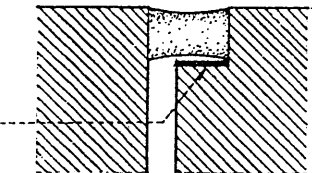
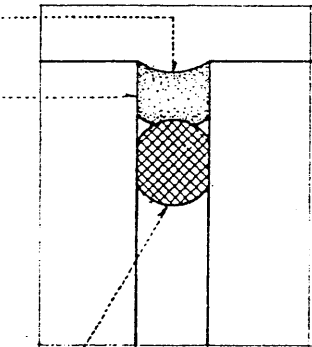
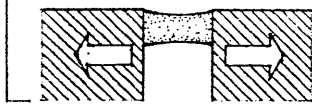
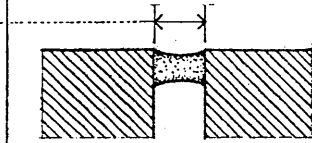
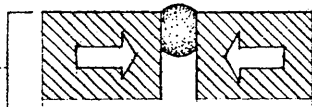
A liquid for improving the adhesion of a sealant to a substrate.

## Joint filler

A compressible strip, rod, or tube of resilient material, as neoprene or butyl, used for filling a joint and controlling the depth of a sealant. Also called backup rod.

## Bond breaker

Any of various materials, as polyethylene tape, used for preventing the adhesion of a sealant to the bottom of a joint.



**construction joint**  
A joint between two successive placements of concrete, often keyed or doweled to provide lateral stability across the joint.

**dowel**  
A short reinforcing bar extending equally into two abutting sections of concrete to prevent differential movement.

**expansion sleeve**  
A pipe sleeve that allows the housed element to move freely in a longitudinal direction.

**waterstop**  
A flexible strip of rubber or plastic inserted across a concrete or masonry joint to prevent the passage of water.

**expansion joint**  
A joint between two parts of a building or structure permitting thermal or moisture expansion to occur without damage to either part. Expansion joints also serve as isolation joints and control joints.

**expansion joint cover**  
A prefabricated cover for protecting an expansion joint while allowing relative movement between the two parts being connected.

**control joint**  
A continuous groove or separation formed, sawed, or tooled in a concrete or masonry structure to form a plane of weakness and thus regulate the location and amount of cracking resulting from drying shrinkage or thermal stresses.

**contraction joint**  
A joint between two parts of a structure, designed to compensate for the contraction of either part.

**isolation joint**  
A joint separating two sections of a structure so that differential movement or settlement can occur between the parts.

Any of five styles of classical architecture characterized by the type and arrangement of columns and entablatures employed, as the Doric, Ionic, Corinthian, Tuscan, and Composite orders.

**cymatium**  
The crowning member of a classical cornice, usually a cyma recta.

**corona**  
The projecting, slablike member of a classical cornice, supported by the bed molding and crowned by the cymatium.

**bed molding**  
The molding or group of moldings immediately beneath the corona of a cornice.

**columniation**  
The use or arrangement of columns in a structure.

**distyle**  
Having two columns on one or each front.

**tristyle**  
Having three columns on one or each front.

**tetastyle**  
Having four columns on one or each front.

**pentastyle**  
Having five columns on one or each front.

**hexastyle**  
Having six columns on one or each front.

**heptastyle**  
Having seven columns on one or each front.

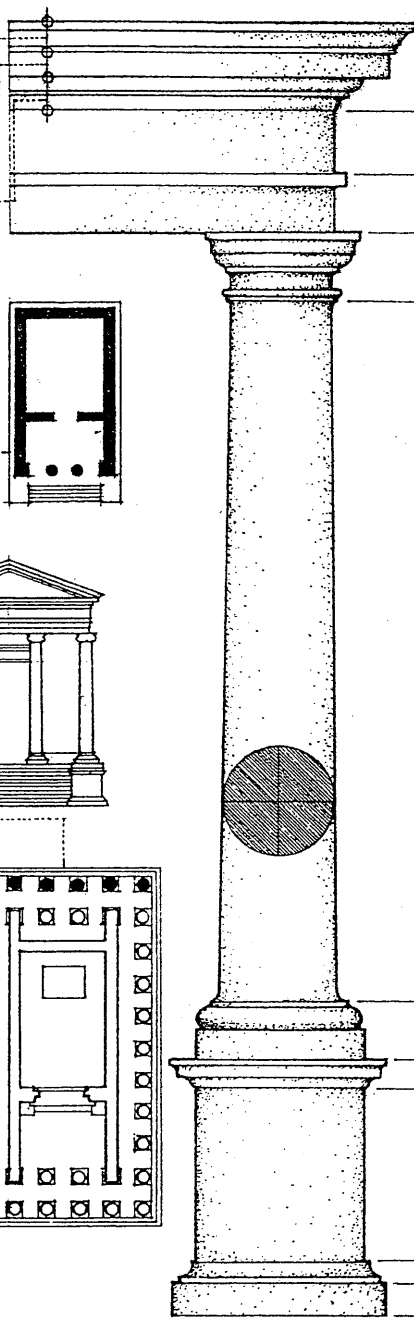
**octastyle**  
Having eight columns on one or either front.

**enneastyle**  
Having nine columns on one or on each front. Also, *enneastylar*.

**decastyle**  
Having 10 columns on one or on each front.

**dodecastyle**  
Having 12 columns on one or either front. Also, *dodecastylar*, *duodecastyle*.

**intercolumniation**  
The space between two adjacent columns, usually the clear space between the lower parts of the shafts, measured in diameters. Also, a system for spacing columns in a colonnade based on this measurement.



**cornice**  
The uppermost member of a classical entablature, consisting typically of a cymatium, corona, and bed molding.

**frieze**  
The horizontal part of a classical entablature between the cornice and architrave, often decorated with sculpture in low relief.

**architrave**  
The lowermost division of a classical entablature, resting directly on the column capitals and supporting the frieze.

**capital**  
The distinctively treated upper end of a column, pillar, or pier, crowning the shaft and taking the weight of the entablature or architrave.

**shaft**  
The central part of a column or pier between the capital and the base.

**base**  
The lowermost portion of a wall, column, pier, or other structure, usually distinctively treated and considered as an architectural unit.

**cornice or cap**

**dado**  
The part of a pedestal between the base and the cornice or cap. Also called *die*.

**base molding**

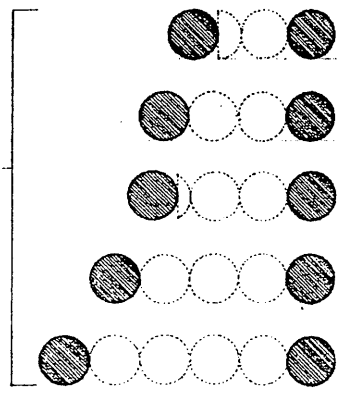
**plinth**  
The usually square slab beneath the base of a column, pier, or pedestal.

**entablature**  
The horizontal section of a classical order that rests on the columns, usually composed of a cornice, frieze, and architrave.

**column**  
A cylindrical support in classical architecture, consisting of a capital, shaft, and usually a base, either monolithic or built up of drums the full diameter of the shaft.

**pedestal**  
A construction upon which a column, statue, memorial shaft, or the like, is elevated, usually consisting of a cornice or cap, a dado, and a base.

*of ac bcd bbb*



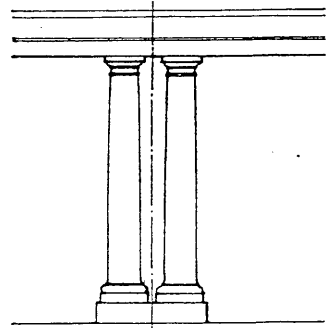
**pycnostyle**  
Having an intercolumniation of 1/2 diameters.

**systyle**  
Having an intercolumniation of two diameters.

**eustyle**  
Having an intercolumniation of 2 1/4 diameters.

**diastyle**  
Having an intercolumniation of three diameters.

**araeostyle**  
Having an intercolumniation of four diameters. Also, *araeostyle*.



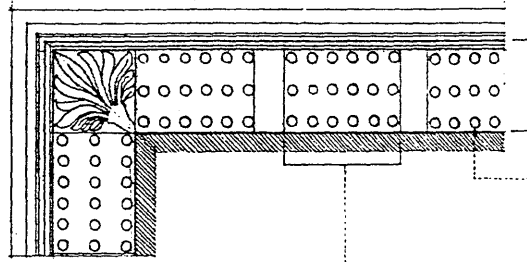
**accouplement**  
The placement of two columns or pilasters very close together.

*pl eda  
1/2 2 1/4 3 4*

# ORDER

## Doric order

The oldest and simplest of the five classical orders, developed in Greece in the 7th century B.C. and later imitated by the Romans, characterized by a fluted column having no base, a plain cushion-shaped capital supporting a square abacus, and an entablature consisting of a plain architrave, a frieze of triglyphs and metopes, and a cornice, the corona of which has mutules on its soffit. In the Roman Doric order, the columns are more slender and usually have bases, the channeling is sometimes altered or omitted, and the capital consists of a bandlike necking, an echinus, and a molded abacus.



**soffit**  
The underside of an architectural element, as an arch, beam, cornice, or staircase.

**gutta**  
One of a series of small, droplike ornaments, attached to the undersides of the mutules and regulae of a Doric entablature. Also called drop.

**mutule**  
A projecting flat block under the corona of a Doric cornice, corresponding to the modillion of other orders.

## triglyph

One of the vertical blocks separating the metopes in a Doric frieze, typically having two vertical grooves or glyphs on its face, and two chamfers or hemiglyphs at the sides.

## metope

Any of the panels, either plain or decorated, between triglyphs in the Doric frieze. Also called intertriglyph.

## taenia

A raised band or fillet separating the frieze from the architrave on a Doric entablature. Also, tenia.

## regula

A fillet beneath the taenia in a Doric entablature, corresponding to a triglyph above and from which guttae are suspended. Also called guttae band.

## abacus

The flat slab forming the top of a column capital, plain in the Doric style, but molded or otherwise enriched in other styles.

## echinus

The prominent circular molding supporting the abacus of a Doric or Tuscan capital.

## necking

The upper part of a column, just above the shaft and below the projecting part of the capital, when differentiated by a molding, groove, or the omission of fluting.

## annulet

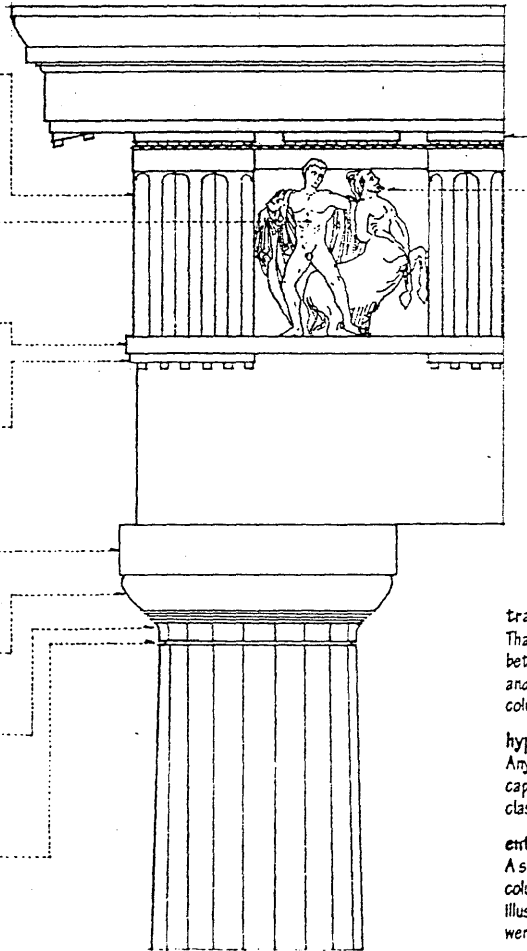
An encircling band, molding, or fillet, on a capital or shaft of a column.

## fluting

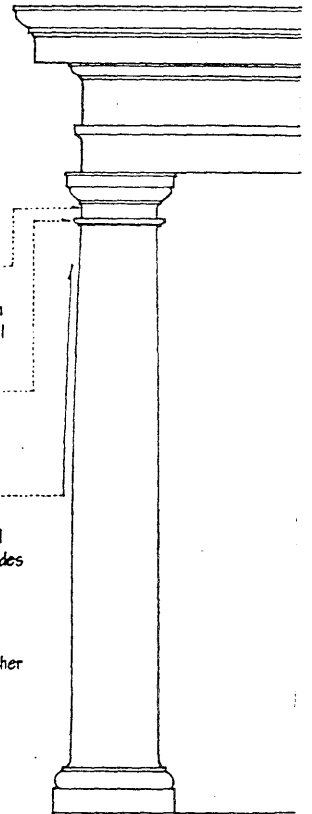
A decorative motif consisting of a series of long, rounded, parallel grooves, as on the shaft of a classical column.

## flute

A rounded channel or groove. Also called stria.



**zophorus**  
A frieze bearing carved figures of people or animals. Also, zoophorus.



**trachelium**  
That part of the necking between the hypotrachelium and the capital of a classical column.

**hypotrachelium**  
Any member between the capital and the shaft of a classical column.

**entasis**  
A slight convexity given to a column to correct an optical illusion of concavity if the sides were straight.

**drum**  
Any of several cylindrical stones laid one above the other to form a column or pier.

## Tuscan order

A classical order of Roman origin, basically a simplified Roman Doric characterized by an unfluted column and a plain base, capital, and entablature having no decoration other than moldings.



**egg and dart**  
An ornamental motif for enriching an ovolo or echinus, consisting of a closely set, alternating series of oval and pointed forms. Also called egg and tongue.

**dentil**  
Any of a series of closely spaced, small, rectangular blocks forming a molding or projecting beneath the coronas of Ionic, Corinthian, and Composite cornices.

**fascia**  
One of the three horizontal bands making up the architrave in the Ionic order.

**Attic base**  
A base to a classical column, consisting of an upper and a lower torus separated by a scotia between two fillets.

**scotia**  
A deep concave molding between two fillets. Also called trochilus.

**torus**  
A large convex, semicircular molding, commonly found directly above the plinth of the base of a classical column.

**Ionic order**  
A classical order that developed in the Greek colonies of Asia Minor in the 6th century B.C., characterized esp. by the spiral volutes of its capital. The fluted columns typically had molded bases and supported an entablature consisting of an architrave of three fascias, a richly ornamented frieze, and a cornice corbeled out on egg-and-dart and dentil moldings. Roman and Renaissance examples are often more elaborate, and usually set the volutes of the capitals 45° to the architrave.

**volute**  
A spiral, scroll-like ornament, as on the capitals of the Ionic, Corinthian, and Composite orders.

**cathetus**  
The vertical guideline through the eye of a volute in an Ionic capital, from which the spiral form is determined.

**echinus**  
The circular molding under the cushion of an Ionic capital between the volutes, usually carved with an egg-and-dart pattern. Also called cymatium.

**fillet**  
A narrow part of the surface of a column left between adjoining flutes.

**apophyge**  
A small, concave curve joining the shaft of a classical column to its base. Also called apophysis.

**modillion**  
An ornamental bracket, usually in the form of a scroll with acanthus, used in series beneath the corona of a Corinthian, Composite, or Roman Ionic cornice.

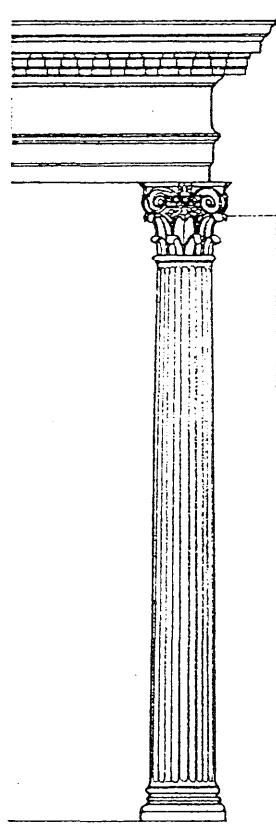
**helix**  
A spiral ornament, as any of the volutes issuing from a cauliculus in a Corinthian capital.

**cauliculus**  
Any of the ornamental stalks rising between the acanthus leaves of a Corinthian capital, from which the volutes spring. Also called caulcole.

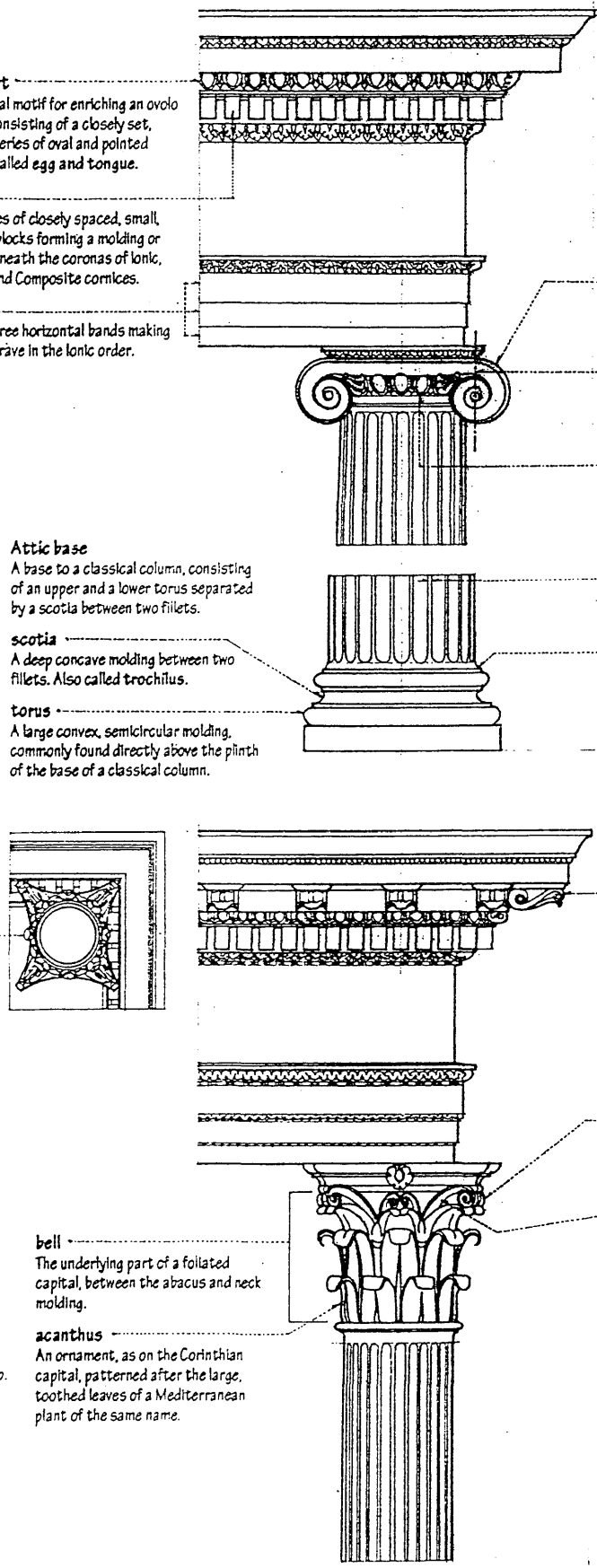
**bell**  
The underlying part of a foliated capital, between the abacus and neck molding.

**acanthus**  
An ornament, as on the Corinthian capital, patterned after the large, toothed leaves of a Mediterranean plant of the same name.

**Corinthian order**  
The most ornate of the five classical orders, developed by the Greeks in the 4th century B.C. but used more extensively in Roman architecture, similar in most respects to the Ionic but usually of slenderer proportions and characterized esp. by a deep bell-shaped capital decorated with acanthus leaves and an abacus with concave sides.



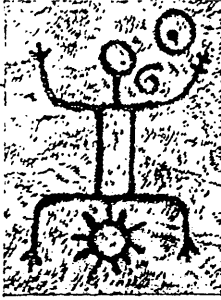
**Composite order**  
One of the five classical orders, popular esp. since the beginning of the Renaissance but invented by the ancient Romans, in which the Corinthian order is modified by superimposing four diagonally set Ionic volutes on a bell of Corinthian acanthus leaves.



# ORNAMENT

An accessory, article, or detail that lends grace or beauty to something to which it is added or of which it is an integral part.

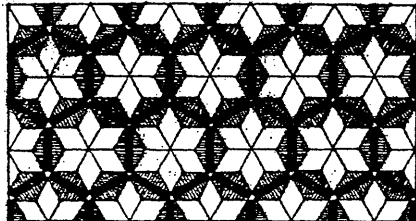
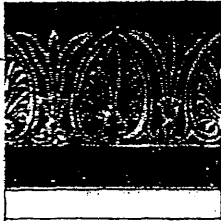
**pictograph**  
A pictorial sign or symbol.



**graffito**  
An ancient drawing or writing scratched on stone, plaster, or other hard surface.

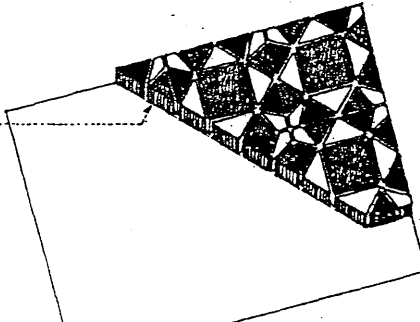


**graffiti**  
Inscriptions or drawings spray-painted or sketched on a public surface, as a sidewalk or wall of a building.

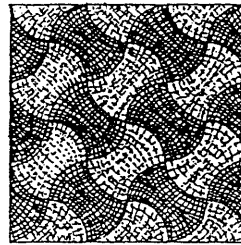


**sgraffito**  
Decoration produced by cutting or scratching through a surface layer of paint or plaster to reveal a ground of contrasting color.

**mosaic**  
A picture or decorative pattern made by inlaying small, usually colored pieces of tile, enamel, or glass in mortar.



**tessera**  
One of the small pieces of colored marble, glass, or tile used in mosaic work.

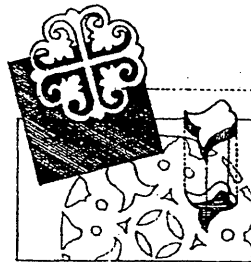


**smalto**  
Colored glass or enamel, esp. in the form of minute squares, used in mosaic work.

**relief**  
The projection of a figure or form from the flat background on which it is formed.



**cavo-relievo**  
Sculptural relief in which the highest points of the modeled forms are below or level with the original surface. Also called sunk relief.



**alto-relievo**  
Sculptural relief in which the modeled forms project from the background by at least half their depth. Also called high relief.

**mezzo-relievo**  
Sculptural relief intermediate between high relief and bas-relief. Also called demirelief, half relief.



**bas-relief**  
Sculptural relief that projects very slightly from the background. Also called basso-relievo, low relief.

**anaglyph**  
An ornament carved or embossed in low relief.

**mural**  
A large picture painted on or applied directly to a wall or ceiling surface.

**fresco**  
The art or technique of painting on a freshly spread, moist plaster surface with pigments ground up in water or a limewater mixture. Also, a picture or design so painted.

**opus sectile**  
Any mosaic of regularly cut material.

**opus Alexandrinum**  
A form of opus sectile having a geometric pattern formed with few colors, as black and white, or dark green and red.

**opus vermiculatum**  
A mosaic of tessera arranged in wavy lines resembling the form or tracks of a worm.

**Florentine mosaic**  
A mosaic made by inlaying fine, delicately colored stones into a white or black marble surface.

**appliqué**  
A decoration or ornament made by cutting out a design and fastening it to a larger piece of material.

**inlay**  
To decorate by setting pieces of wood, ivory, or the like into a surface, usually at the same level.

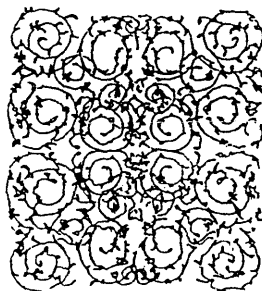
**emboss**  
To raise, mold, or carve a surface design in relief.

**engrave**  
To carve, cut, or etch designs on a hard surface, as of metal, stone, or the end grain of wood.

**intaglio**  
A figure or design incised into the surface of a stone or metal plate so that an impression yields a figure in relief.

**openwork**  
Ornamental or structural work having a latticelike nature or showing openings through its substance.

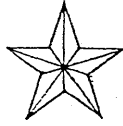
**filigree**  
Ornamental openwork of delicate or intricate design. Also, filagree.



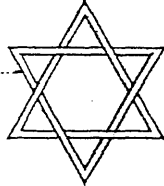
**pastiche**  
An artistic composition consisting of forms or motifs borrowed from different sources.

**postiche**  
Artificial counterfeit, or false, as an architectural ornament that is added superfluously or inappropriately.

**star**  
A conventional figure usually having five or more points radiating from a center, often used as an ornament and symbol.



**Star of David**  
A hexagram used as a symbol of Judaism. Also called Magen David, Mogen David.



**hexagram**  
A six-pointed starlike figure, formed by extending each of the sides of a regular hexagon into equilateral triangles.

**glory**  
A ring, circle, or surrounding radiance of light, as a halo, nimbus, or aureole.



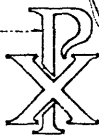
**halo**  
A disk or ring of radiant light around or above the head, traditionally symbolizing the sanctity of a divine or sacred personage in religious paintings and sculptures. Also called nimbus.

**aureole**  
A circle of light or radiance surrounding the head or body in the representation of a sacred personage.

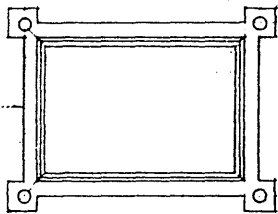
**vesica piscis**  
An elliptical, pointed figure used esp. in early Christian art as an emblem of Christ. Also called mandorla.



**Chi-Rho**  
A Christian monogram and symbol formed by superimposing the first two letters of the Greek word for Christ. Also called *chrismon*.

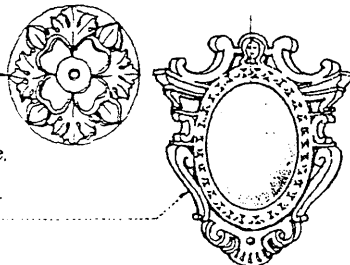


**table**  
A raised or sunken rectangular panel on a wall, distinctively treated or ornamented with inscriptions, painting, or sculpture.



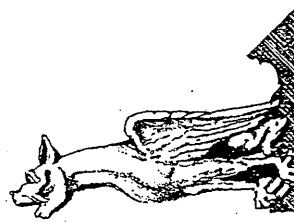
**tablet**  
A flat slab or plaque having a surface suitable for or bearing an inscription, carving, or the like.

**medallion**  
A usually oval or circular tablet, often bearing a figure or ornament in relief.



**cartouche**  
An oval or oblong, slightly convex surface, usually surrounded with ornamental scrollwork, for receiving a painted or low-relief decoration. Also, cartouch.

**grotesque**  
A decorative style characterized by the fantastic shaping and combining of incongruous human and animal forms with foliage or similar figures, often distorting the natural into caricature or absurdity.



**antic**  
A grotesque sculpture of animal, human, or foliated forms, as a gargoyle.

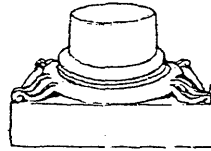
**mask**  
An often grotesque representation of a head or face, used as an architectural ornament. Also called *mascaron*.



**griffin**  
A mythological animal typically having the head and wings of an eagle and the body and tail of a lion. Also, *griffon*, *gryphon*.



**griffe**  
An ornament projecting from the round base of a column toward a corner of a square or polygonal plinth. Also called *spur*.

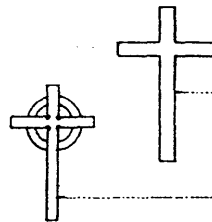


**ballflower**  
A medieval English ornament suggesting a flower of three or four petals enclosing and partially concealing a ball.



**cross**  
An object or figure consisting essentially of an upright and a transverse piece at right angles to each another, often used as a symbol of Christianity.

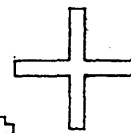
**Latin cross**  
A cross having an upright or vertical shaft crossed near the top by a shorter horizontal bar.



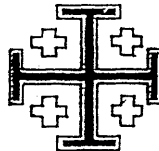
**Celtic cross**  
A cross shaped like a Latin cross and having a ring about the intersection of the shaft and crossbar.



**Greek cross**  
A cross consisting of an upright crossed in the middle by a horizontal of the same length.



**Jerusalem cross**  
A cross whose four arms each terminate in a crossbar, often with a small Greek cross centered in each quadrant.



**Maltese cross**  
A cross formed having the outer face of each arm indented in a V.



**cross formée**  
A cross having arms of equal length, each expanding outward from the center.

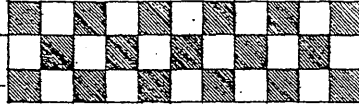
# ORNAMENT

**motif**

A distinctive and recurring shape, form, or color in a design.

**checker**

To mark or decorate with a squared pattern.



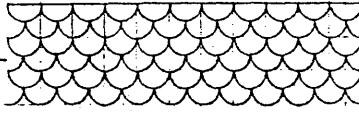
**reticulate**

Resembling or covered with a network of regularly intersecting lines.



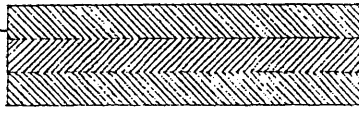
**diaper**

A pattern of small, repeated figures connecting or growing out of one another, originally used in the Middle Ages in weaving silk and gold.



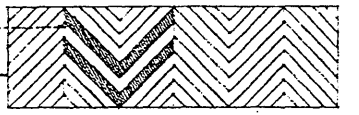
**imbrication**

A pattern or design resembling the regular overlapping of tiles or shingles.



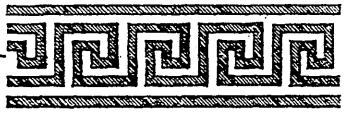
**herringbone**

A pattern consisting of rows of short, parallel lines which in any two adjacent rows slant in opposite directions, used in masonry, parquetry, and weaving.



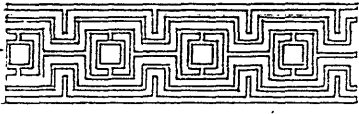
**chevron**

A V-shaped pattern used in heraldry and as ornamentation.



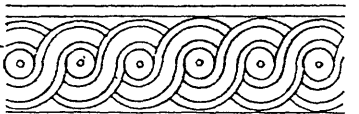
**dancette**

An ornamental zigzag, as in a molding.



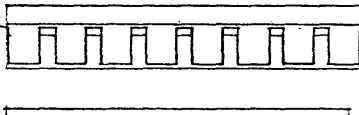
**fret**

A decorative design contained within a band or border, consisting of repeated, often geometric figures. Also called key pattern.



**meander**

A running ornament consisting of an intricate variety of fret or fretwork.



**guilloche**

An ornamental border formed of two or more interlaced bands around a series of circular voids.



**dentil band**

A molding occupying the position of a row of dentils, and often carved to resemble one.



**Yenetlan dentil**

Any of a series of small rectangular blocks alternating with sloping surfaces on an archivolot or molding.



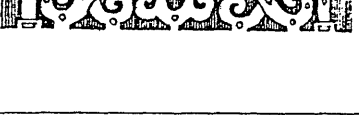
**scroll**

An ornament having a spiral or convoluted form resembling a partly or loosely rolled parchment.



**Vitruvian scroll**

A series of scrolls forming a stylized wave pattern. Also called Vitruvian wave, wave scroll.



**banderole**

A sculptured band resembling a long ribbon or scroll, adapted to receive an inscription. Also, banderol, bandrole.



**strapwork**

Ornamentation composed of folded, crossed, and interlaced bands, sometimes cut with foliations.

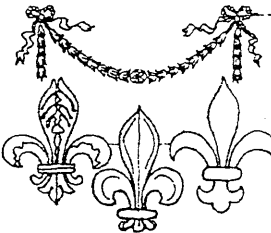


**foliated**

Ornamented with foils or representations of foliage. Also, foliate.

**wreath**

A decorative band or garland of flowers, foliage, or other ornamental material.

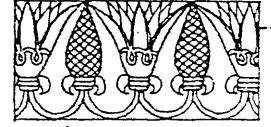


**festoon**

A decorative representation of a string or garland of flowers, foliage, ribbon, or the like, suspended in a curve between two points.

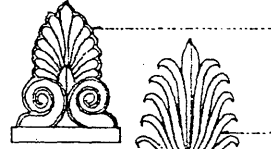
**fleur-de-lis**

A stylized three-petaled iris flower tied by an encircling band, used as the heraldic bearing of the royal family of France. Also, fleur-de-tys.



**lotus**

A representation of various aquatic plants in the water lily family, used as a decorative motif in ancient Egyptian and Hindu art and architecture.



**anthemion**

An ornament of honeysuckle or palm leaves in a radiating cluster. Also called honeysuckle ornament.



**palmette**

A stylized palm leaf shape used as a decorative element in classical art and architecture.



**rosette**

An ornament having a generally circular combination of parts resembling a flower or plant. Also, rose.



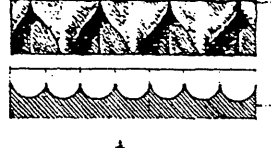
**dogtooth**

Any of a series of closely spaced, pyramidal ornaments, formed by sculptured leaves radiating from a raised center, used esp. in early English Gothic architecture.



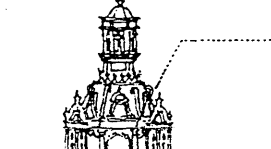
**arabesque**

A complex and ornate design that employs flowers, foliage, and sometimes animal and geometric figures to produce an intricate pattern of interlaced lines.



**calf's-tongue**

A molding having pendant, tongue-like elements carved in relief against a flat or curved surface.



**scallop**

Any of a series of curved projections forming an ornamental border.



**purfle**

To decorate a shrine or tabernacle with miniature architectural forms so as to produce a lay effect.

**arris**  
A sharp edge or ridge formed by two surfaces meeting at an exterior angle. Also called *piend*.

**bullnose**  
A rounded or obtuse exterior angle. Also, *bull's-nose*.

**splay**  
A surface that makes an oblique angle with another.

**fillet**  
A narrow flat molding or area, raised or sunk to separate larger moldings or areas. Also called *list*.

**billet**  
Any of a series of closely spaced cylindrical forms ornamenting a hollow molding or cornice.

**cove**  
A concave surface or molding, esp. at the transition from wall to ceiling.

**cavetto**  
A concave molding having an outline that approximates a quarter circle.

**congé**  
A concave molding having the form of a quadrant curving away from a given surface and terminating perpendicular to a fillet parallel to that surface. Also, *congee*.

**ogee**  
A molding having a profile of a double curve in the shape of an elongated S. Also called *gula*.

**cyma**  
A projecting molding having the profile of a double curve formed by the union of a convex line and a concave line.

**cyma recta**  
A cyma having the concave part projecting beyond the convex part. Also called *Doric cyma*.

**cyma reversa**  
A cyma having the convex part projecting beyond the concave part. Also called *Lesbian cyma*.

**beak**  
A small pendant molding forming a drip and casting a deep shadow, as on the soffit of a cornice. Also called *bird's beak*.

**brace molding**  
A projecting molding having a profile formed by two ogees symmetrically disposed about an arris or fillet. Also called *keel*.

**profile**  
An outline of an object formed on a vertical plane passed through the object at right angles to one of its principal horizontal dimensions.

**molding**  
Any of various long, narrow, ornamental surfaces with uniform cross sections and a profile shaped to produce modulations of light, shade, and shadow. Almost all moldings derive at least in part from wood prototypes, as those in classical architecture, or stone prototypes, as those in Gothic architecture. By extension, the term now refers to a slender strip of wood or other material having such a surface and used for ornamentation and finishing. Also, *mold*, *moulding*.

**half round**  
A molding having a semicircular cross section.

**quarter round**  
A convex molding whose section is a quarter circle.

**ovolo**  
A convex molding having a profile approximating a quarter section of a circle or ellipse.

**bollet**  
A convex, rounded molding. Also, *boutel*, *bowtel*.

**gadroon**  
A convex molding elaborately carved with reeding or indented with notches. Also, *godroon*.

**Aaron's rod**  
A convex molding having pointed leaves or scrollwork emerging at regular intervals.

**cable molding**  
A convex molding having the form of a rope.

**bead**  
A small convex molding usually having a continuous cylindrical surface.

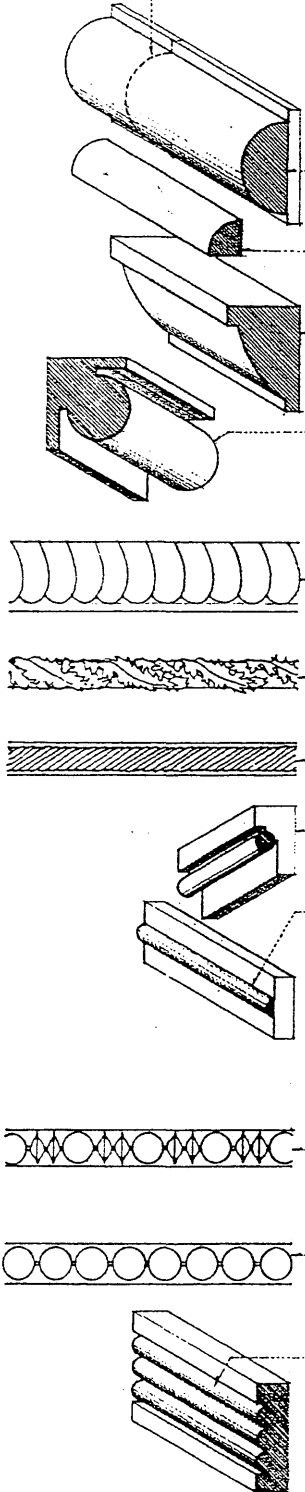
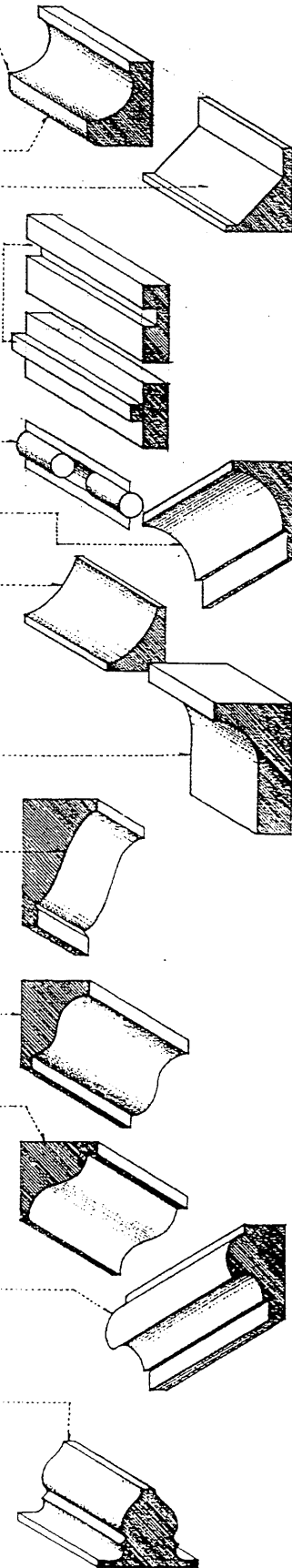
**astragal**  
A small convex molding usually semicircular in section.

**baguette**  
A small convex molding of semicircular section, smaller than an astragal. Also, *baguet*.

**bead and reel**  
A convex molding having the form of disks alternating with spherical or elongated beads.

**pearl molding**  
A molding having the form of a row of pearls or beads. Also called *bead molding*, *Paternoster*.

**reeding**  
A parallel set of small convex moldings for ornamenting a plane or curved surface.



# ORNAMENT

**trim**  
The finished woodwork or the like used to decorate, border, or protect the edges of openings or surfaces.

**cornice**  
A continuous, molded projection that crowns a wall or other construction, or divides it horizontally for compositional purposes.

**picture mold**  
A horizontal molding near a ceiling from which pictures can be suspended. Also called picture rail.

**plate rail**  
A rail or narrow shelf fixed along a wall and grooved to hold plates, esp. for ornament or display.

**chair rail**  
A horizontal molding on an interior wall for preventing the backs of chairs from rubbing against and damaging the wall surface.

**base molding**  
An ornamental molding above the plinth of a pedestal, pillar, or wall.

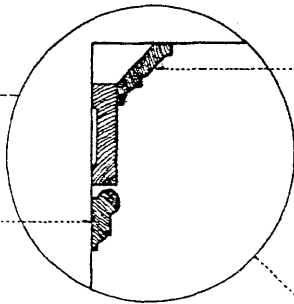
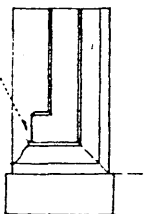
**baseboard**  
A board or molding concealing the joint between an interior wall and the floor. Also called mopboard, skirt.

**shoe**  
A small molding, as a quarter round, covering the joint between a baseboard and the floor. Also called base shoe.

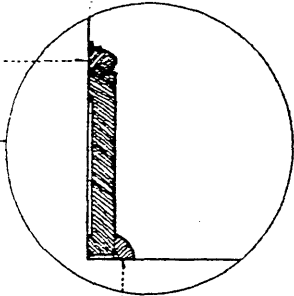
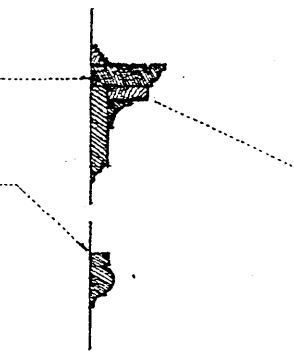
**broken pediment**  
A pediment having its raking cornices interrupted at the crown or apex, the gap often being filled with an urn, a cartouche, or other ornament.

**architrave**  
A molded or decorative band framing a rectangular door or window opening.

**return**  
The continuation of a molding, projection, or other part at an angle, usually 90°, to the main part.



**crown molding**  
Any ornamental molding terminating the top of a structure or decorative feature.

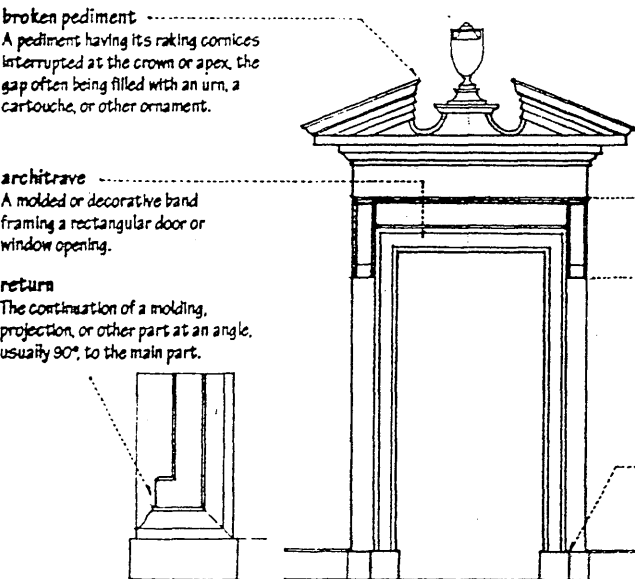
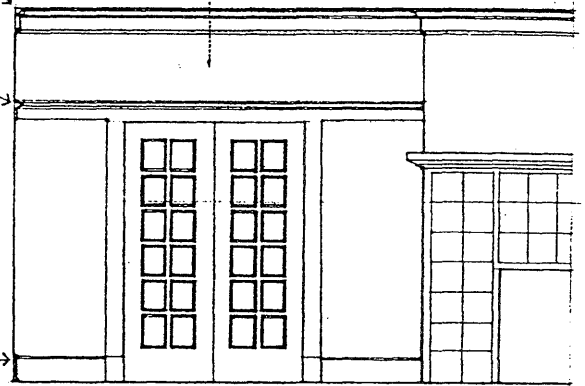


**plint**  
To attach or fasten a molding to a surface.

**kerfing**  
Making a series of parallel saw cuts partway through the thickness of a piece of wood to enable the piece to bend toward the kerfed side.



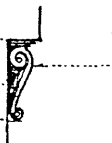
**frieze**  
A decorative band, as one along the top of an interior wall, immediately below the cornice, or a sculptured one in a stringcourse on an outside wall.



**tabernacle frame**  
A frame around a doorway or niche, having two columns or pilasters on a base supporting a pediment.

**ancon**  
A bracket or console used in classical architecture to support a cornice or the entablature over a doorway or window.

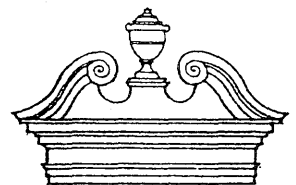
**console**  
An ornamental bracket, usually formed with scrolls and higher than its projection.



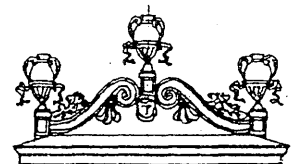
**stop**  
A feature terminating a molding or chamfer.

**plinth block**  
A plinth for stopping the architrave of a door or window above the floor.

**plinth**  
A flat, plain member at the bottom of an architrave, dado, or baseboard.



**swan's neck pediment**  
A broken pediment having an outline formed by a pair of S-curves tangent to the horizontal cornice at the ends of the pediment and rising to a pair of scrolls on either side of the center, where a finial often rises between the scrolls.



**coronet**  
A pedimental ornament wrought in relief over a window or door.

**gloss**  
The degree of surface luster of a dried paint film, ranging in decreasing order of gloss from high gloss, semigloss, eggshell, to flat.

**high gloss**  
Having a brilliant sheen or luster.

**enamel**  
Any paint or varnish drying to a very smooth, hard, usually glossy finish.

**semigloss**  
Having a moderate, satiny luster, producing a finish midway between high gloss and eggshell. Also called satin finish.

**eggshell**  
Having little or no gloss, producing a finish midway between semigloss and flat.

**flat**  
Without gloss or sheen.

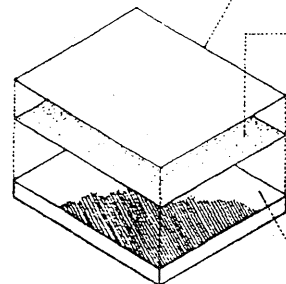
**colorfast**  
Having color that will not fade or run with washing, age, or exposure to light, esp. sunlight.

**actinic ray**  
A ray of light, as ultraviolet, that produces photochemical effects, as the yellowing, chalking, and disintegration of paint coatings.

**photochemical**  
Of or pertaining to the chemical action of radiant energy, esp. light.

**coverage**  
A measure of the area over which a gallon of paint may be spread at a given thickness, usually expressed in square feet per gallon.

**hiding power**  
The ability of a paint film to conceal any marks, pattern, or color on the surface to which it is applied. Also called covering power.



**anticorrosive paint**  
A paint or primer specially formulated with rust-inhibiting pigments to prevent or reduce the corrosion of metal surfaces. Also called rust-inhibiting paint.

**fire-retardant paint**  
A paint specially formulated with silicone, polyvinyl chloride, or other substance to reduce the flame-spread of a combustible material.

**heat-resistant paint**  
A paint specially formulated with silicone resins to withstand high temperatures.

**binder**  
The nonvolatile part of a paint vehicle that bonds particles of pigment into a cohesive film during the drying process.

**solvent**  
The volatile part of a paint vehicle that evaporates during the drying process.

**thinner**  
A volatile liquid used to dilute paint or varnish to the desired or proper consistency for ease in application.

**mineral spirits**  
A volatile distillation of petroleum, used as a solvent and thinner for paints and varnishes.

**turpentine**  
A colorless, volatile oil obtained by distilling oleoresin from various conifers and used as a thinner and solvent for paints and varnishes. Also called oil of turpentine, spirits of turpentine.

**paint system**  
A combination of one or more coatings selected for compatibility with each other and the surface to which they are applied, as well as suitability for the expected exposure and desired decorative effect.

**glaze coat**  
A thin coat of transparent color applied to enhance the color of a painted surface.

**mistcoat**  
A thin, sometimes pigmented coat applied to a finish coat to improve its luster.

**topcoat**  
The final coat of paint applied to a surface. Also called finish coat.

**undercoat**  
A primer or intermediate coat applied to hide the color of the substrate and improve adhesion of the topcoat.

**ground coat**  
A primer or basecoat of paint intended to show through a topcoat. Also called ground color.

**basecoat**  
A first coat of paint or other liquid finish applied to a surface.

**primer**  
A basecoat applied to a surface to improve the adhesion of subsequent coats of paint or varnish. Also called prime coat.

**sealer**  
A basecoat applied to a surface to reduce the absorption of subsequent coats of paint or varnish, or to prevent bleeding through the finish coat.

**pigment**  
A finely ground, insoluble substance suspended in a liquid vehicle to impart color and opacity to a paint.

**vehicle**  
A liquid in which pigment is dispersed before being applied to a surface, to control consistency, adhesion, gloss, and durability.

A mixture of a solid pigment suspended in a liquid vehicle, applied as a thin, usually opaque coating to a surface for protection and decoration.

**drying oil**  
Any of various oil, organic liquids, as linseed oil, that oxidizes and hardens to form a tough elastic film when exposed in a thin layer to air.

**alkyd resin**  
Any of a group of synthetic resins derived from a polyvalent alcohol in reaction with an organic acid, used chiefly in adhesives and paints.

**latex**  
A water emulsion of synthetic rubber or plastic globules obtained by polymerization and used in paints and adhesives.

**dye**  
A soluble coloring material that imparts color by absorption.

**water stain**  
A penetrating stain made by dissolving dye in a water vehicle.

**spirit stain**  
A penetrating stain made by dissolving dye in an alcohol or spirit vehicle.

**oil stain**  
A stain made by dissolving dye or suspending pigment in a drying oil or oil varnish vehicle.

**copal**  
A hard, lustrous resin obtained from various tropical trees, used chiefly in making varnishes.

**spar varnish**  
A durable, weather-resistant varnish made from durable resins and linseed or tung oil. Also called marine varnish.

**polyurethane varnish**  
An exceptionally hard, abrasion-resistant, and chemical-resistant varnish made from a plastic resin of the same name.

**lac**  
A resinous secretion of the female of the lac insect, used in making shellac.

**Chinese lacquer**  
A natural varnish obtained from an Asian sumac, used to produce a highly polished, lustrous surface on wood. Also called Japanese lacquer.

**oil paint**  
A paint in which the vehicle is a drying oil.

**alkyd paint**  
A paint in which the vehicle is an alkyd resin.

**epoxy paint**  
A paint having an epoxy resin as a binder for increased resistance to abrasion, corrosion, and chemicals.

**latex paint**  
A paint having a latex binder that coalesces as water evaporates from the emulsion. Also called rubber-base paint, water-base paint.

**stain**  
A solution of dye or suspension of pigment in a vehicle, applied to penetrate and color a wood surface without obscuring the grain.

**penetrating stain**  
A stain that penetrates a wood surface, leaving a very thin film on the surface.

**pigmented stain**  
An oil stain containing pigments capable of obscuring the grain and texture of a wood surface. Also called opaque stain.

**varnish**  
A liquid preparation consisting of a resin dissolved in an oil (oil varnish) or in alcohol (spirit varnish), that when spread and allowed to dry forms a hard, lustrous, usually transparent coating.

**shellac**  
A spirit varnish made by dissolving purified lac flakes in denatured alcohol. Also called shellac varnish.

**lacquer**  
Any of various clear or colored synthetic coatings consisting of nitrocellulose or other cellulose derivative dissolved in a solvent that dries by evaporation to form a high-gloss film.

# PLASTER

A composition of gypsum or lime, water, sand, and sometimes hair or other fiber, applied in a pasty form to the surfaces of walls or ceilings in a plastic state and allowed to harden and dry.

**gypsum plaster**  
A basecoat plaster made of calcined gypsum mixed with sand, water, and various additives to control its setting and working qualities.

**calcined gypsum**  
Gypsum heated to drive off most of its chemically combined water.

**plaster of Paris**  
Calcined gypsum in white, powdery form, containing no additives to control the set, used as a base for gypsum plaster, as an additive in lime plaster, and as a material for making ornamental casts.

**gypsum**  
A soft mineral, hydrated calcium sulfate, used as a retarder in portland cement and in the making of gypsum plaster.

**alabaster**  
A finely granular form of pure gypsum, often white and translucent, used for ornamental objects and work.

**lime plaster**  
A mixture of lime, sand, and sometimes a fiber, used as a basecoat plaster.

**cement temper**  
The addition of portland cement to lime plaster to improve its strength and durability.

**three-coat plaster**  
Plasterwork applied in three successive coats, a scratch coat followed by a brown coat and a finish coat.

**two-coat plaster**  
Plasterwork applied in two coats, a basecoat followed by a finish coat.

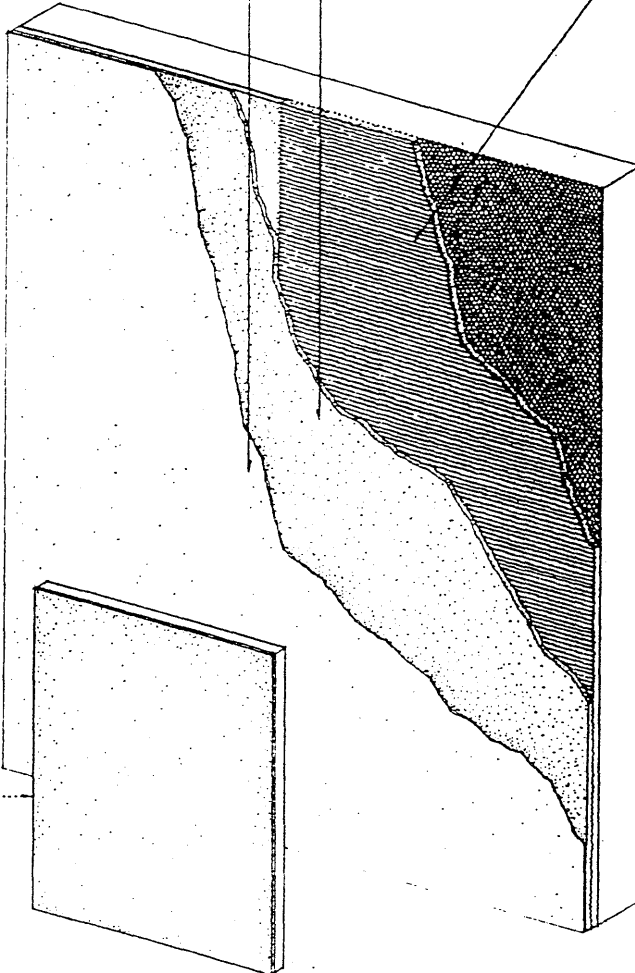
**finish coat**  
The final coat of plaster, serving either as a finished surface or as a base for decoration.

**skim coat**  
A thin leveling or finish coat of plaster.

**brown coat**  
A roughly finished, leveling coat of plaster, either the second coat in three-coat plaster or the base coat in two-coat plaster applied over gypsum lath or masonry. Also called floating coat.

**basecoat**  
Any plaster coat applied before the finish coat.

**scratch coat**  
The first coat in three-coat plaster, which is scratched to provide a better bond for the second or brown coat.



**gauged plaster**  
A finish coat in plastering, consisting of lime putty to which gauging plaster is added to control the setting time and counteract shrinkage.

**gauging plaster**  
A specially ground gypsum plaster for mixing with lime putty, formulated to provide either a quick-set or a slow-set for a finish coat of plaster.

**hard finish**  
A finish coat of lime putty and Keene's cement or gauging plaster, troweled to a smooth, dense finish.

**lime putty**  
Quicklime slaked with sufficient water to form a thick paste. Also called plasterer's putty.

**Keene's cement**  
Trademark for a brand of white anhydrous gypsum plaster that produces an exceptionally strong, dense, crack-resistant finish.

**anhydrous**  
Having all water of crystallization removed.

**white coat**  
A finish coat of lime putty and white gauging plaster, troweled to a smooth, dense finish.

**veneer plaster**  
A ready-mixed gypsum plaster applied as a very thin, one- or two-coat finish over a veneer base. Also called thin-coat plaster.

**acoustical plaster**  
A low-density plaster containing vermiculite or other porous material to enhance its ability to absorb sound.

**hardwall**  
A basecoat of neat gypsum plaster.

**neat plaster**  
A gypsum basecoat plaster having no admixture except hair or other fiber, used for on-the-job mixing with aggregates.

**wood-fibered plaster**  
A mill-mixed gypsum basecoat plaster containing coarse cellulose fibers for greater bulk, strength, and fire resistance, used neat or mixed with sand to obtain a basecoat of superior hardness.

**bond plaster**  
A gypsum basecoat plaster containing a small amount of lime and chemical additives to improve the bond of succeeding coats to dense, nonporous surfaces.

**gypsum-perlite plaster**  
A gypsum basecoat plaster containing perlite as an aggregate to reduce its weight and increase its thermal and fire resistance.

**gypsum-vermiculite plaster**  
A gypsum basecoat plaster containing vermiculite as an aggregate to reduce its weight and increase its thermal and fire resistance.

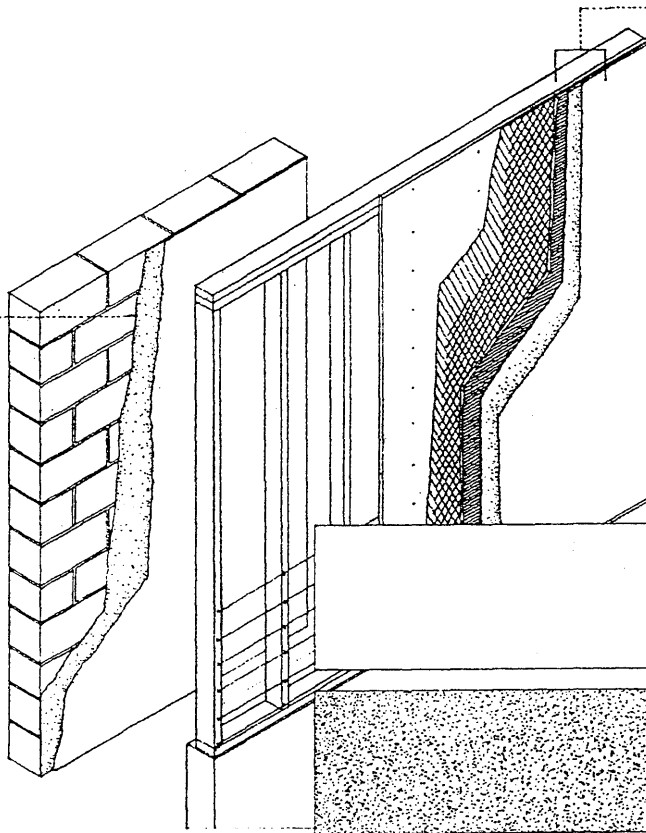
**ready-mixed plaster**  
Plaster that is formulated and dry-mixed by the manufacturer, requiring only the addition of water at the job site.



**rendering coat**  
The first coat of plaster on a masonry wall. Also called rough coat.

**spatter dash**  
A wet, rich mix of portland cement and sand thrown onto a smooth brick or concrete surface and allowed to harden to provide a key for a first coat of plaster.

**key**  
A grooving or roughness applied to a surface to improve its bond with another surface.



**stucco**

A coarse plaster composed of portland or masonry cement, sand, and hydrated lime, mixed with water and applied in a plastic state to form a hard covering for exterior walls.

**portland cement stucco**

Stucco made with masonry cement or with portland cement mixed with less than 50% by volume of lime.

**portland cement-lime stucco**

Portland cement stucco to which lime is added in an amount greater than 50% by volume to improve the plasticity of the mix.

**albarium**

A stucco used in ancient times, made from powdered marble and lime mortar and often polished.

**intonaco**

A finish coat of plaster made with white marble dust to receive a fresco.

**scagliola**

Plasterwork imitating granite or marble.

**sand-float finish**

A textured finish coat of plaster containing sand, leveled and smoothed with a float.

**float finish**

A fine-textured stucco finish produced by smoothing with a carpet or rubber-faced float.

**combed finish**

A stucco finish produced by dragging a serrated tool across the stucco surface before it sets. Also called dragged finish.

**dash-troweled finish**

A stucco finish produced by troweling the high spots of a dashed stucco surface before it sets.

**stipple-troweled finish**

A stucco finish produced by troweling the high spots of a stippled stucco surface before it sets.

**daubing**

The process of giving a wall a rough finish by throwing plaster against it.

**pebble dash**

An exterior wall finish produced by throwing and pressing small pebbles into unset stucco.

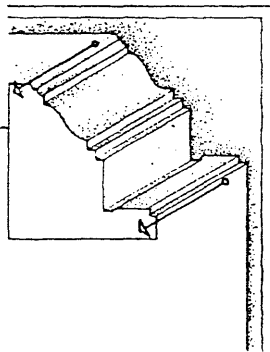
**roughcast**

An exterior wall finish composed of a stucco mixed with fine pebbles and dashed against a wall. Also called spatter dash.

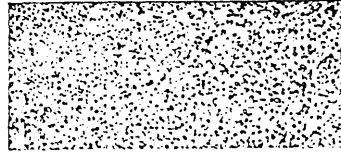
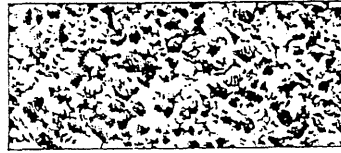
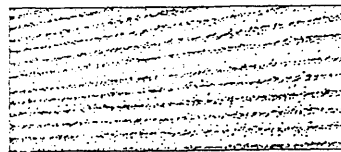
**molding plaster**  
A plaster used in ornamental work, consisting of finely ground gypsum and hydrated lime.

**running mold**  
A sheet-metal template cut to the desired profile, backed with wood, and pushed along between temporary grounds or rules to form a plaster molding along the angle between a wall and ceiling. Also called horsed mold.

**horse**  
The wooden support for the sheet-metal template of a running mold.



**parqueting**  
Fine ornamental plasterwork, esp. exterior plasterwork bearing designs in low relief. Also, parquet.



# PLASTER

## lath

Any of a number of suitable surfaces for receiving plasterwork, as gypsum lath, metal lath, wood lath, masonry, or brickwork.

## wood lath

A thin, narrow strip of wood used with other strips to form latticework, a backing for plaster or stucco, or a support for slates or other roofing material.

## furring

The attaching of wood strips or metal channels to a wall or other surface, as to provide an even base for lath or a finish material, or to provide an air space between a wall and a finish material.

## metal lath

A plaster base fabricated of expanded metal or of wire fabric, painted or galvanized for corrosion resistance.

## expanded-metal lath

Metal lath fabricated by slitting and expanding a sheet of steel alloy to form a stiff network with diamond-shaped openings.

## rib lath

An expanded-metal lath having V-shaped ribs to provide greater stiffness and permit wider spacing of the supporting framing members.

## self-centering lath

A rib lath used over steel joists as formwork for concrete slabs, or as lathing in solid plaster partitions.

## self-furring lath

Expanded-metal, welded-wire, or woven-wire lath that is dimpled to space itself from the supporting surface, creating a space for the keying of plaster or stucco.

## wire lath

Welded- or woven-wire fabric, usually with a paper backing, used as a base for plaster or stucco.

## paper-backed lath

Expanded-metal or wire lath having a backing of perforated or building paper, used as a base for plaster or stucco.

## corner lath

A strip of expanded-metal lath bent to form a 90° angle, used at an internal corner to prevent cracks in plastering. Also called corner reinforcement.

## strip lath

A narrow strip of expanded-metal lath for reinforcing joints in gypsum lath or junctures between different types of plaster bases.

## scrim

Coarse cotton, fiberglass, or metal mesh, used for bridging and reinforcing a joint or as a base for plastering or painting.

## gypsum lath

Gypsum board having an air-entrained core faced with absorbent paper, used as a base for plaster. Also called rock lath.

## perforated gypsum lath

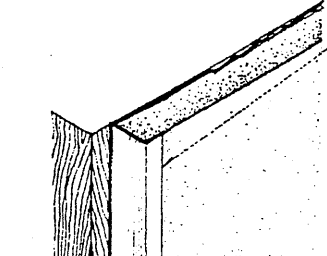
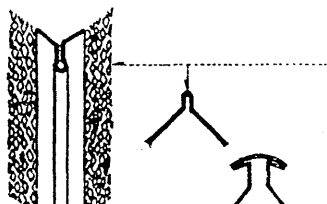
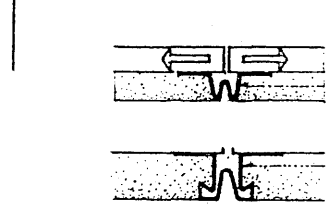
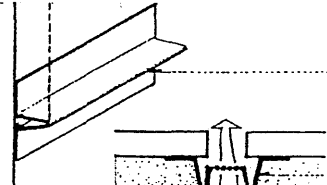
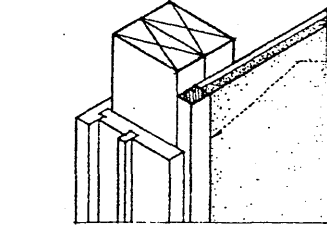
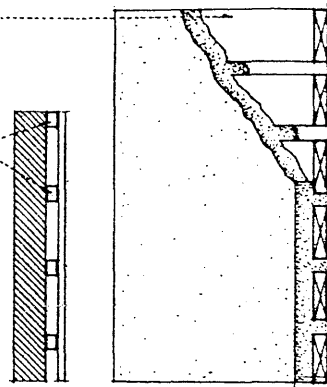
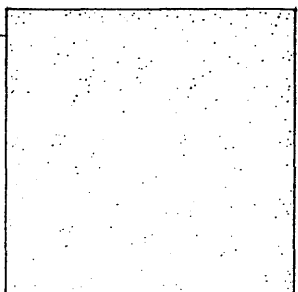
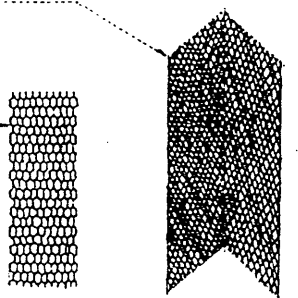
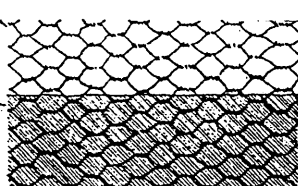
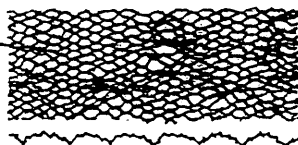
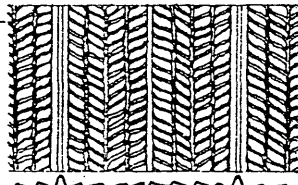
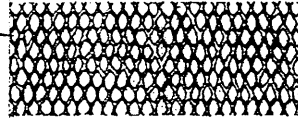
Gypsum lath punched with small holes to provide a mechanical key for plaster.

## insulating gypsum lath

Gypsum lath having an aluminum foil backing that serves as a vapor retarder and reflective thermal insulator.

## veneer base

Gypsum lath having a special paper facing for receiving veneer plaster.



## plaster bond

The adhesion of plaster to its base produced by mechanical or chemical means.

## mechanical bond

The physical keying of a plaster coat to a plaster base or with another plaster coat roughened by scoring.

## bonding agent

A chemical substance applied to a suitable substrate to improve its bond with a succeeding layer.

## suction

The absorption of water from a finish coat of plaster by the basecoat or gypsum lath, resulting in a better bond.

## ground

A strip of wood or a metal bead used at an opening as a guide for plastering to a given thickness and as a stop for the plasterwork.

## screed

A strip of wood, plaster, or metal applied to a surface to be plastered to serve as a guide for making a true surface and plastering to a given thickness.

## base screed

A preformed metal screed for separating a plastered surface from another material along the base of a wall.

## vented screed

A perforated metal screed for venting a concealed space behind a plastered surface.

## expansion screed

A preformed metal screed applied over joints in gypsum lath to control cracking.

## control joint

A preformed metal strip installed to relieve shrinkage, temperature, or structural stresses within a large plastered or stuccoed area.

## corner bead

A preformed metal strip having two expanded or perforated flanges and variously shaped projecting noses, used as a ground and to strengthen and protect an external angle in plasterwork or a gypsum board surface. Also called angle bead.

## bullnose corner bead

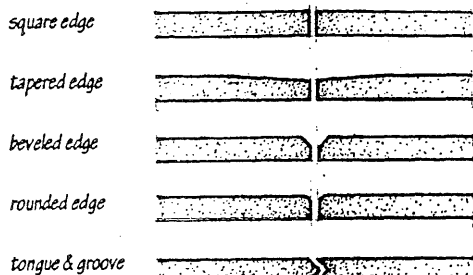
A corner bead having a rounded edge.

## arch corner bead

A flexible corner bead for forming and reinforcing the curved portion of an arched opening.

## casing bead

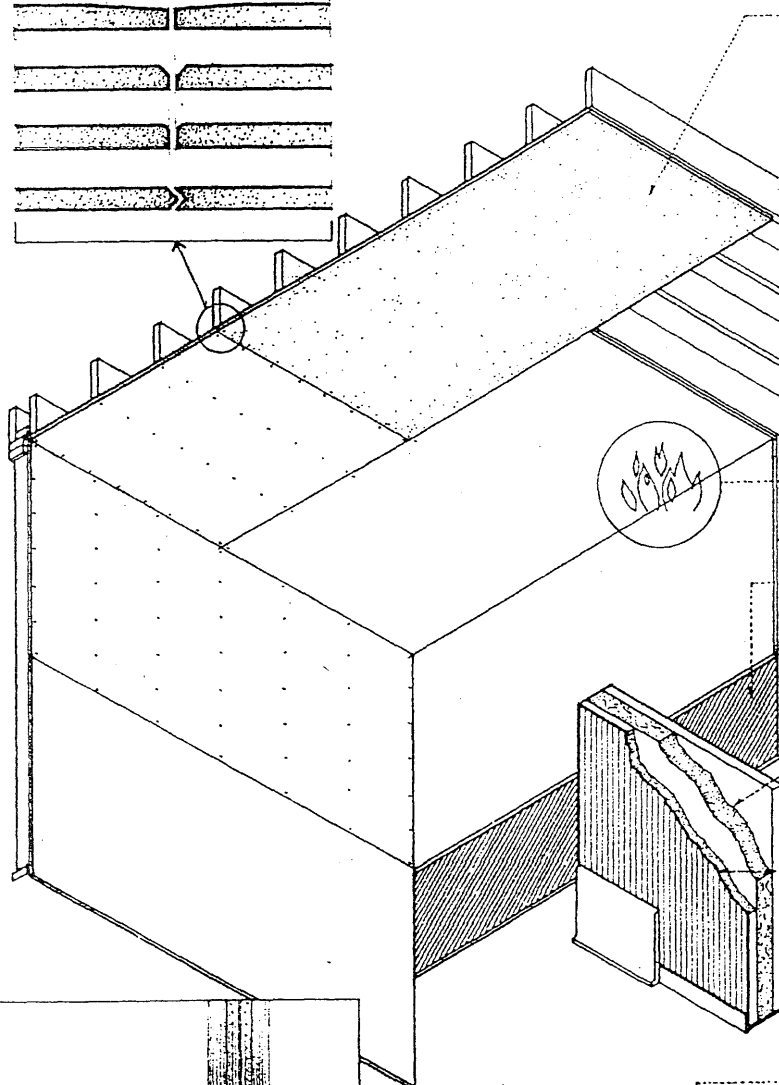
A preformed metal strip having an expanded or perforated flange and variously shaped ends, used as a ground and to strengthen and reinforce the edges of plasterwork or a gypsum board surface.



**wallboard**  
Any of various sheet materials used in covering a wall or ceiling as a substitute for plaster or paneling.

**gypsum board**  
A sheet material having a gypsum core faced with paper on each side, used for covering walls or as lath. Also called drywall, plasterboard.

**Sheetrock**  
Trademark for a brand of gypsum board.

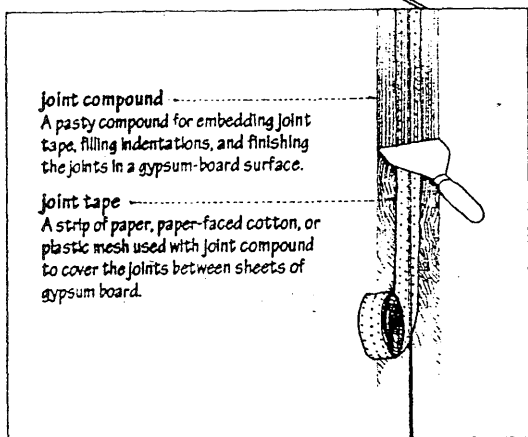


**type-X gypsum board**  
A gypsum board having a core containing additives for increased fire resistance.

**backing board**  
An inexpensive gypsum board used as the base layer in a multilayer assembly for increased rigidity, sound insulation, and fire resistance.

**coreboard**  
A gypsum board 1-in. (25.4 mm) thick, used as a base in solid gypsum-board partitions and for lining shafts.

**prefinished gypsum board**  
A gypsum board having a decorative vinyl or printed paper surface.

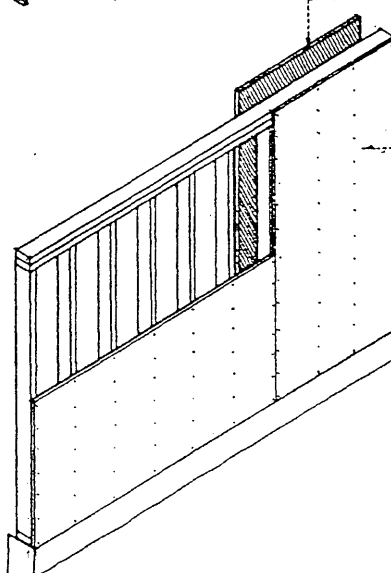


**joint compound**  
A pasty compound for embedding joint tape, filling indentations, and finishing the joints in a gypsum-board surface.

**joint tape**  
A strip of paper, paper-faced cotton, or plastic mesh used with joint compound to cover the joints between sheets of gypsum board.

**foil-backed gypsum board**  
Gypsum board having an aluminum foil backing that serves as a vapor retarder and as a reflective thermal insulator when the foil faces a 3/4 in. (19 mm) minimum air space.

**gypsum sheathing**  
A gypsum board having a fire-resistant core and faced with a water-repellent paper, used as exterior sheathing.



# PLASTIC

Any of numerous synthetic or natural organic materials that are mostly thermoplastic or thermosetting polymers of high molecular weight and that can be molded, extruded, or drawn into objects, films, or filaments.

## polymerization

A chemical reaction in which the molecules of a monomer combine to form larger molecules that contain repeating structural units of the original molecules.

## monomer

A molecule of low molecular weight that can be chemically bound as a unit of a polymer.

## polymer

A compound of high molecular weight formed by polymerization and consisting essentially of repeating structural units.

## high polymer

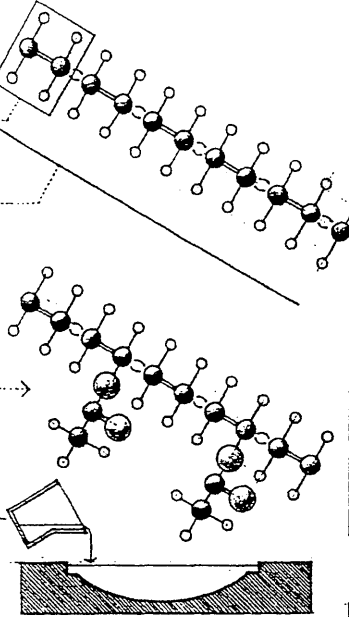
A polymer consisting of molecules that are large multiples of monomers.

## copolymer

A compound of high molecular weight formed by polymerizing two or more different monomers together.

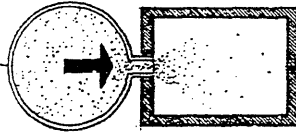
## casting

A method of shaping a plastic object by pouring the material into a mold and allowing it to harden without the use of pressure.



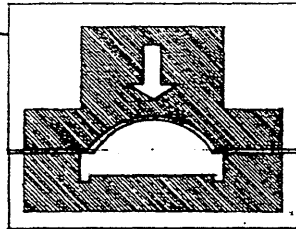
## blow molding

A method of forming hollow ware by injecting air under pressure into a molten mass, as of a thermoplastic or glass, and shaping the material within a mold.



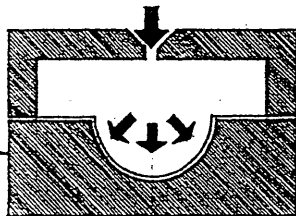
## injection molding

A method of forming a thermoplastic, thermoset, metal, or ceramic material by rendering it fluid in a heating chamber and then forcing it under high pressure into a closed mold.



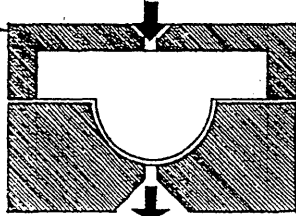
## compression molding

A method of forming thermosetting plastic by closing a mold on it, forming the material by heat and pressure.



## transfer molding

A method of forming thermosetting plastic by softening it in one chamber before it is forced into an adjacent mold where it is cured under heat and pressure.



## thermoforming

A method of shaping a thermoplastic sheet by heating and forcing it against the contours of a mold by heat and pressure.

## pressure forming

A method of thermoforming a plastic sheet by forcing it against the contours of a mold with compressed air.

## vacuum forming

A method of thermoforming a plastic sheet by evacuating the space between the sheet and the contours of a mold.

## resin

Any of numerous solid or semisolid organic substances prepared by polymerization and used with fillers, stabilizers, and other components to form plastics.

## filler

A relatively inert substance added to modify the bulk, strength, heat resistance, electrical resistance, or working properties of a resin.

## stabilizer

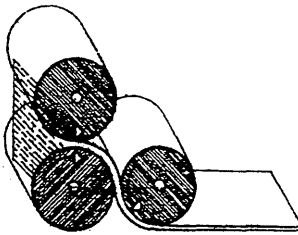
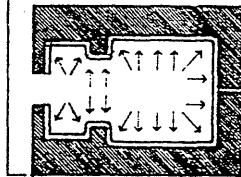
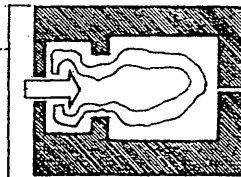
A substance added to prevent or retard the degradation of a plastic when exposed to the ultraviolet radiation or other environmental conditions.

## plasticizer

Any of various substances added to a resin to increase its workability and flexibility.

## catalyst

A substance that causes or accelerates a chemical reaction without itself undergoing a permanent change in composition.



## calendaring

A method of producing plastic film or sheeting by passing the material between a series of revolving, heated rollers.

## sheeting

A thin form of plastic, having a thickness very small in proportion to its length and width.

## film

Sheeting having a nominal thickness not greater than 10 mils.

## thermoplastic

A plastic capable of softening or fusing when heated without a change in any inherent properties, and of hardening again when cooled.

## acrylic resin

Any of a class of thermoplastic resins used for casting or molding plastic parts that are exceptionally transparent, tough, and resistant to weather and chemicals, or as the main ingredient in coatings, adhesives, and caulking compounds.

## Lucite

Trademark for a brand of transparent acrylic resin.

## Plexiglas

Trademark for a brand of light, transparent, weather-resistant acrylic resin.

## polycarbonate

A tough, transparent thermoplastic characterized by its high-impact strength and used for lighting fixtures, safety glazing, and hardware.

## Lexan

Trademark for a brand of tough polycarbonate used for shatterproof windows.

## polyethylene

A tough, light, and flexible thermoplastic used esp. in the form of sheeting and film for packaging, dampproofing, and as a vapor retarder. Also called polythene.

## polypropylene

A tough, thermoplastic that is resistant to heat and chemicals and used for pipe fittings, electrical insulation, and carpeting fibers.

## polystyrene

A hard, tough, stable thermoplastic that is easily colored and molded, expanded, or rolled into sheeting.

## acrylonitrile-butadiene-styrene

A thermoplastic used for making plastic pipes and hardware products that are tough, rigid, and resistant to heat and chemicals. Abbr.: ABS

## vinyl

Any of various tough, flexible plastics made from polyvinyl resin.

## polyvinyl resin

Any of a class of thermoplastic resins formed by polymerizing or copolymerizing a vinyl compound. Also called vinyl resin.

## polyvinyl chloride

A white, water-insoluble thermoplastic widely used in the manufacture of floor coverings, insulation, and piping. Abbr.: PVC

## polyvinyl butyral

A thermoplastic resin used chiefly as the interlayer of safety glass.

## nylon

Any of a class of thermoplastics characterized by extreme toughness, strength, and elasticity and capable of being extruded into filaments, fibers, and sheets.

**thermosetting plastic**

A plastic that becomes permanently rigid when heated and cannot be softened again. Also called **thermoset**.

**polyurethane**

Any of various thermoplastic or thermosetting resins used in flexible and rigid foams, elastomers, and resins for sealants, adhesives, and coatings.

**polyester**

Any of a group of thermosetting resins used in the manufacture of plastics and textile fibers.

**fiberglass-reinforced plastic**

A polyester reinforced with glass fibers and used in translucent roofs and skylights, facings for sandwich panels, and molded plumbing fixtures.

**Dacron**

Trademark for a brand of strong, wrinkle-resistant polyester fiber.

**Mylar**

Trademark for a brand of strong, thin polyester film used in photography, recording tapes, and electrical insulation.

**epoxy resin**

Any of various thermosetting resins capable of forming tight cross-linked polymer structures characterized by toughness, strong adhesion, and high corrosion and chemical resistance, used esp. in surface coatings and adhesives.

**melamine resin**

Any of a class of thermosetting resins formed by the interaction of melamine and formaldehyde and used for molded products, adhesives, and surface coatings.

**phenolic resin**

Any of a class of hard, heat-resistant thermosetting resins formed by the condensation of phenol with formaldehyde and used for molded products, adhesives, and surface coatings. Also called **phenoplast**.

**Bakelite**

Trademark for a brand of dark phenolic resin, invented by Dr. Leo Baekeland in 1916, and used for telephone receivers, radio cabinets, electric insulators, and molded plastic hardware.

**urea-formaldehyde resin**

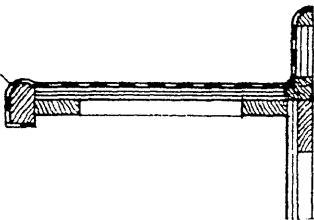
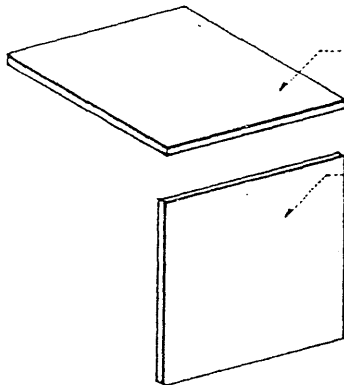
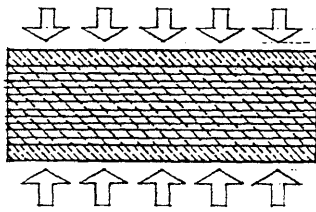
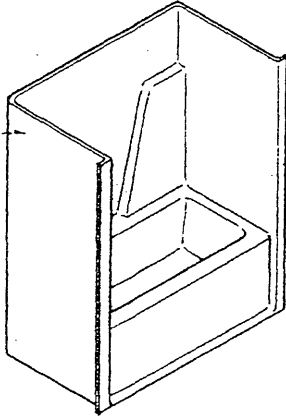
Any of various thermosetting synthetic resin made by condensing urea with formaldehyde and used in appliance housings, electrical devices, adhesives, and surface coatings.

**service temperature**

The maximum temperature at which a plastic can be continuously employed without a noticeable reduction in any of its inherent properties.

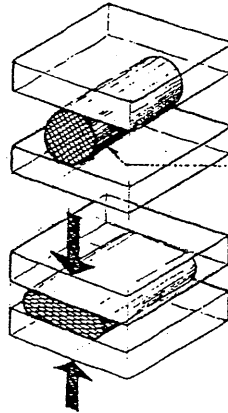
**softening point**

The temperature at which a plastic changes from a rigid to a soft state.



**postforming**

A method of shaping a fully or partially cured thermosetting laminate over a mold by heat and pressure.



**rubber**

A material made by chemically treating and toughening natural rubber, valued for its elasticity, nonconduction of electricity, and resistance to shock and moisture.

**natural rubber**

A highly elastic solid substance, essentially a polymer of isoprene, obtained by coagulating the milky juice of rubber trees and plants. Also called **India rubber**.

**foam rubber**

A light, spongy, cellular rubber made by foaming latex before vulcanization.

**vulcanization**

The treatment of rubber with sulfur and heat to impart greater elasticity, strength, and durability.

**synthetic rubber**

An elastomer similar to natural rubber in properties and uses, produced by the polymerization of an unsaturated hydrocarbon, as butylene or isoprene, or by the copolymerization of hydrocarbons with styrene or butadiene.

**elastomer**

Any of various polymers having the elastic properties of natural rubber, as butyl rubber or neoprene.

**butyl rubber**

A synthetic rubber having exceptional resistance to sunlight and unusually low gaseous permeability, produced by polymerizing butylene and used in roofing membranes and waterproofing barriers.

**Butyl**

Trademark for a brand of butyl rubber.

**neoprene**

A synthetic rubber characterized by superior resistance to oils and sunlight, and used in paints, roofing membranes, flashing, gaskets, and bearings.

**silicone rubber**

A rubber made from silicone elastomers and noted for its retention of flexibility, resilience, and tensile strength over a wide temperature range.

**silicone**

Any of a group of polymers containing alternating silicon and oxygen atoms, characterized by thermal stability, chemical inertness, and extreme water repellence, and used in adhesives, lubricants, protective coatings, and synthetic rubber.

**laminate**

A product made by uniting two or more layers of material by an adhesive or other means, as plywood and plastic laminate.

**plastic laminate**

A hard surfacing material consisting of superposed layers of paper impregnated with melamine and phenolic resins, fused together under heat and pressure.

**high-pressure laminate**

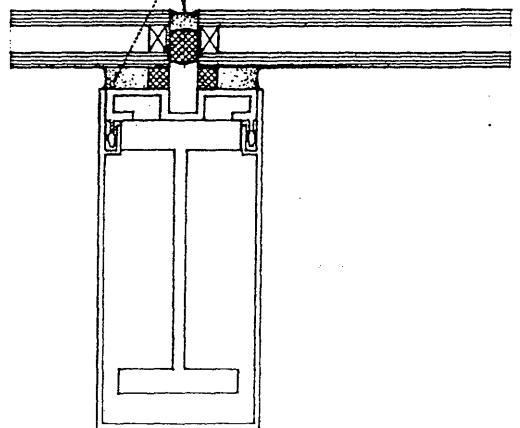
A plastic laminate molded and cured in the range of pressures from 1,200 to 2,000 psi (84 to 140 kg per sq. cm), used for surfacing countertops and cabinetry.

**low-pressure laminate**

A plastic laminate molded and cured with a maximum pressure of 400 psi (28 kg per sq. m), used in vertical and low-wear applications.

**Formica**

Trademark for a brand of plastic laminate.



# PLATE

A rigid, planar, usually monolithic structure that disperses applied loads in a multidirectional pattern, with the loads generally following the shortest and stiffest routes to the supports.

## plate action

The manner in which an applied load is transmitted to the supports of a plate in a multidirectional pattern.

A plate can be envisioned as a series of adjacent beam strips interconnected continuously along their lengths.

As an applied load is transmitted to the supports through bending of one beam strip, the load is distributed over the entire plate by vertical shear transmitted from the deflected strip to adjacent strips.

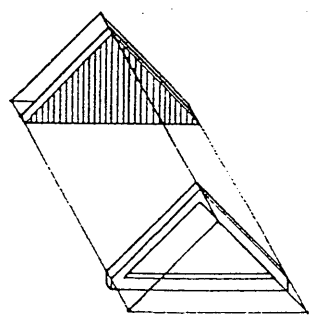
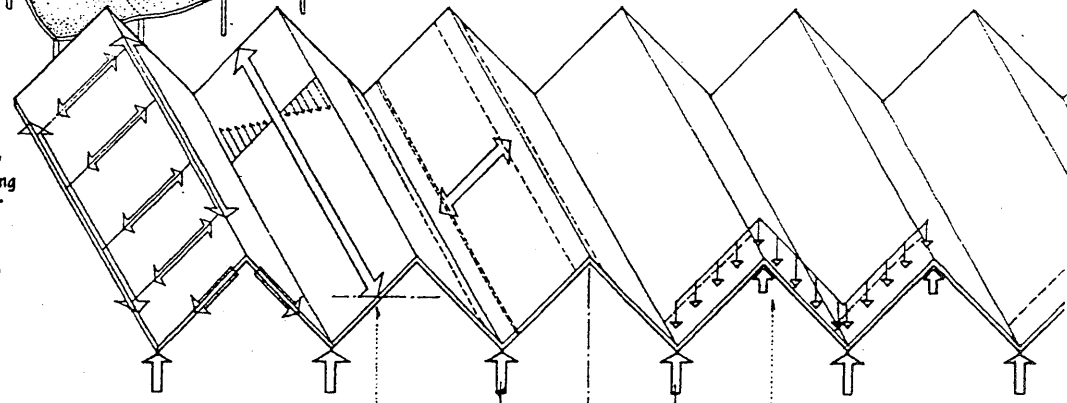
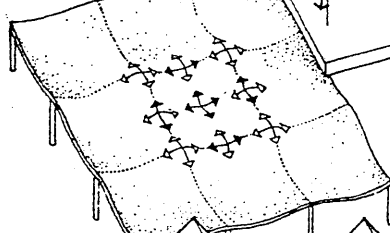
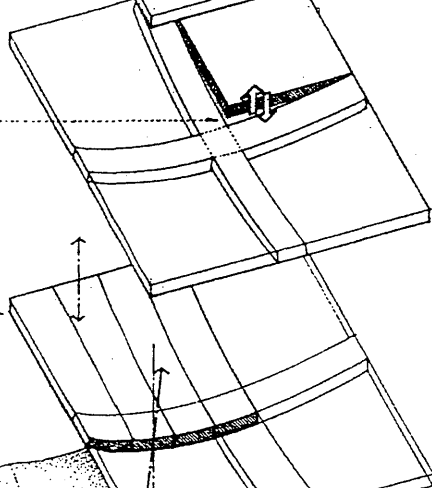
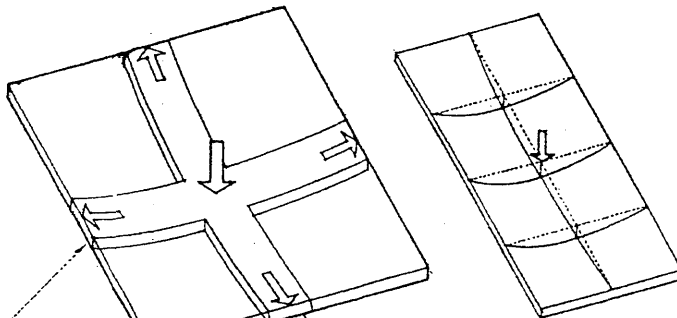
The bending of one beam strip also causes twisting of transverse strips, whose torsional resistance increases the overall stiffness of the plate. Therefore, while bending and shear transfer an applied load in the direction of the loaded beam strip, shear and twisting transfer the load at right angles to the loaded strip.

## continuous plate

A plate extending as a structural unit over three or more supports in a given direction. A continuous plate is subject to lower bending moments than a series of discrete, simply supported plates.

## folded plate

A plate structure composed of thin, deep elements joined rigidly along their boundaries and forming sharp angles to brace each other against lateral buckling. The resulting stiffness of the cross section enables a folded plate to span relatively long distances.

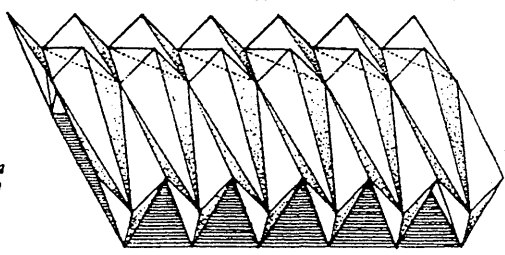


Each plane behaves as a beam in the longitudinal direction.

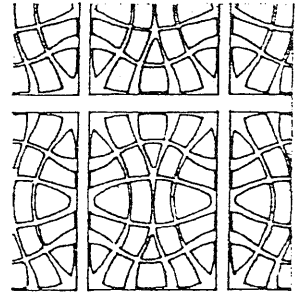
In the short direction, the span is reduced by each fold acting as a rigid support.

Transverse strips behave as a continuous beam supported at fold points.

Vertical diaphragms or rigid frames stiffen a folded plate against deformation of the fold profile.

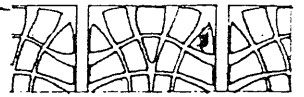


A plate should be square or nearly square to ensure that it behaves as a two-way structure. As a plate becomes more rectangular than square, the two-way action decreases and a one-way system spanning the shorter direction develops since the shorter plate strips are stiffer and carry a greater portion of the load.



## isostatic plate

A plate reinforced by a grid of curved ribs which follow the isostatics of the structure.

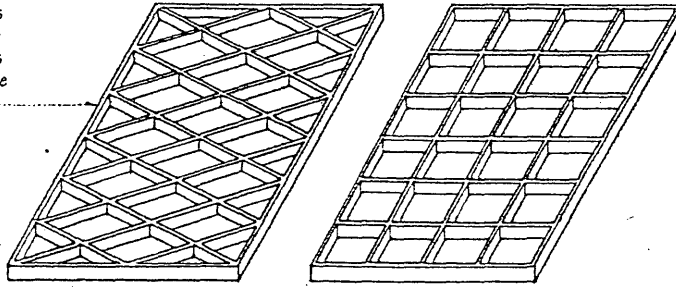


## isostatics

Lines of principal stress indicating the flow of bending stresses and along which torsional shear stresses are zero.

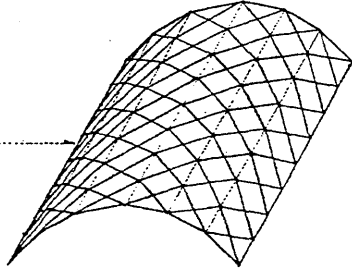
**skew grid**

A grid structure of beams or flat trusses running obliquely to the sides of the base rectangle in order to equalize their spans and stiffnesses. The shorter spans at the corners result in additional stiffness.



**Lamella roof**

A vaulted roof composed of lamellae forming a crisscross pattern of parallel arches skewed with respect to the sides of the covered space.



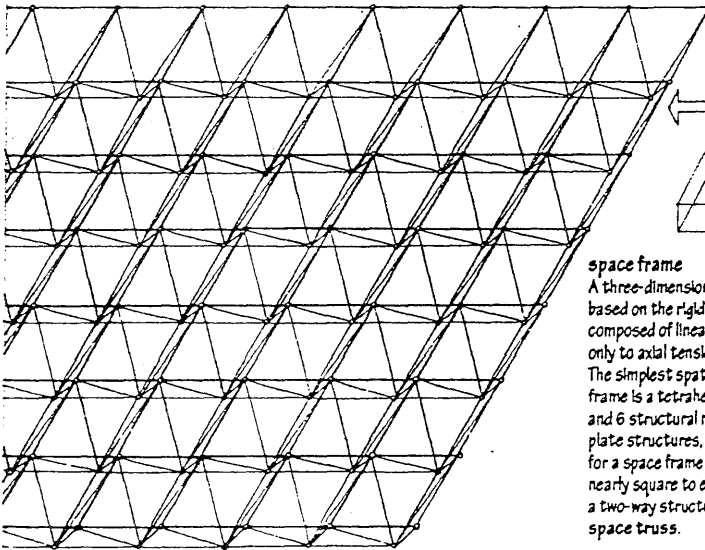
**lamella**

One of the relatively short timber, metal, or reinforced-concrete elements forming a lamella roof.

**grid structure**

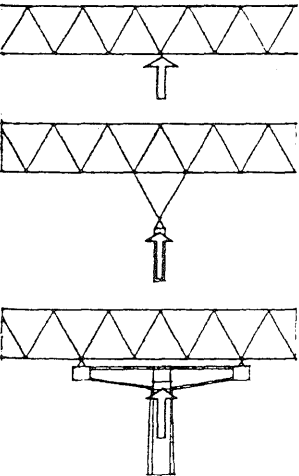
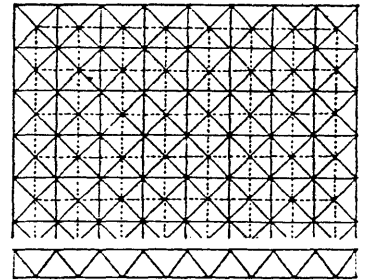
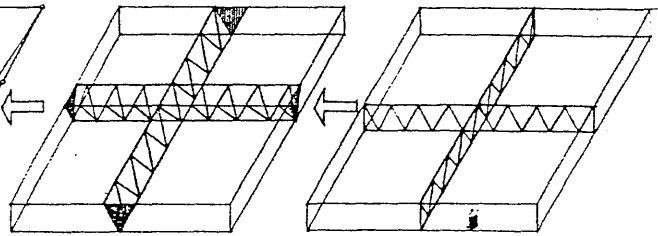
A framework of crisscrossing beams connected at their intersections by rigid joints and dispersing an applied load in two directions according to the physical properties and dimensions of the beam elements.

All beam elements participate in carrying a load through a combination of bending and twisting. If two beams at right angles to each other are identical, they share an applied load equally in bending. If the beams have different lengths, however, the shorter beam carries more of the load since the stiffness of a beam is inversely proportional to the cube of its length and a load generally follows the path of least resistance to supports. For example, if two beams have a span ratio of 1:2, their stiffnesses will have a ratio of 1:8. Consequently, the shorter beam will carry  $\frac{8}{9}$  of the load. The torsional resistance of beams against the twisting induced by the bending of a transverse beam increases the stiffness of the grid.

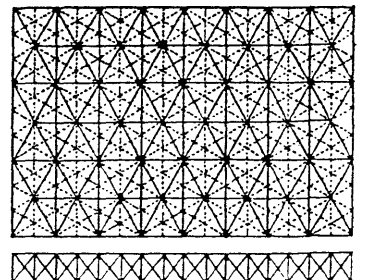
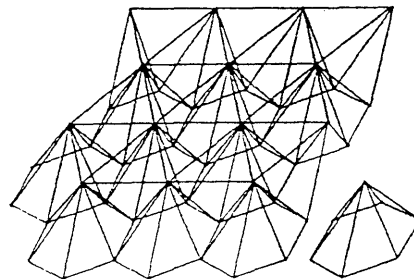
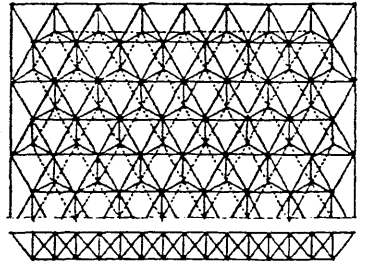
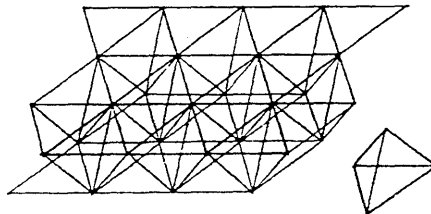


**space frame**

A three-dimensional structural frame based on the rigidity of the triangle and composed of linear elements subject only to axial tension or compression. The simplest spatial unit of a space frame is a tetrahedron having 4 joints and 6 structural members. As with plate structures, the supporting bay for a space frame should be square or nearly square to ensure that it acts as a two-way structure. Also called space truss.



Increasing the bearing area of the supports increases the number of members into which shear is transferred and reduces the forces in the members.



# PLUMBING

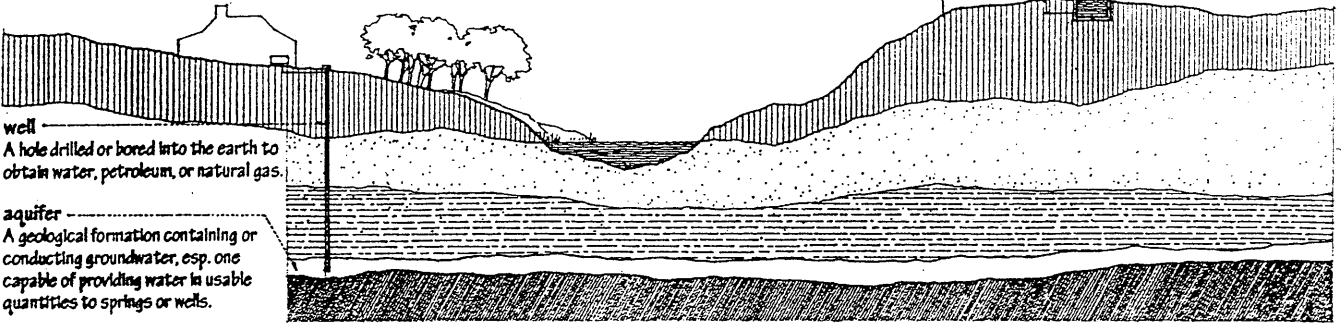
The system of pipes, valves, fixtures, and other apparatus of a water supply or sewage system.

## water supply

The supply of purified water to a community, usually including facilities for storing and distributing this water, as reservoirs and pipelines.

## cistern

A reservoir or tank for storing or holding water or other liquid, as rainwater collected from a roof, for use when required.



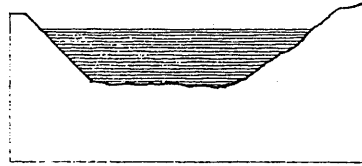
**well**  
A hole drilled or bored into the earth to obtain water, petroleum, or natural gas.

**aquifer**  
A geological formation containing or conducting groundwater, esp. one capable of providing water in usable quantities to springs or wells.

**artesian well**  
A well in which water rises under pressure from a permeable stratum overlaid by impermeable rock.

**drawdown**  
A lowering of the water surface level, as in a well, or the distance by which the groundwater level is lowered as a result of pumping.

**reservoir**  
A natural or artificial place where water is collected and stored for use, esp. water for supplying a community, irrigating land, or furnishing power.

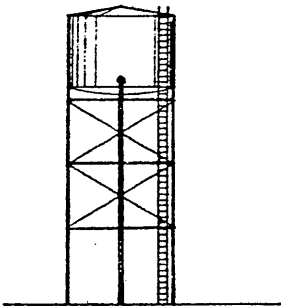
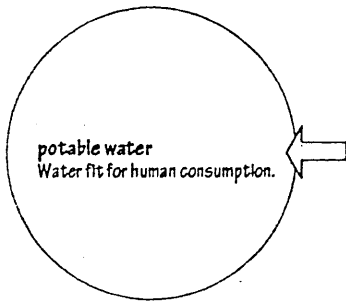


**water tower**  
A tower into which water is pumped to a height sufficient to maintain a desired pressure for distributing to customers, or for firefighting.

**potable water**  
Water fit for human consumption.

**water treatment**  
The act or process of making water more potable or useful, as by purifying, clarifying, or softening.

**raw water**  
Water that requires treatment before it can be used for drinking.



**corporation stop**  
A valve controlling the flow of water or gas from a main to a service pipe. Also called corporation cock.

**curb box**  
A vertical enclosure with a removable cover providing access to a curb cock. Also called Buffalo box.

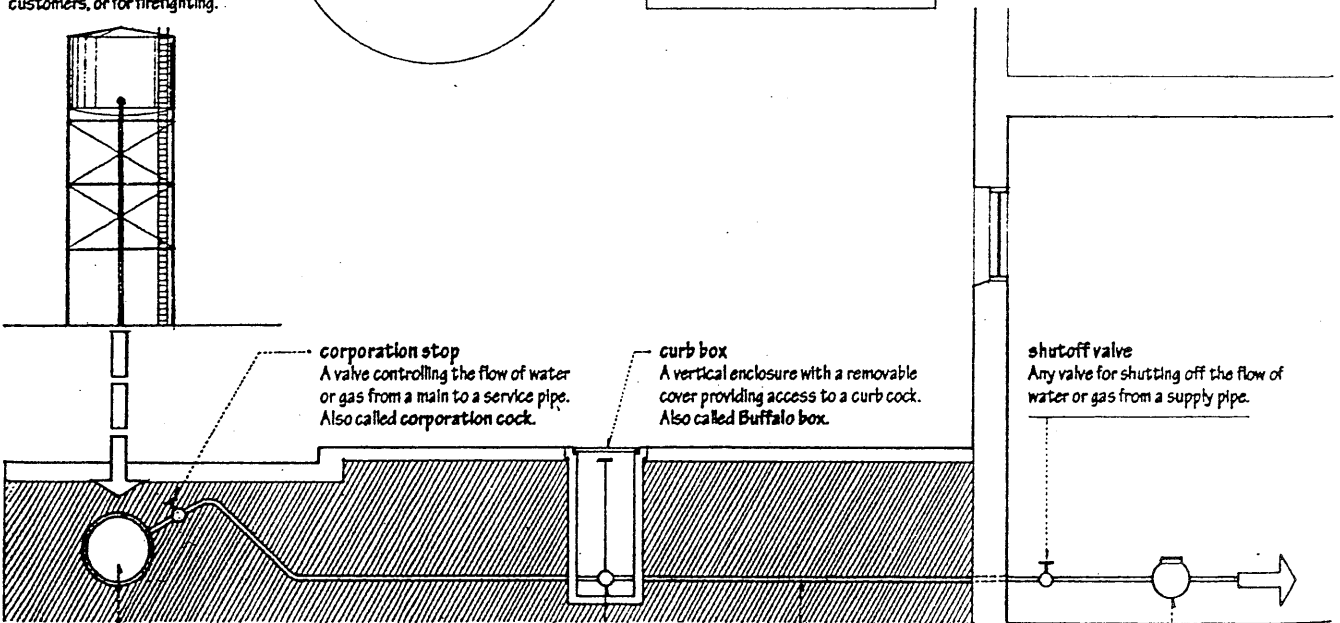
**shutoff valve**  
Any valve for shutting off the flow of water or gas from a supply pipe.

**water main**  
A main pipe or conduit through which a public or community water system conveys water to all service connections.

**curb cock**  
A control valve for shutting off the water supply to a building in case of an emergency, installed in a water service pipe and operated by means of a long key inserted through a curb box. Also called curb stop.

**service pipe**  
A pipe connecting a building to a water or gas main, usually installed by or under the jurisdiction of a public utility.

**water meter**  
A device for measuring and recording the quantity of water that passes through a pipe.





**water system**

A system of pipes, valves, and fixtures for distributing and using water in a building.

**gravity water system**

A water supply and distribution system in which the water source is set at a height sufficient to maintain adequate supply pressure throughout the water distribution system. Also called *downfeed distribution system*.

**head**

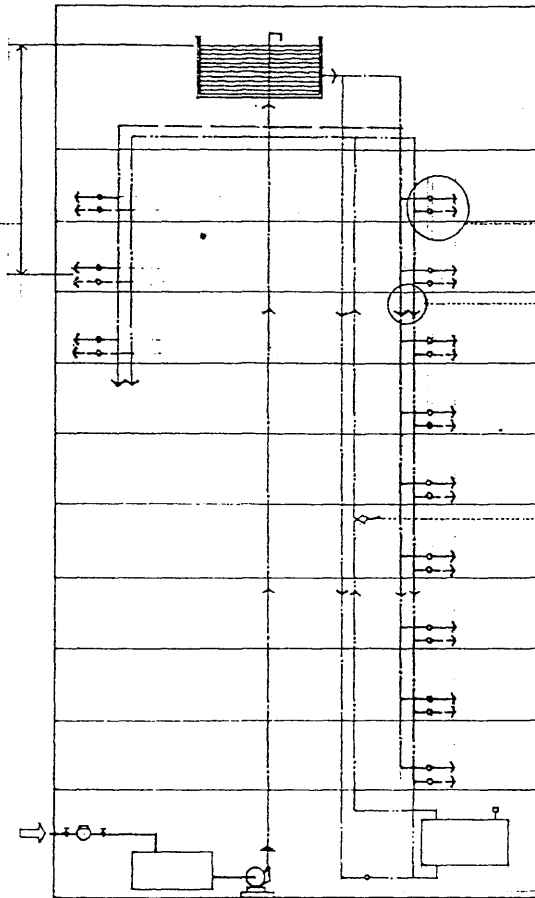
The pressure at the lower of two given points in a liquid, expressed in terms of the vertical distance between the points. Also called *pressure head*.

**pressure drop**

A loss of head or fluid pressure between two points of a pipe or across a valve, due to hydraulic friction.

**fixture unit**

A unit for measuring the probable demand for water by a plumbing fixture, or the probable discharge of liquid waste from the fixture, equivalent to 7½ gallons or one cubic foot per minute.



**branch**

Any member of a piping system other than a main, riser, or stack.

**riser**

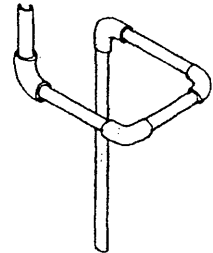
A vertical pipe, conduit, or duct in a utility system.

**main**

A principal pipe, conduit, or duct in a utility system.

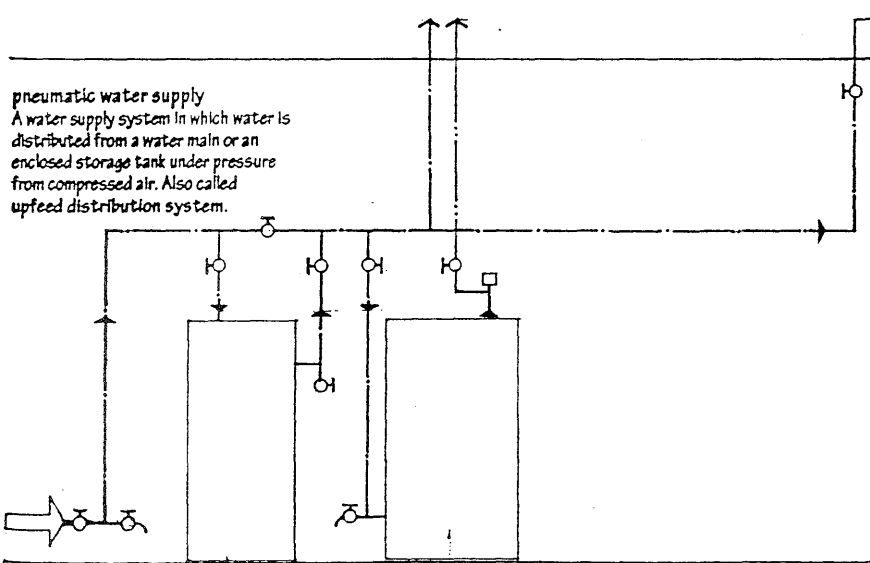
**expansion bend**

An expansion joint of pipe and pipe fittings permitting thermal expansion to occur in a long run of hot-water piping. Also called *expansion loop*.



**pneumatic water supply**

A water supply system in which water is distributed from a water main or an enclosed storage tank under pressure from compressed air. Also called *upfeed distribution system*.



**hose bibb**

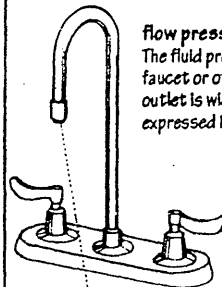
A threaded exterior faucet, as for attaching a garden hose, often attached to the side of a house at about the height of a sill. Also called *hosecock*, *sillcock*.

**faucet**

A device for controlling the flow of a liquid from a pipe by opening or closing an orifice. Also called *spigot*, *tap*.

**flow pressure**

The fluid pressure in a supply pipe at a faucet or other outlet while the faucet or outlet is wide open and water is flowing, expressed in psi (N/m<sup>2</sup>).



**mixing faucet**

A faucet having a single outlet for water from separately controlled hot-water and cold-water taps. Also called *mixer*.

**aerator**

A sleeve-like device for mixing air with the water flowing from the end of a spigot.

**anti-scald faucet**

A faucet having a thermostatically controlled valve for maintaining the desired water temperature regardless of pressure or flow.

**water softener**

An apparatus that removes calcium and magnesium salts from hard water by ion exchange in order to give the water more efficient sudsing ability with soap.

**water heater**

An electric or gas appliance for heating water to a temperature between 120°F and 140°F (50°C and 60°C) and storing it for use.

**hard water**

Water containing dissolved salts of calcium or magnesium and forming soap lather with difficulty.

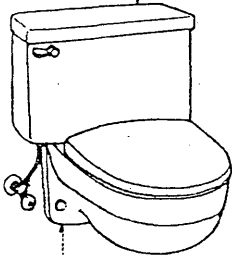
# PLUMBING

## plumbing fixture

Any of various receptacles for receiving water from a water system and discharging the liquid waste into a drainage system.

## sanitary ware

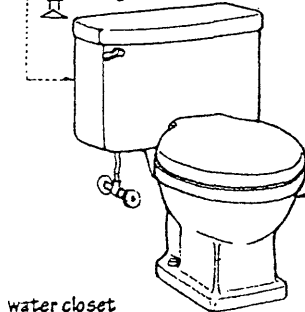
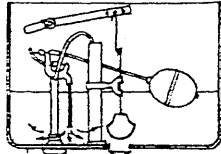
Plumbing fixtures, as sinks and toilet bowls, made of vitreous china, porcelain enamel, or enameled metal.



**wall-hung**  
Designed to be attached to or hung from a wall.

## ball cock

A device for regulating the supply of water in a flush tank by means of a hollow floating ball which by its rise or fall shuts or opens a supply valve. Also called float valve.



## water closet

A fixture consisting of a ceramic bowl with a detachable, hinged seat and lid and a device for flushing with water, used for defecation and urination. Also called toilet.

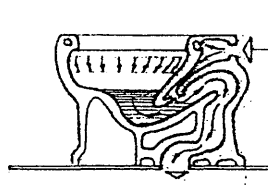
## flushometer valve

A valve that supplies a fixed quantity of water to fixtures for flushing purposes when actuated by direct water pressure.



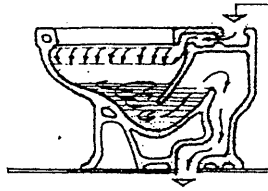
## siphon-jet

A toilet bowl in which the flushing water enters through the rim and siphonic action initiated by a water jet draws the contents of the bowl through the trapway.



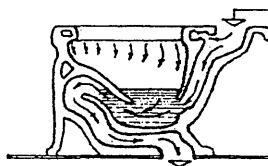
## reverse-trap

A toilet bowl similar to the siphon-jet, but having a smaller water surface and trapway.



## siphon-vortex

A toilet bowl similar to the siphon-jet, but having the flushing water directed through the rim to create a vortex that scours the bowl.



## wash-down

A toilet bowl having a simple washout action and emptying through a small, irregular passage; prohibited by some health codes.

## bidet

A basinlike fixture designed to be straddled for bathing the genitals and posterior parts of the body.

## urinal

A flushable fixture used by men for urinating.

## toilet partition

A panel forming an enclosure around a water closet for privacy in a public lavatory.

## bath tub

An oblong tub to bathe in, esp. one that is a permanent fixture in a bathroom.

## shower

A bath in which water is sprayed on the body from an overhead nozzle or showerhead.

## grab bar

A bar attached to a wall near a bath tub or shower to provide a hand grip for a person who is bathing.

## receptor

The shallow base pan of a stall shower.

## lavatory

A bowl or basin with running water for washing the face and hands.

## sink

A basin, as in a kitchen or laundry, connected with a water supply and drainage system for washing.

## disposal

An electrical device in the drain of a sink, for grinding food wastes to be washed down the drain. Also called *disposer*.

## laundry tray

A deep sink for washing clothes.

## service sink

A deep sink used in janitorial work. Also called *slop sink*.

## water hammer

The concussion and banging noise that results when a volume of water moving in a pipe suddenly stops or loses momentum.

## air chamber

A compartment in a water system containing air that elastically compresses and expands to equalize the pressure and flow of water in the system. Also called *air cushion*.

## overflow

An outlet, pipe, or receptacle for excess liquid.

## backflow

A flow of a liquid opposite to the usual or desired direction.

## back-siphonage

A backflow of used or contaminated water from a plumbing fixture into a pipe supplying potable water due to negative pressure in the pipe.

## backwater valve

A valve for preventing flowing liquid, as sewage, from reversing its direction. Also called *backflow valve*.

## flow rate

The rate of discharge from a plumbing fixture, equal to the total number of gallons discharged per minute divided by 7.5 and expressed in fixture units.

## backsplash

A vertical panel of waterproof material attached to the wall behind a countertop or stovetop to protect against splashed liquids.

## air gap

The clear vertical distance between the spout of a faucet or other outlet of a supply pipe and the flood level of a receptacle.

## flood level

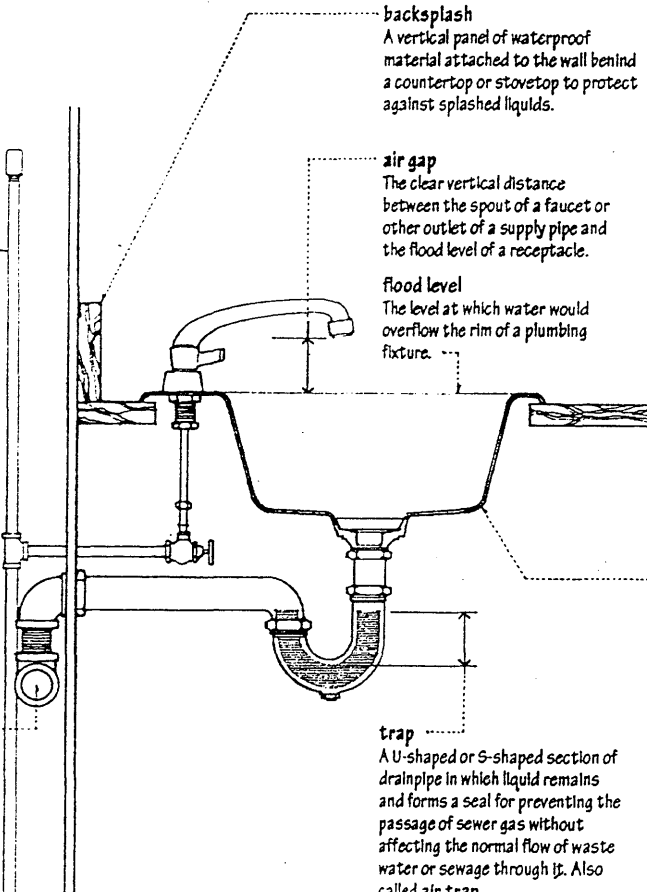
The level at which water would overflow the rim of a plumbing fixture.

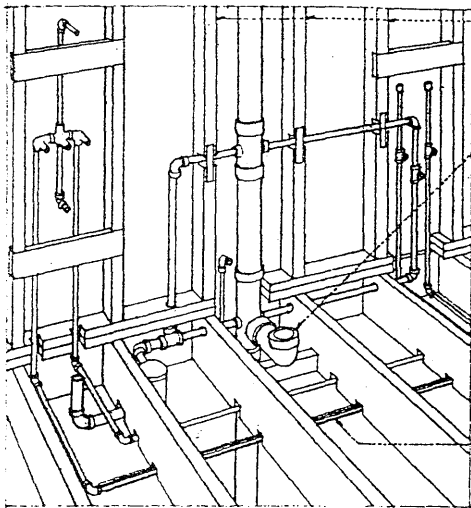
## trap

A U-shaped or S-shaped section of drainpipe in which liquid remains and forms a seal for preventing the passage of sewer gas without affecting the normal flow of waste water or sewage through it. Also called *air trap*.

## drum trap

A cylindrical trap closed on the bottom and having a cover plate for access, usually installed on the drain line from a bathtub.





**plumbing wall**  
A wall or partition containing vertical space for a plumbing stack. Also called stack partition.

**closet bend**  
A 90° soil fitting installed directly beneath a water closet.

**developed length**  
The length of a pipeline measured along the centerline of the pipe and pipe fittings.

**molded insulation**  
Thermal insulation premolded to fit around pipes and pipe fittings.

**roughing-in**  
The act or process of installing all parts of a plumbing system that will later be concealed, usually to the fixture connections.

**valve**  
Any device for controlling or stopping the flow of a liquid or gas by a movable part that opens, partially obstructs, or shuts a passage, pipe, inlet, or outlet.

**bonnet**  
The part of a valve casing through which the stem passes and that forms a guide and seal for the stem.

**seat**  
The part or surface of a valve on which the stem is closed to stop flow completely.

**globe valve**  
A valve with a globular body, closed by a disk seating on an opening in an internal wall.

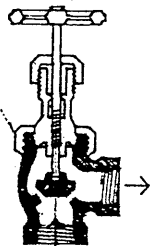
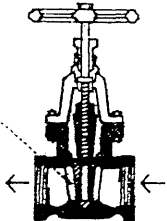
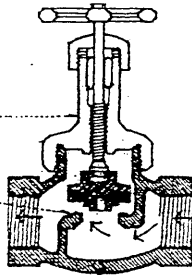
**gate valve**  
A shutoff valve closed by lowering a wedge-shaped gate across the passage.

**angle valve**  
A globe valve having an outlet at a right angle to the inlet.

**alignment valve**  
A washerless valve opened by aligning holes in a disk, cylinder, or ball.

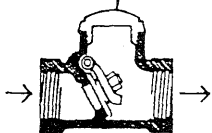
**mixing valve**  
A valve for controlling the relative amount of hot and cold water admitted from separate hot-water and cold-water lines.

**check valve**  
A valve permitting a liquid or gas to flow in one direction only.



**bell-and-spigot**  
A pipe joint made by fitting the end (spigot) of one pipe into the enlarged end (bell) of another pipe and sealing with a caulking compound or a compressible ring.

**gasket**  
A rubber or metal ring inserted between two mating surfaces to make the joint watertight.



**pipe**  
A hollow cylinder of metal or plastic used for the conveyance of water, steam, gas, or other fluid material.

**pipe fitting**  
A standard part, as an elbow, union, or tee, for connecting two or more pipes.

**elbow**  
A pipe fitting having an angled, usually 90° bend. Also called ell, el.

**drop elbow**  
An elbow having lugs for attachment to a wall or joist. Also called drop ell.

**sweep fitting**  
A pipe fitting having a large radius of curvature.

**return bend**  
A 180° bend in a pipe.

**tee**  
A T-shaped pipe fitting for making a three-way joint.

**drop tee**  
A tee having lugs for attachment to a wall or joist.

**sanitary tee**  
A tee having a slight curve in the 90° transition to channel the flow from a branch pipe in the direction of the main.

**wye**  
A Y-shaped pipe fitting for joining a branch pipe with a main, usually at a 45° angle.

**cross**  
A pipe fitting for making a four-way connection.

**sanitary cross**  
A cross having a slight curve in each of the 90° transitions to channel the flow from branch pipes in the direction of the main.

**crossover**  
A U-shaped pipe for bypassing another pipe.

**nipple**  
A short length of pipe with threads on each end, used for joining couplings or other pipe fittings.

**coupling**  
A short length of pipe having each end threaded on the inside, used for joining two pipes of the same diameter.

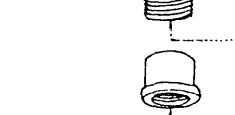
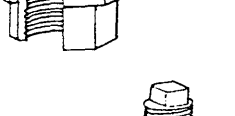
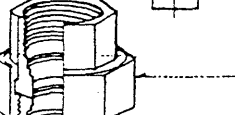
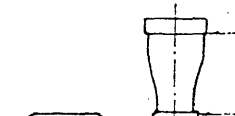
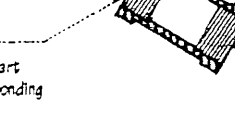
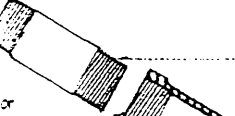
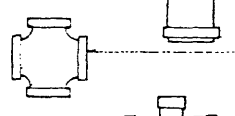
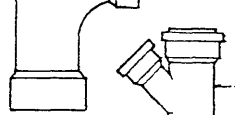
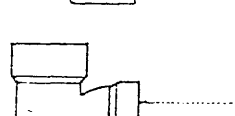
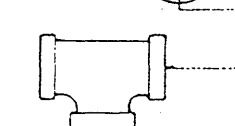
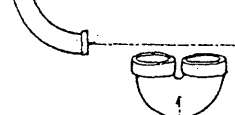
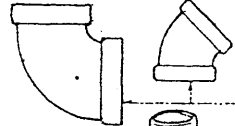
**increaser**  
A coupling increasing in diameter at one end.

**reducer**  
A coupling decreasing in diameter at one end.

**union**  
A coupling device for connecting two pipes neither of which can be turned, consisting of two internally threaded end pieces which are tightened around the pipe ends to be joined, and an externally threaded center piece, which draws the two end pieces together as it is rotated.

**plug**  
An externally threaded fitting for closing the end of a pipe.

**cap**  
An internally threaded fitting for enclosing the end of a pipe.



# PLUMBING

## drainage system

A system of pipes, traps, and other apparatus for conveying sewage, waste water, or rainwater to a public sewer or a private treatment facility.

## drain

Any pipe or channel by which a liquid is drawn off.

## fixture drain

A drain extending from the trap of a plumbing fixture to a junction with a waste or soil stack.

## branch drain

A drain connecting one or more fixtures to a soil or waste stack.

## stack

A vertical waste pipe or vent pipe serving a number of floors.

## soil stack

A vertical soil pipe.

## soil pipe

Any pipe carrying the discharge from water closets or urinals to the building drain or building sewer.

## waste stack

A vertical waste pipe.

## waste pipe

Any pipe carrying the discharge from plumbing fixtures other than water closets or urinals.

## indirect waste pipe

A waste pipe that is not connected directly with a drainage system, but discharges into it through a properly trapped plumbing fixture.

## branch interval

A length of soil or waste stack corresponding to a story height but never less than 8 ft. (2.4 m), within which the horizontal branch drains from one floor are connected.

## fall

The downward slope of a pipe, conduit, or channel, expressed either as a percentage or in inches per foot.

## wet vent

An oversized pipe functioning both as a soil or waste pipe and a vent.

## cleanout

A pipe fitting with a removable plug giving access to a soil or waste pipe for inspection or cleaning.

## sump pump

A pump for removing the accumulations of liquid from a sump.

## sump

A pit or reservoir serving as a drain or receptacle for water or other liquids.

## invert

The lowest point on the interior of a drain pipe or sewer where the liquid is deepest.

## vent system

A system of pipes supplying a flow of air to or from a drainage system or providing a circulation of air within the system to protect trap seals from siphonage and back pressure.

## stack vent

The extension of a soil or waste stack above the highest horizontal drain connected to the stack. Also called soil vent, waste vent.

## battery

A group of two or more similar plumbing fixtures discharging into a common waste or soil branch.

## vent

A pipe connecting a drain near one or more traps to a vent stack or stack vent.

## relief vent

A vent that provides circulation of air between a drainage and a venting system by connecting a vent stack to a horizontal drain between the first fixture and the soil or waste stack.

## loop vent

A circuit vent that loops back and connects with a stack vent instead of a vent stack.

## common vent

A single vent serving two fixture drains connected at the same level. Also called dual vent.

## vent stack

A vertical vent installed primarily to provide circulation of air to or from any part of a drainage system.

## branch vent

A vent connecting one or more individual vents with a vent stack or stack vent.

## individual vent

A vent connecting a fixture drain to a main or branch vent. Also called revent.

## circuit vent

A vent serving two or more traps and extending from in front of the last fixture connection of a horizontal branch to the vent stack.

## back vent

A vent installed on the sewer side of a trap.

## continuous vent

A vertical vent formed by a continuation of the drain line to which it connects.

## fresh-air inlet

A vent pipe admitting fresh air into the drainage system of a building, connected to the building drain at or before the building trap.

## building sewer

A drain connecting a building drain to a public sewer or private treatment facility. Also called house sewer.

## sewer

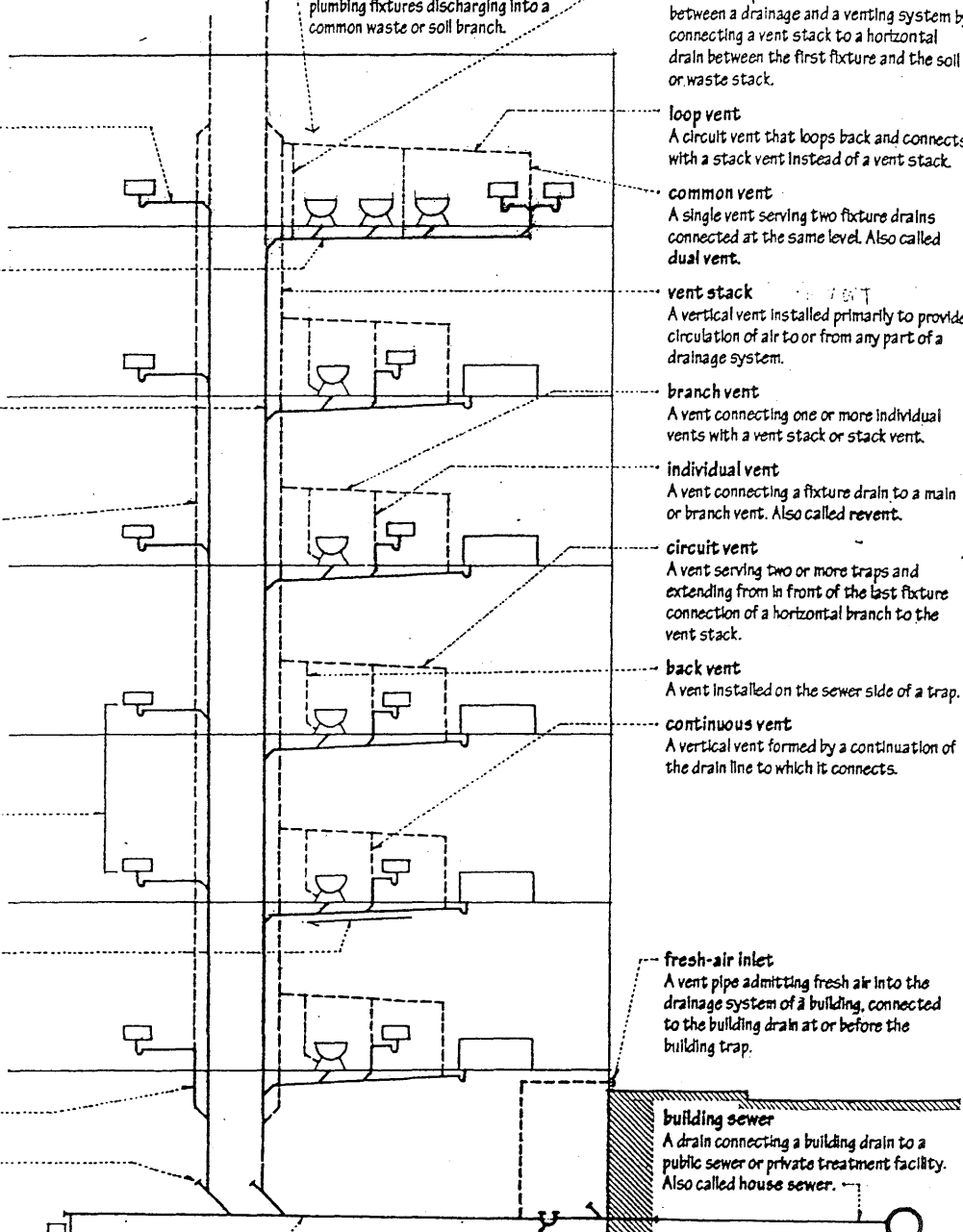
A pipe or other artificial conduit, usually underground, for carrying off sewage and other liquid waste to a treatment plant or other point of disposal.

## sanitary sewer

A sewer conveying only the sewage from plumbing fixtures and excluding storm water.

## sewage

The liquid waste containing animal or vegetable matter in suspension or solution that passes through a sewer.



## building drain

The lowest part of a drainage system that receives the discharge from soil and waste stacks inside the walls of a building and conveys it by gravity to the building sewer. Also called house drain.

## building trap

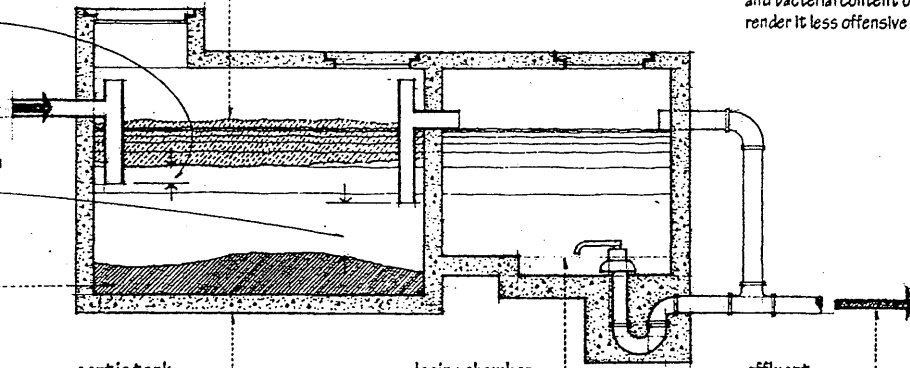
A trap installed in the building drain to prevent the passage of sewer gases from the building sewer to the drainage system of a building. Not all plumbing codes require a building trap. Also called house trap.

**scum**  
A layer of sewage matter that rises to the surface of the sewage in a septic tank.

**scum clear space**  
The distance between the bottom of the layer of scum and the bottom of the outlet in a septic tank.

**sludge clear space**  
The distance between the top of the sludge and the bottom of the outlet in a septic tank.

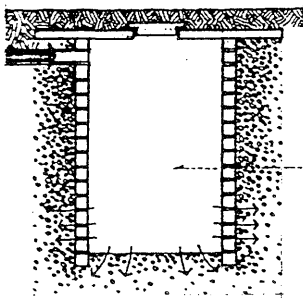
**sludge**  
Sediment that settles out of sewage, forming a semi-solid mass on the bottom of a septic tank.



**sewage treatment plant**  
Structures and appurtenances for receiving the discharge of a sanitary drainage system and reducing the organic and bacterial content of the waste so as to render it less offensive or dangerous.

**cesspool**  
A covered pit for receiving the sewage from a house, having a perforated lining to allow the liquid portion of the sewage to leach into the ground while the sludge is retained in the pit to undergo decomposition. Cesspools are no longer acceptable as a means of sewage disposal.

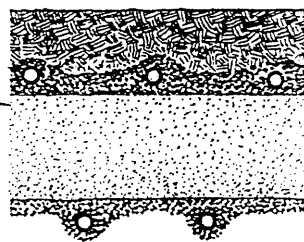
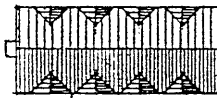
**seepage pit**  
A pit that is lined with a perforated masonry or concrete wall to allow effluent collected from a septic tank to seep or leach into the surrounding soil, sometimes used as a substitute for a drainfield.



**sand filter**  
A filter for cleansing water or purifying effluent, consisting of layers of coarse stone, coarse gravel, and sand becoming finer toward the top.

**subsurface sand filter**  
A sewage filtering system consisting of a number of distribution pipes surrounded by graded gravel, an intermediate layer of clean, coarse sand, and a system of underdrains to carry off the filtered effluent.

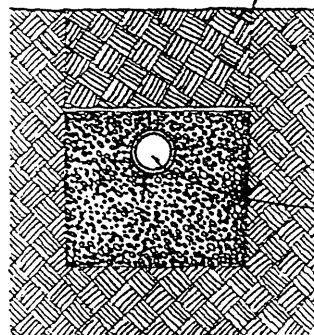
**septic tank**  
A covered watertight tank for receiving the discharge from a building sewer, separating out the solid organic matter which is decomposed and purified by anaerobic bacteria, and allowing the clarified liquid to discharge for final disposal.



**serial distribution**  
A sequence of absorption trenches, absorption beds, or seepage pits so arranged that the total effective absorption area of one is utilized before effluent flows into the next.

**percolation test**  
A test for determining the rate at which a soil will absorb effluent, made by measuring the rate at which the water level drops after a hole is dug in the soil and filled with water.

**dosing chamber**  
A chamber of a large septic tank employing siphonic action to automatically discharge a large volume of effluent when a predetermined quantity has accumulated.



**leach**  
To cause water or other liquid to percolate through something, so as to dissolve out soluble constituents.

**effluent**  
Liquid sewage that has been treated in a septic tank or a sewage treatment plant.

**grease trap**  
A tank installed between a kitchen sink and a house sewer for retaining and removing grease from waste water. Also called grease interceptor.

**distribution box**  
A box through which the flow of effluent from a septic tank is distributed to the drainage tiles of a drainfield. Also called diversion box.

**drainfield**  
An open area containing an arrangement of absorption trenches through which septic-tank effluent from a septic tank may seep or leach into the surrounding soil. Also called absorption field, disposal field.

**absorption trench**  
A narrow trench 12 to 36 in. (305 to 914 mm) wide containing coarse aggregate and a distribution pipe through which the effluent from a septic tank is allowed to seep into the soil.

**absorption bed**  
A trench wider than 36 in. (914 mm), containing coarse aggregate and two or more distribution pipes through which the effluent from a septic tank may seep into the surrounding soil. Also called seepage bed.

**distribution pipe**  
Drain tiles laid with open joints or perforated pipe having sufficient openings for the distribution of the effluent from a septic tank. Also called distribution line.

**drain tile**  
A hollow tile laid end to end with open joints to disperse effluent in a drainfield, or to drain water-saturated soil. Also, drainage tile.

# REINFORCED CONCRETE

**Concrete in which steel reinforcement is embedded in such a manner that the two materials act together in resisting forces. Also called *béton armé*, *ferroconcrete*.**

**plain concrete**  
Concrete having no reinforcement, or reinforced only for drying shrinkage or thermal stresses.

**ferrocement**  
Constructed of cement-sand mortar over a wire mesh that has been preshaped over a mold.

**fiber-reinforced concrete**  
Concrete reinforced with dispersed, randomly oriented fibers of glass or plastic.  
**gfrc**  
Abbreviation for glass-fiber-reinforced concrete.

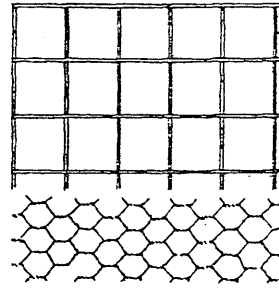
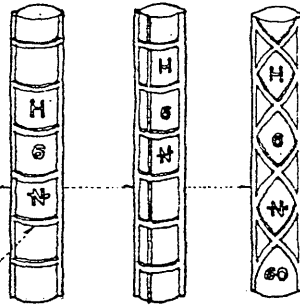
**reinforcement**  
A system of steel bars, strands, or wires for absorbing tensile, shearing, and sometimes the compressive stresses in a concrete member or structure.

**reinforcing bar**  
A steel bar for reinforcing concrete, usually specified by a number equivalent to its diameter in eighths of an inch. Also called *rebar*.

**deformed bar**  
A reinforcing bar not-rolled with surface deformations to develop a greater bond with concrete.

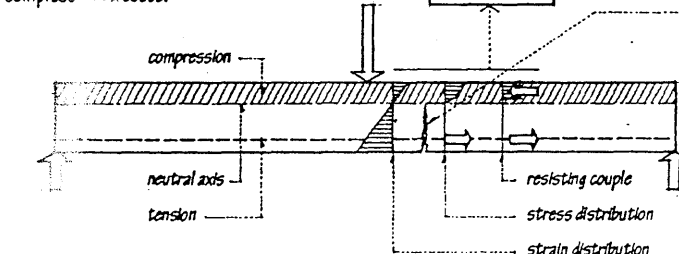
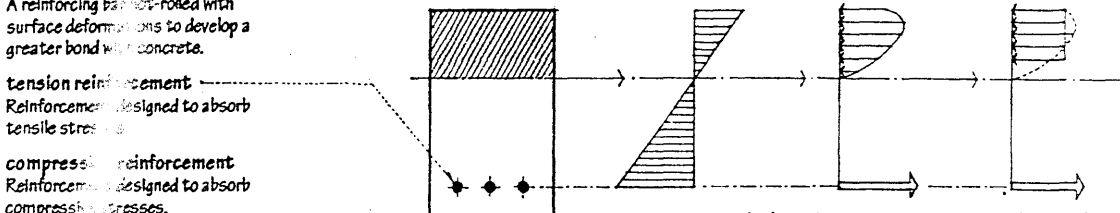
**tension reinforcement**  
Reinforcement designed to absorb tensile stresses.

**compression reinforcement**  
Reinforcement designed to absorb compressive stresses.



**welded-wire fabric**  
A grid of longitudinal and transverse steel wires or bars welded together at all points of intersection, usually specified by the size of the grid in inches and the wire gauge. Also called *welded-wire mesh*.

**woven-wire fabric**  
A mesh of cold-drawn steel wires mechanically twisted together to form hexagonally shaped openings.



**cracked section**  
A concrete section designed or analyzed on the assumption that concrete has no resistance to tensile stresses.

**cracking load**  
A load that causes the tensile stress in a concrete member to exceed the tensile strength of the concrete.

**balanced section**  
A concrete section in which the tension reinforcement theoretically reaches its specified yield strength as the concrete in compression reaches its assumed ultimate strain.

**overreinforced section**  
A concrete section in which the concrete in compression reaches its assumed ultimate strain before the tension reinforcement reaches its specified yield strength. This is a dangerous condition since failure of the section could occur instantaneously without warning.

**underreinforced section**  
A concrete section in which the tension reinforcement reaches its specified yield strength before the concrete in compression reaches its assumed ultimate strain. This is a desirable condition since failure of the section would be preceded by large deformations, giving prior warning of impending collapse.

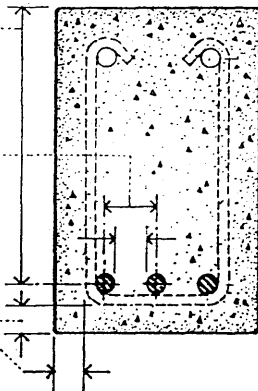
**effective depth**  
The depth of a concrete section measured from the compression face to the centroid of the tension reinforcement.

**bar spacing**  
The center-to-center spacing of parallel reinforcing bars, the resulting clear distance between the bars being regulated by bar diameter, maximum size of coarse aggregate, and thickness of the concrete section.

**cover**  
The amount of concrete required to protect steel reinforcement from fire and corrosion, measured from the surface of the reinforcement to the outer surface of the concrete section.

**bond**  
The adhesion between two substances, concrete and reinforcing bars.

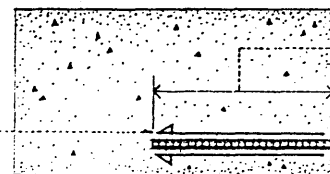
**bond stress**  
The adhesive force per unit area of contact between a reinforcing bar and the surrounding concrete developed at any section of a flexural member.



**effective area of concrete**  
The area of a concrete section between the compression face and the centroid of the tension reinforcement.

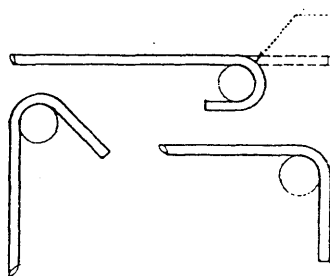
**effective area of reinforcement**  
The product of the right cross-sectional area of reinforcement and the cosine of the angle between its direction and the direction for which its effectiveness is considered.

**percentage reinforcement**  
The ratio of effective area of reinforcement to effective area of concrete at any section of a reinforced concrete member, expressed as a percentage.



**embedment length**  
The length of embedded reinforcement provided beyond a critical section for anchorage.

**anchorage**  
Any of various means, as embedment length or hooked bars, for developing tension or compression in a reinforcing bar on each side of a critical section in order to prevent bond failure or splitting.



**hook**  
A bend or curve given to the end of a tension bar to develop an equivalent embedment length, used where there is insufficient room to develop an adequate embedment length.

**critical section**  
The section of a flexural concrete member at a point of maximum stress, a point of inflection, or a point within the span where tension bars are no longer needed to resist stress.

**standard hook**  
A 90°, 135°, or 180° bend made at the end of a reinforcing bar according to industry standards with a radius based on the bar diameter.

**truss bar**  
A longitudinal bar bent up or down at points of moment reversal in a reinforced concrete beam.

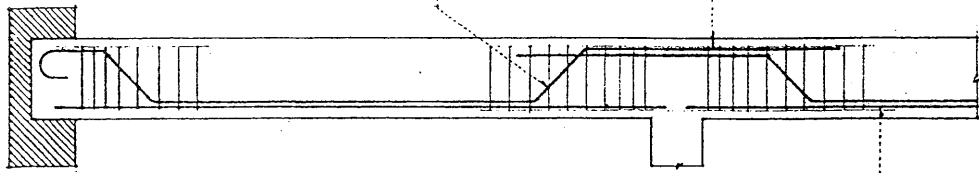
**top bar**  
Any of the longitudinal bars serving as tension reinforcement in the section of a concrete beam or slab subject to a negative moment.

**reinforced concrete beam**  
A concrete beam designed to act together with longitudinal and web reinforcement in resisting applied forces.

**longitudinal reinforcement**  
Reinforcement essentially parallel to the horizontal surface of a slab or to the long axis of a concrete beam or column.

**deep beam**  
A reinforced concrete beam having a depth-to-span ratio greater than 2.5 for continuous spans, or 4.5 for simple spans, subject to nonlinear distribution of stress and lateral buckling.

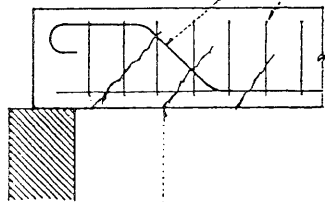
**T-beam**  
A monolithic reinforced concrete construction in which a portion of the slab on each side of a beam acts as a flange in resisting compressive stresses, and the portion of the beam projecting below the slab serves as a web or stem in resisting bending and shear stresses.



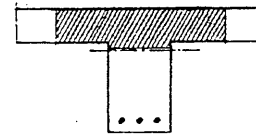
**web reinforcement**  
Reinforcement consisting of bent bars or stirrups, placed in a concrete beam to resist diagonal tension.

**bent bar**  
A longitudinal bar bent to an angle of 30° or more with the axis of a concrete beam, perpendicular to and intersecting the cracking that could occur from diagonal tension.

**bottom bar**  
Any of the longitudinal bars serving as tension reinforcement in the section of a concrete beam or slab subject to a positive moment.

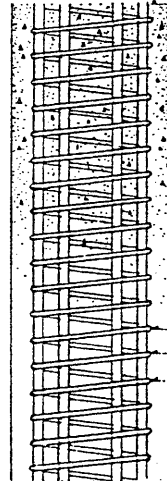
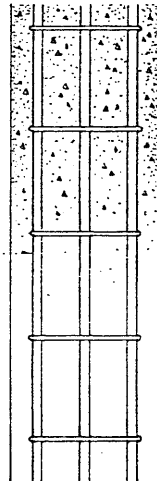


**stirrup**  
Any of the U-shaped or closed-loop bars placed perpendicular to the longitudinal reinforcement of a concrete beam to resist the vertical component of diagonal tension.



**diagonal tension**  
The principle tensile stresses acting at an angle to the longitudinal axis of a beam.

**vertical reinforcement**  
Longitudinal reinforcement placed in a concrete column to absorb compressive stresses, resist bending stresses, and reduce the effects of creep and shrinkage in the column. The effective cross-sectional area of vertical reinforcement should not be less than 0.01 nor more than 0.08 times the gross cross-sectional area of the column, with a minimum of four #5 bars for tied columns and a minimum of six #5 bars for spiral columns.



**reinforced concrete column**  
A concrete column designed to act together with vertical and lateral reinforcement in resisting applied forces. Reinforced concrete columns constituting the principal supports for a floor or roof should have a minimum diameter of 10 in. (254 mm), or if rectangular in section, a minimum thickness of 8 in. (203 mm), and a minimum gross area of 96 sq. in. (61935 sq. mm).

**lateral reinforcement**  
Spiral reinforcement or lateral ties placed in a concrete column to laterally restrain the vertical reinforcement and prevent buckling.

**spiral reinforcement**  
Lateral reinforcement consisting of an evenly spaced continuous spiral held firmly in place by vertical spacers. Spiral reinforcement should have a diameter of at least 3/8 in. (9.5 mm), with a maximum center-to-center spacing between spirals of 1/6 of the core diameter, and a clear spacing between spirals not to exceed 3 in. (76 mm) nor be less than 1 1/8 in. (35 mm) or 1/2 times the size of the coarse aggregate.

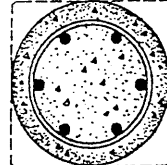
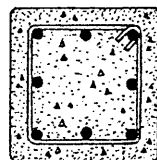
**lap splice**  
A splice for transferring tensile or compressive stresses from one longitudinal bar to another, made by lapping their ends for a length specified in bar diameters.

**butt splice**  
A splice for transferring tensile or compressive stresses from one longitudinal bar to another, made by butting their ends together and connecting them in a positive fashion.

**welded splice**  
A butt splice made by arc-welding the butted ends of two reinforcing bars.

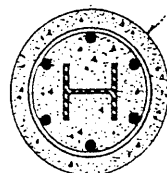
**compression splice**  
A butt splice made by connecting the butted ends of two reinforcing bars with a mechanical fastener, as a sleeve clamp.

**offset bend**  
A bend displacing a section of longitudinal bar to a position parallel to the original bar, used esp. in the vertical reinforcement of concrete columns.



**tied column**  
A concrete column reinforced with vertical bars and individual lateral ties. Lateral ties should have a diameter of at least 3/8 in. (9.5 mm), spaced apart not over 48 tie diameters, 16 bar diameters, or the least dimension of the column section. Each corner and alternate longitudinal bar should be laterally supported by the bend of a tie having an included angle of not more than 135°, with no bar being more than 6 in. (152 mm) clear from such a supported bar.

**spiral column**  
A concrete column with spiral reinforcement enclosing a circular core reinforced with vertical bars.



**compound column**  
A structural steel column encased in concrete at least 2 1/2 in. (64 mm) thick, reinforced with wire mesh.

**composite column**  
A structural steel column thoroughly encased in concrete reinforced with both vertical and spiral reinforcement.

# REINFORCED CONCRETE

## reinforced concrete slab

A rigid planar structure of concrete designed to act together with principal and secondary reinforcement in resisting applied forces.

## principal reinforcement

Reinforcement designed to absorb the stresses from applied loads and moments.

## shrinkage reinforcement

Reinforcement placed perpendicular to the principal reinforcement in a one-way slab to absorb the stresses resulting from shrinkage or changes in temperature. Also called temperature reinforcement.

## topping

A thin layer of high-quality concrete placed over a concrete base to form a floor surface.

## bonding layer

A thin layer of mortar spread on a moistened and prepared existing concrete surface prior to laying a new concrete slab.

## one-way slab

A concrete slab of uniform thickness reinforced in one direction and cast integrally with parallel supporting beams. One-way slabs are suitable only for relatively short spans.

## beam-and-girder slab

A one-way slab supported by secondary beams which in turn are supported by primary beams or girders.

## ribbed slab

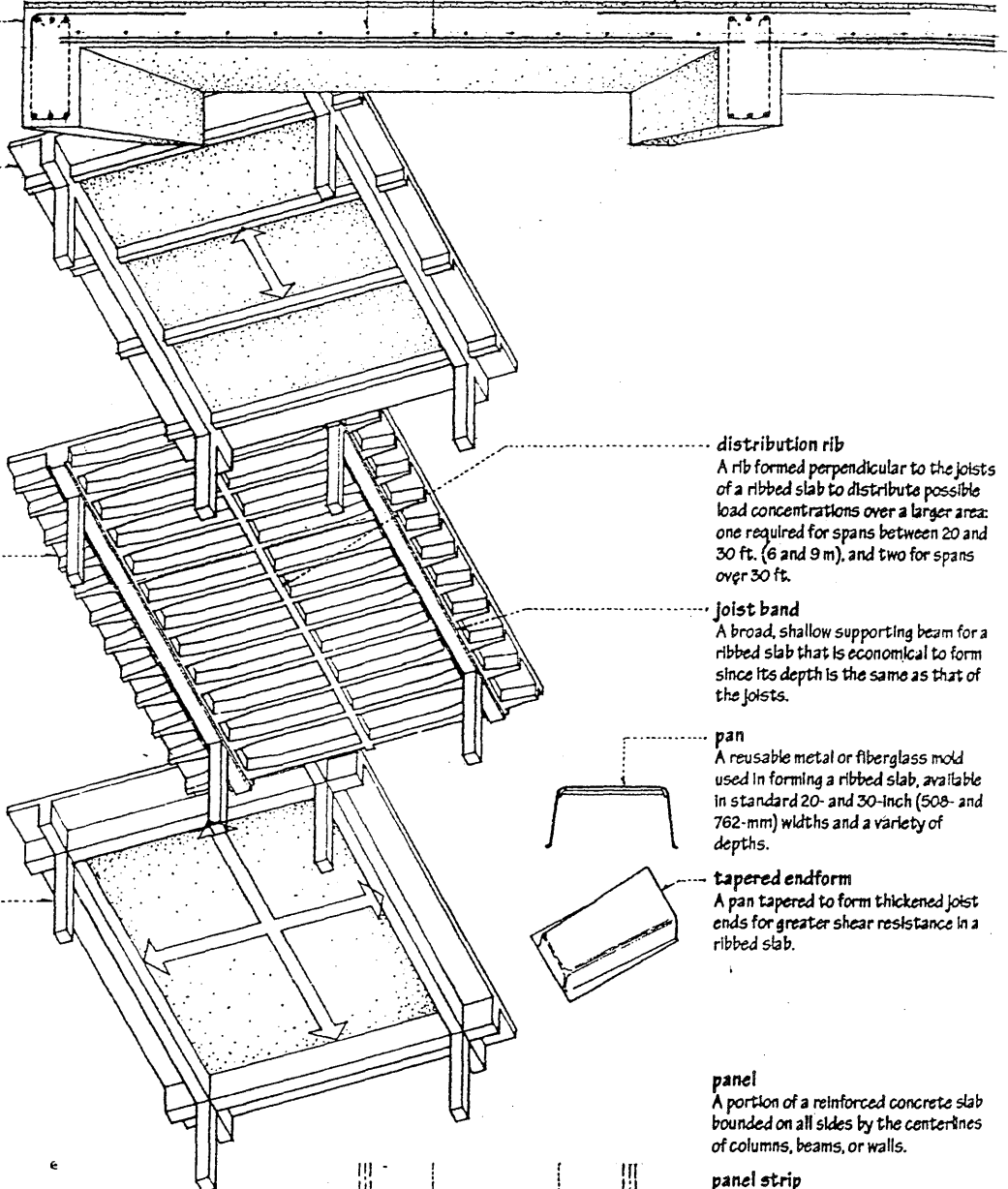
A reinforced concrete slab cast integrally with a series of closely spaced joists which in turn are supported by a parallel set of beams. Ribbed slabs are designed as a series of parallel T-beams and economical for medium spans with light to medium live loads. Also called joist slab.

## two-way slab

A concrete slab of uniform thickness reinforced in two directions and cast integrally with supporting edge beams or bearing walls on four sides. Two-way slabs are economical for medium spans with intermediate to heavy loads.

## continuous slab

A reinforced concrete slab extending as a structural unit over three or more supports in a given direction. A continuous slab is subject to lower bending moments than a series of discrete, simply supported slabs.



## distribution rib

A rib formed perpendicular to the joists of a ribbed slab to distribute possible load concentrations over a larger area: one required for spans between 20 and 30 ft. (6 and 9 m), and two for spans over 30 ft.

## joist band

A broad, shallow supporting beam for a ribbed slab that is economical to form since its depth is the same as that of the joists.

## pan

A reusable metal or fiberglass mold used in forming a ribbed slab, available in standard 20- and 30-inch (508- and 762-mm) widths and a variety of depths.

## tapered endform

A pan tapered to form thickened joist ends for greater shear resistance in a ribbed slab.

## panel

A portion of a reinforced concrete slab bounded on all sides by the centerlines of columns, beams, or walls.

## panel strip

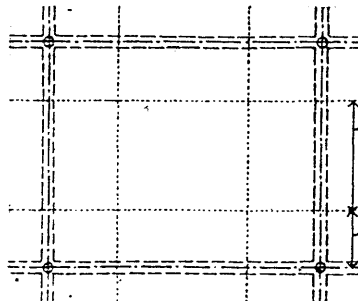
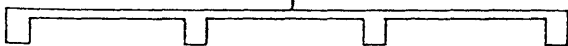
A strip running in each direction of a two-way slab, within which moments per foot are assumed to be constant.

## middle strip

A panel strip, one-half panel in width and symmetrical about the panel centerline.

## column strip

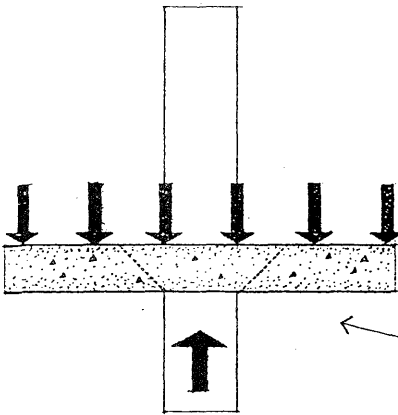
A panel strip occupying the adjacent quarter panels on both sides of a column centerline.





**flat plate**

A concrete slab of uniform thickness reinforced in two or more directions and supported directly by columns without beams or girders. Flat plates are suitable for short to medium spans with relatively light live loads. Since there are no column capitals or drop panels, shear governs the thickness of a flat plate.

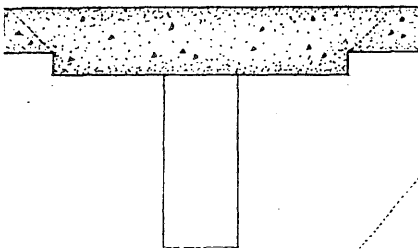


**punching shear**

The potentially high-shearing stress developed by the reactive force of a column on a reinforced concrete slab.

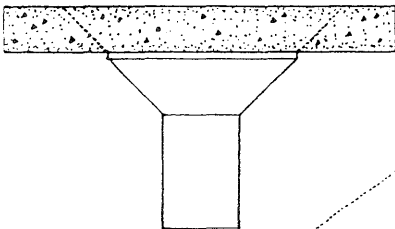
**shear head**

The overstressed region of a reinforced concrete slab at a column support.



**drop panel**

The portion of a flat slab thickened around a column or column capital to increase its resistance to shear.

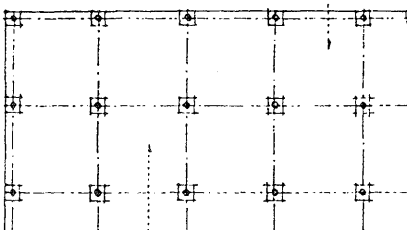


**column capital**

The head of a column support for a flat slab enlarged to increase the plate area in shear.

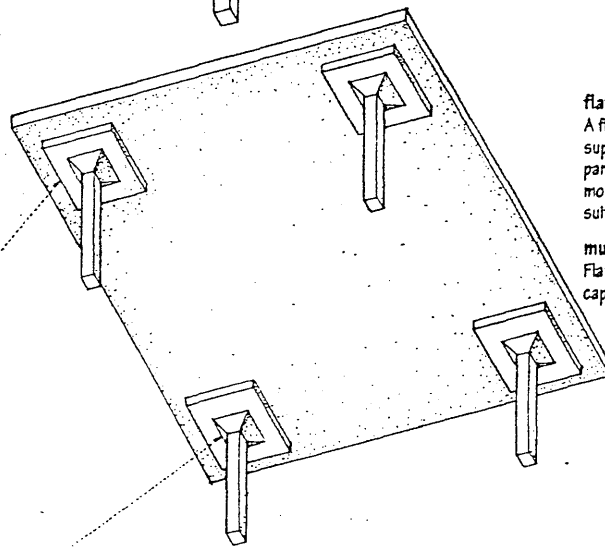
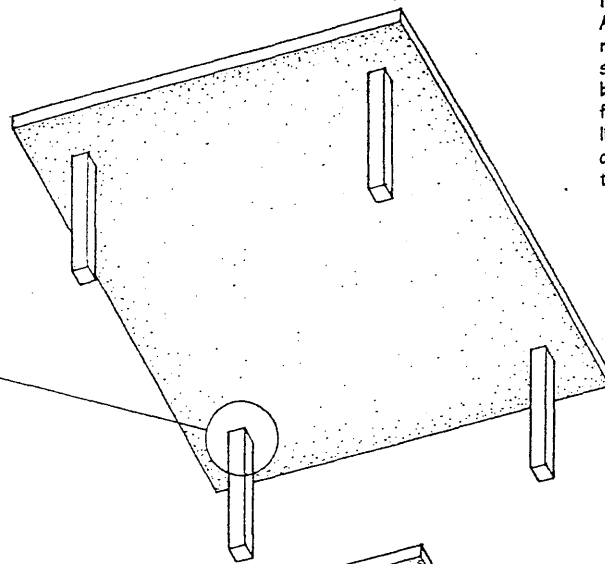
**exterior panel**

A panel of a flat slab having at least one edge which does not adjoin another panel.



**interior panel**

Any panel of a flat slab that adjoins other panels along all four edges.



**flat slab**

A flat plate thickened at its column supports with column capitals and drop panels to increase its shear strength and moment-resisting capacity. Flat slabs are suitable for heavily loaded spans.

**mushroom construction**

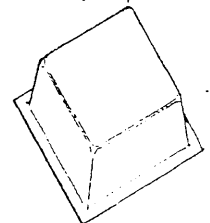
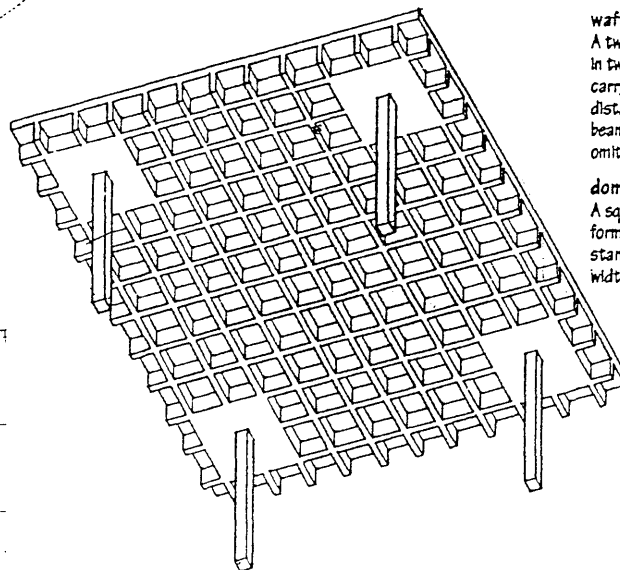
Flat slab construction utilizing column capitals and drop panels.

**waffle slab**

A two-way concrete slab reinforced by ribs in two directions. Waffle slabs are able to carry heavier loads and span longer distances than flat slabs. Supporting beams and drop panels can be formed by omitting dome forms in selected areas.

**dome**

A square metal or fiberglass pan used in forming the ribs of a waffle slab, available in standard 19- and 30-in. (483- and 762-mm) widths and a variety of depths.



# REINFORCED CONCRETE

## precast concrete

A concrete member or product that is cast and cured in a place other than where it is to be installed in a structure.

## solid flat slab

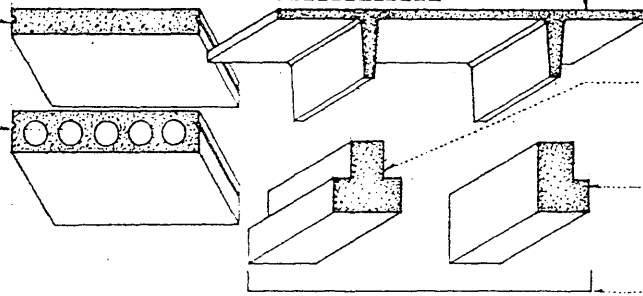
A precast, prestressed concrete plank suitable for short spans and uniformly distributed floor and roof loads.

## hollow-core slab

A precast, prestressed concrete plank internally cored to reduce dead weight. Hollow-core slabs are suitable for medium to long spans and uniformly distributed floor and roof loads.

## topping

A layer of reinforced concrete cast to form a composite structural unit with a precast concrete floor or roof deck.



## single tee

A precast, prestressed concrete slab having a broad, T-shaped cross section.

## double tee

A precast, prestressed concrete slab having two stems and a broad cross section resembling the capital letters TT.

## inverted tee

A precast, prestressed ledger beam having a cross section resembling an inverted capital T.

## L-beam

A precast, prestressed ledger beam having a cross section resembling the capital letter L.

## ledger beam

A reinforced concrete beam having projecting ledges for receiving the ends of joists or slabs.

## prestressed concrete

Concrete reinforced by pretensioning or posttensioning high-strength steel tendons within their elastic limit to actively resist a service load. The tensile stresses in the tendons are transferred to the concrete, placing the entire cross section of a flexural member in compression. The resulting compressive stresses counteract the tensile-bending stresses from the applied load, enabling the prestressed member to deflect less, carry a greater load, or span a greater distance than a conventionally reinforced member of the same size, proportion, and weight.

## prestress

To introduce internal stresses to a concrete member in order to counteract the stresses that will result from an applied load.

## pretension

To prestress a concrete member by tensioning the reinforcing tendons before the concrete is cast. The tendons are first stretched between two abutments until a predetermined tensile force is developed. Concrete is then cast in formwork around the tendons and fully cured. Finally, the tendons are cut, and the tensile stress in the tendons are transferred to the concrete through bond stresses.

## tendon

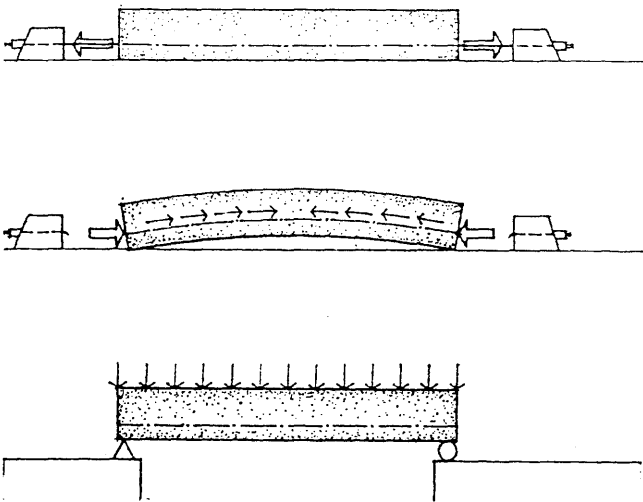
A high-strength steel strand or bar for prestressing concrete.

## strand

A cable composed of high-strength steel wires twisted about a core.

## casting bed

A long horizontal slab on which a number of pretensioned concrete members may be prestressed, formed, and cast simultaneously.



## abutment

A structure for anchoring the reinforcing tendons in the pretensioning of a concrete member.

## anchor

A mechanical device for locking a stressed tendon in position and delivering the prestressing force to the concrete, either permanently in a posttensioned member or temporarily during hardening of a pretensioned concrete member. Also called anchorage.

## jacking force

The tensile force exerted temporarily by a jack in the prestressing of a concrete member.

## jack

A hydraulic device for stretching and stressing tendons in the prestressing of a concrete member.

## initial prestress

The tensile force in the reinforcing tendons transferred to a concrete member at the time of stressing.

## loss of prestress

A reduction in initial prestress resulting from the combined effects of creep, shrinkage, or elastic shortening of the concrete, relaxation of the reinforcing steel, friction losses resulting from the curvature of draped tendons, and slippage at the anchorages.

## final prestress

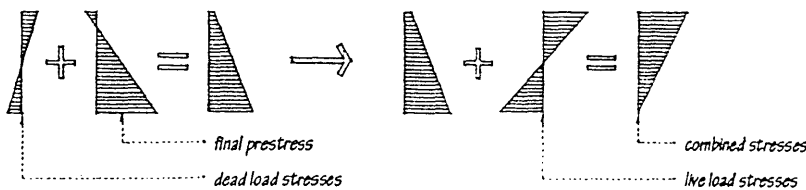
The internal stress that exists in a prestressed concrete member after all losses in prestress have occurred.

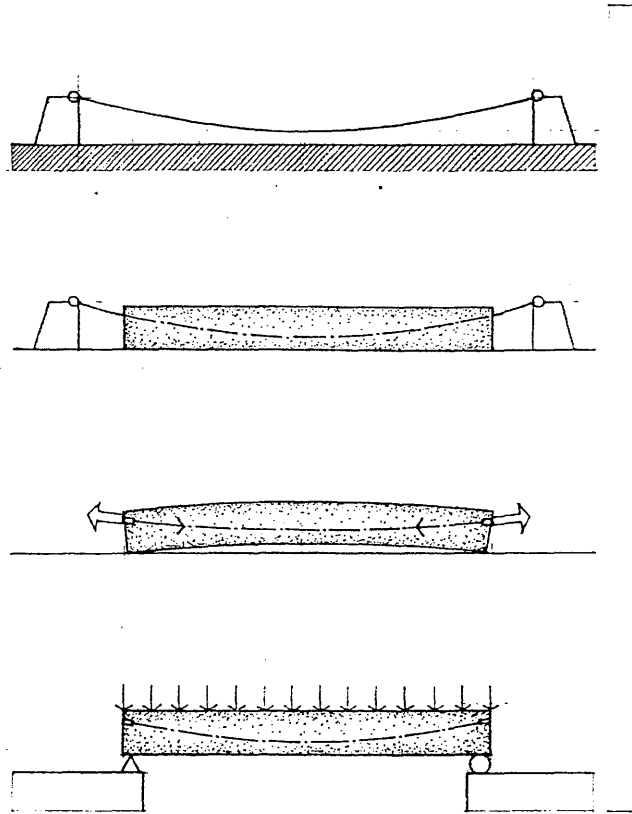
## effective prestress

The final prestress in a prestressed concrete member, including the effect of the weight of the member but excluding the effect of any superimposed load.

## partial prestressing

The prestressing of a concrete member to a level of stress such that nominal tensile stresses exist at design or service loads.





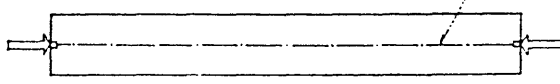
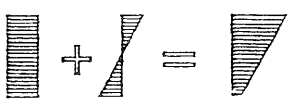
**posttension**  
To prestress a concrete member by tensioning the reinforcing tendons after the concrete has set. Unstressed tendons are placed in sheaths before concrete is cast in formwork around the tubes. After the concrete has cured, the tendons are clamped on one end and jacked against the concrete on the other end until the required force is developed. The tendons are then anchored on the jacking end and the jack removed.

**bonded posttensioning**  
Posttensioning in which the reinforcing tendons are bonded to the surrounding concrete by injecting grout into the annular spaces around the strands.

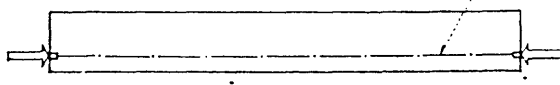
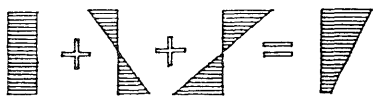
**unbonded posttensioning**  
Posttensioning in which the annular spaces around the reinforcing tendons are not grouted, allowing the tendons to move relative to the surrounding concrete.

**sheath**  
A tube for encasing tendons in a posttensioned member to prevent their bonding to the concrete during placement.

**pre-posttension**  
To prestress a concrete member by pretensioning some of the tendons and posttensioning others.

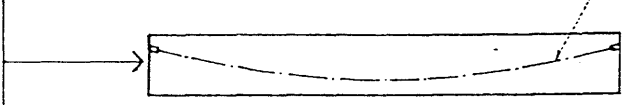


**concentric tendon**  
A tendon having a straight trajectory coincident with the centroidal axis of a prestressed concrete member. When tensioned, the tendon produces a uniformly distributed compressive stress across the section that counteracts the tensile stress from bending.

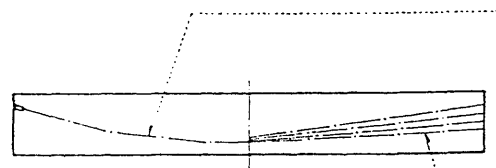


**eccentric tendon**  
A tendon having a straight trajectory not coincident with the centroidal axis of a prestressed concrete member. When tensioned, the tendon produces an eccentric prestressing force that reduces the compressive stress across the section to that produced by bending alone.

**load balancing**  
The concept of prestressing a concrete member with draped tendons, theoretically resulting in a state of zero deflection under a given loading condition.



**draped tendon**  
A posttensioning tendon having a parabolic trajectory that mirrors the moment diagram of a uniformly distributed gravity load. When tensioned, the tendon produces a variable eccentricity that responds to the variation in applied bending moment along the length of the member.



**depressed tendon**  
A pretensioning tendon that approximates the curve of a draped tendon with straightline segments, used in the pretensioning process since the prestressing force does not allow for draping the tendon.

**harped tendon**  
One of a series of depressed tendons having varying slopes.

# ROOF

The external upper covering of a building, including the frame for supporting the roofing.

## flat roof

A roof having no slope, or one with only a slight pitch so as to drain rainwater.

## pitched roof

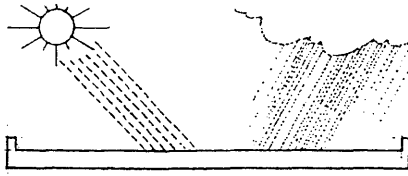
A roof having one or more slopes.

## gable roof

A roof sloping downward in two parts from a central ridge, so as to form a gable at each end.

## gable

The triangular portion of wall enclosing the end of a pitched roof from cornice or eaves to ridge.



## pitch

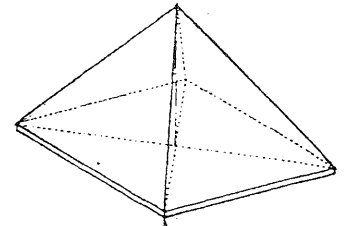
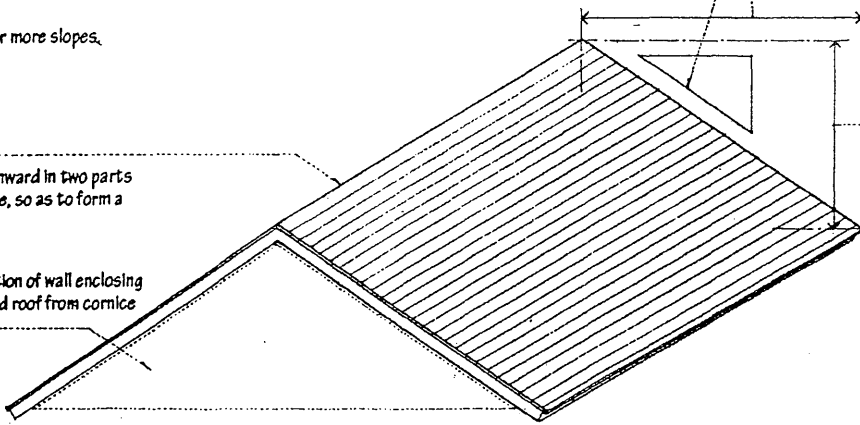
The slope of a roof, commonly expressed in inches of vertical rise per foot of horizontal run.

## rise

The measured height of a sloping roof from the eaves to the ridge.

## run

The horizontal distance from the eaves to the ridge of a sloping roof.

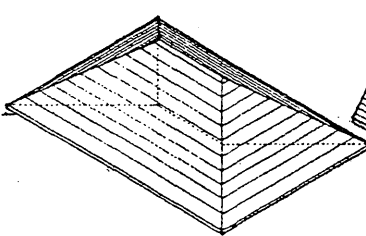


## pavilion roof

A pyramidal hip roof.

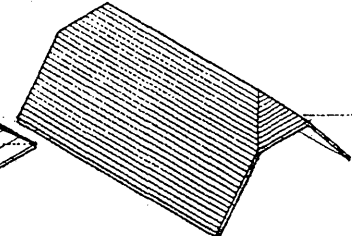
## hip roof

A roof having sloping ends and sides meeting at an inclined projecting angle. Also, hipped roof.



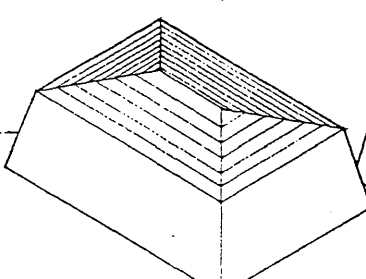
## hipped gable

A roof having a hipped end truncating a gable. Also called Jerkinhead, shreadhead.



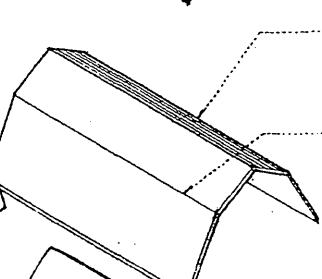
## curb roof

A roof divided on each side of the ridge into two or more slopes, as a gambrel or mansard.



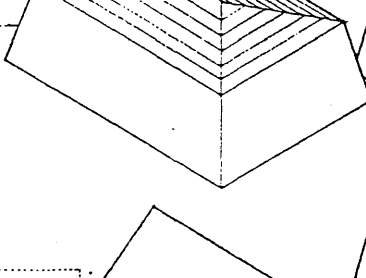
## gambrel roof

A ridged roof divided on each side into a shallower slope above a steeper one.



## mansard

A roof having on each side a steeper lower part and a shallower upper part. Also called mansard roof.

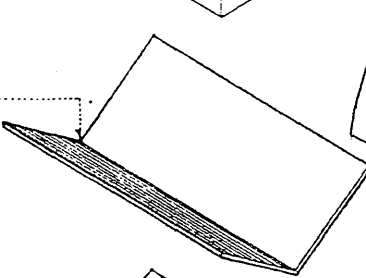


## curb

The arris between an upper and a lower slope on a gambrel or mansard roof.

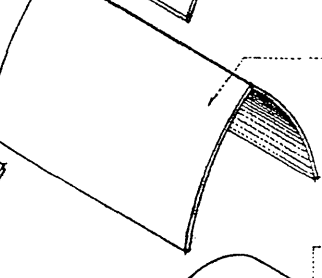
## butterfly roof

A roof having two slopes, each descending inward from the eaves.



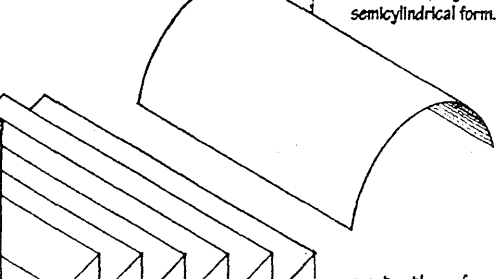
## rainbow roof

A gable roof in the form of a broad Gothic arch, with gently sloping convex surfaces.



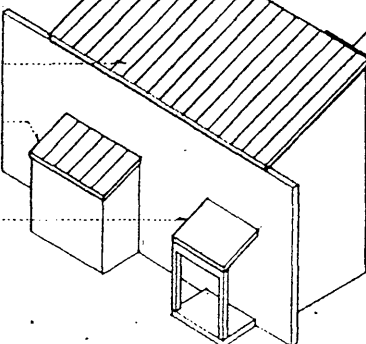
## barrel roof

A roof or ceiling having a semicylindrical form.



## shed roof

A roof having a single slope.



## lean-to

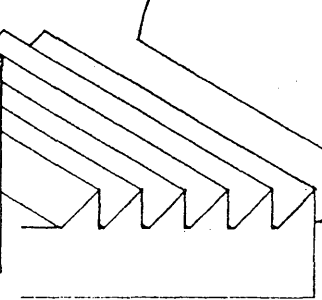
A shed roof with the higher end abutting a wall or larger building.

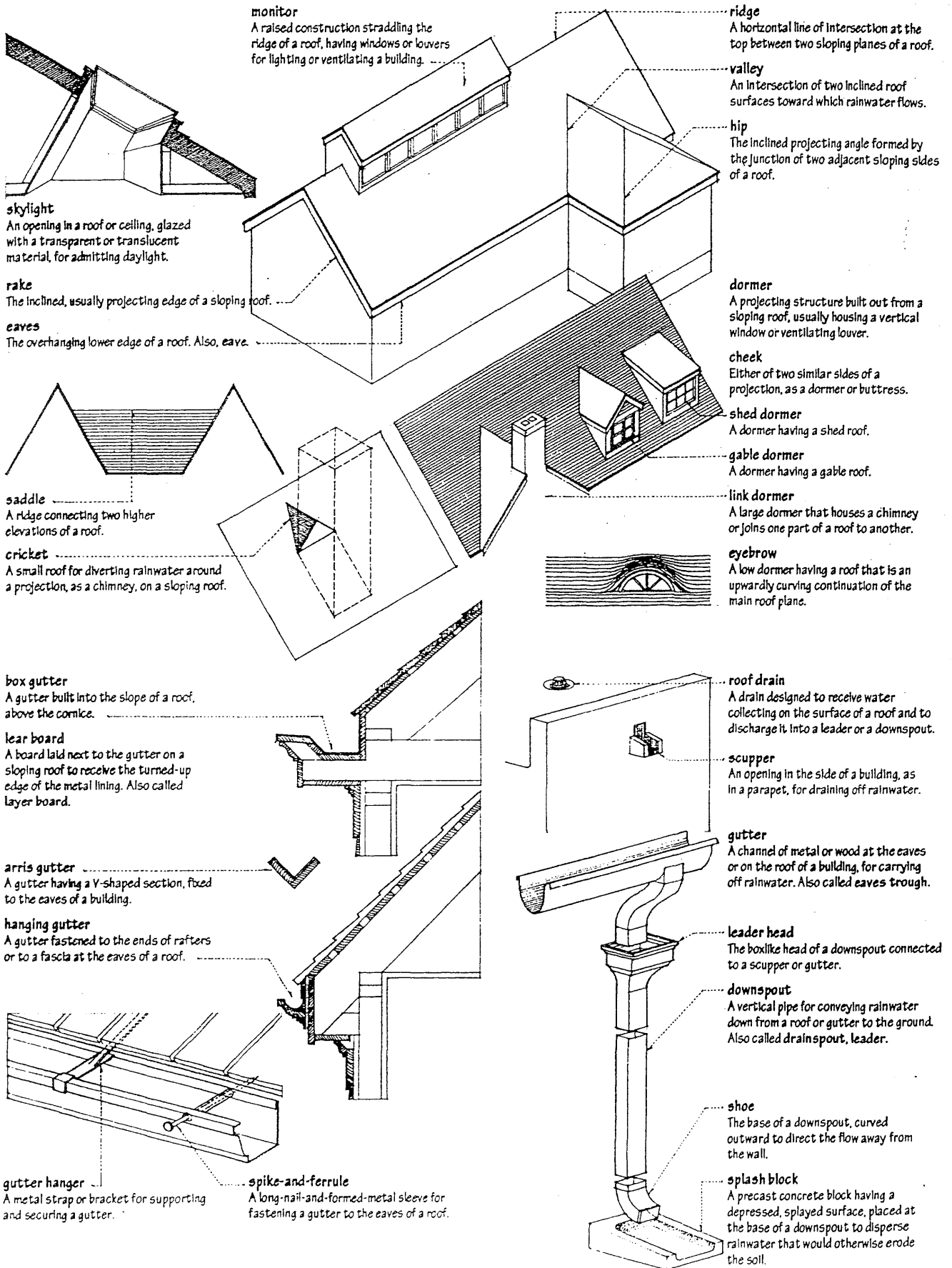
## penthouse

A shed roof projecting from a wall or the side of a building, as to shelter a door. Also called appentice, pent, pentice.

## sawtooth roof

A roof composed of a series of small parallel roofs of triangular cross section, usually asymmetrical with the shorter slope glazed.





**monitor**  
A raised construction straddling the ridge of a roof, having windows or louvers for lighting or ventilating a building.

**ridge**  
A horizontal line of intersection at the top between two sloping planes of a roof.

**skylight**  
An opening in a roof or ceiling, glazed with a transparent or translucent material, for admitting daylight.

**valley**  
An intersection of two inclined roof surfaces toward which rainwater flows.

**rake**  
The inclined, usually projecting edge of a sloping roof.

**hip**  
The inclined projecting angle formed by the junction of two adjacent sloping sides of a roof.

**eaves**  
The overhanging lower edge of a roof. Also, eave.

**dormer**  
A projecting structure built out from a sloping roof, usually housing a vertical window or ventilating louver.

**cheek**  
Either of two similar sides of a projection, as a dormer or buttress.

**shed dormer**  
A dormer having a shed roof.

**gable dormer**  
A dormer having a gable roof.

**link dormer**  
A large dormer that houses a chimney or joins one part of a roof to another.

**saddle**  
A ridge connecting two higher elevations of a roof.

**cricket**  
A small roof for diverting rainwater around a projection, as a chimney, on a sloping roof.

**eyebrow**  
A low dormer having a roof that is an upwardly curving continuation of the main roof plane.

**box gutter**  
A gutter built into the slope of a roof, above the cornice.

**lear board**  
A board laid next to the gutter on a sloping roof to receive the turned-up edge of the metal lining. Also called layer board.

**roof drain**  
A drain designed to receive water collecting on the surface of a roof and to discharge it into a leader or a downspout.

**scupper**  
An opening in the side of a building, as in a parapet, for draining off rainwater.

**aris gutter**  
A gutter having a Y-shaped section, fixed to the eaves of a building.

**hanging gutter**  
A gutter fastened to the ends of rafters or to a fascia at the eaves of a roof.

**gutter**  
A channel of metal or wood at the eaves or on the roof of a building, for carrying off rainwater. Also called eaves trough.

**leader head**  
The boxlike head of a downspout connected to a scupper or gutter.

**downspout**  
A vertical pipe for conveying rainwater down from a roof or gutter to the ground. Also called drainspout, leader.

**gutter hanger**  
A metal strap or bracket for supporting and securing a gutter.

**spike-and-ferrule**  
A long-nail-and-formed-metal sleeve for fastening a gutter to the eaves of a roof.

**shoe**  
The base of a downspout, curved outward to direct the flow away from the wall.

**splash block**  
A precast concrete block having a depressed, splayed surface, placed at the base of a downspout to disperse rainwater that would otherwise erode the soil.

# ROOF

## double roof

A roof in which longitudinal members, as a ridge beam and purlins, are used as intermediate supports for common rafters. Also called double-framed roof.

## king post

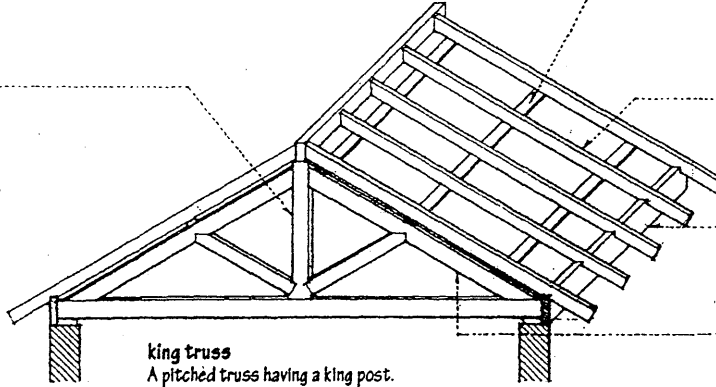
A vertical member from the apex to the bottom chord of a pitched truss.

## joggle post

A king post having notches or raised areas for receiving and supporting the feet of inclined struts. Also called joggle piece.

## joggle

An enlarged area of a post for supporting the foot of a strut or brace.



## purlin

A longitudinal member of a roof frame for supporting common rafters between the ridge and the eaves. Also, purline. Also called binding rafter.

## subpurlin

A light structural member for carrying roofing materials, supported by and running at right angles to purlins.

## common rafter

A rafter extending from a wallplate to a ridgeboard or ridgebeam and having no function other than to support sheathing and covering of a roof.

## pole plate

A beam perpendicular to the ends of tie beams in a trussed roof and supporting common rafters near their lower ends.

## principal rafter

A diagonal member of a roof principal, usually forming part of a truss and supporting the purlins on which common rafters rest.

## principal

A member in a frame structure upon which adjacent or similar members depend for support or reinforcement.

## auxiliary rafter

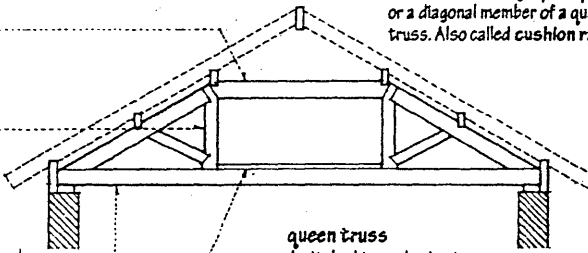
A rafter reinforcing a principal rafter or a diagonal member of a queen truss. Also called cushion rafter.

## straining piece

A horizontal tie beam uniting the tops of two queen posts. Also called straining beam.

## queen post

Either of the two vertical web members set at equal distances from the apex of a pitched truss.

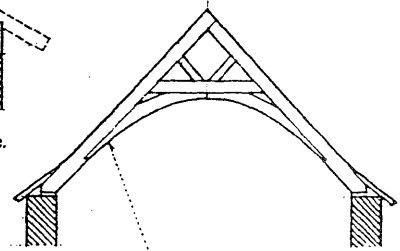


## tie beam

A horizontal timber for connecting two structural members to keep them from spreading apart, as a beam connecting the feet of two principal rafters in a roof truss.

## straining sill

A compression member lying along and dogged to the tie beam of a queen truss and separating the feet of the queen posts.



## arch brace

A curved brace, usually used in pairs to support a roof frame and give the effect of an arch.

## hammer post

A vertical timber set on the inner end of a hammer beam and braced to a collar beam above to support a purlin.

## hammer beam

One of pair of short horizontal members attached to the foot of a principal rafter at the level of the wall plate, used in place of a tie beam.

## hammer brace

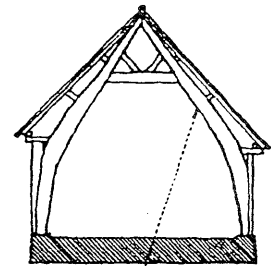
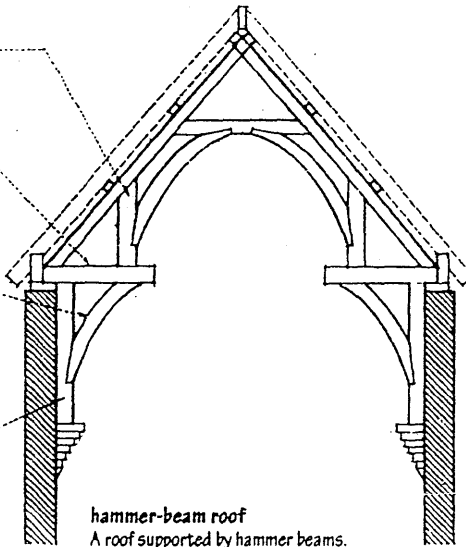
A bracket for supporting a hammer beam.

## bracket

A support projecting horizontally from a wall to bear the weight of a cantilever or to strengthen an angle.

## pendant post

A vertical timber supported at its lower end by a corbel and carrying at its upper end a hammer beam or tie beam.



## cruck

One of a pair of naturally curved timbers, forming one of several arched frames supporting the roof of an old English cottage or farm building.

**ridge beam**  
A beam for supporting the upper ends of rafters at the ridge of a roof.

**ridge board**  
A horizontal timber at the ridge of a roof, to which the upper ends of the rafters are fastened. Also called *ridgepole*, *ridgepiece*.

**roof framing**  
The act, process, or manner of constructing the structural frame of a roof.

**couple**  
A pair of rafters connected by a collar beam or tie beam. Also called *couple-close*.

**collar beam**  
A horizontal timber uniting two opposing common rafters at a point below the ridge, usually in the upper half of the rafter length. Also called *collar tie*.

**rafter**  
Any of a series of small, parallel beams for supporting the sheathing and covering of a pitched roof.

**ceiling joist**  
A joist for carrying the finish ceiling of a room.

**knee wall**  
A short wall supporting rafters at some intermediate position along their length.

**bird's mouth**  
A right-angled notch cut on the underside of a rafter to fit over a longitudinal member, as a wall plate.

**seat cut**  
A horizontal cut at the lower end of a rafter that allows it to rest on and be connected to a wall plate. Also called *foot cut*, *plate cut*.

**jack**  
Having a length or height less than that of most of the others in a framed structure, as a jack rafter or jack truss.

**jack rafter**  
Any rafter that is shorter than the full length of the roof slope, as one meeting a hip or a valley.

**valley jack**  
A jack rafter extending from a valley rafter to a ridge.

**valley rafter**  
A rafter connecting the ridge to the wall plate along a valley.

**cripple jack**  
A rafter joining a hip to a valley. Also called *double jack rafter*.

**hip jack**  
A jack rafter extending from a wall plate to a hip rafter.

**hip rafter**  
A rafter forming the junction of the sloping sides of a hip roof.

**dragon beam**  
A short beam receiving and holding the foot of a hip rafter to counteract its thrust. Also called *dragon piece*.

**dragon tie**  
An angle brace for supporting one end of a dragon beam.

**top cut**  
A plumb cut at the upper end of a rafter where it butts against a ridgeboard.

**plumb**  
Vertical or perpendicular in direction.

**stepping off**  
A method of determining the length of a rafter with a framing square, by marking an increment of angular length for each foot of horizontal run.

**lookout**  
A relatively short bracket or cantilever for supporting the overhang of a roof. Also called *tailpiece*.

**fly rafter**  
Either of the end rafters in the part of a gable roof that projects beyond the gable wall.

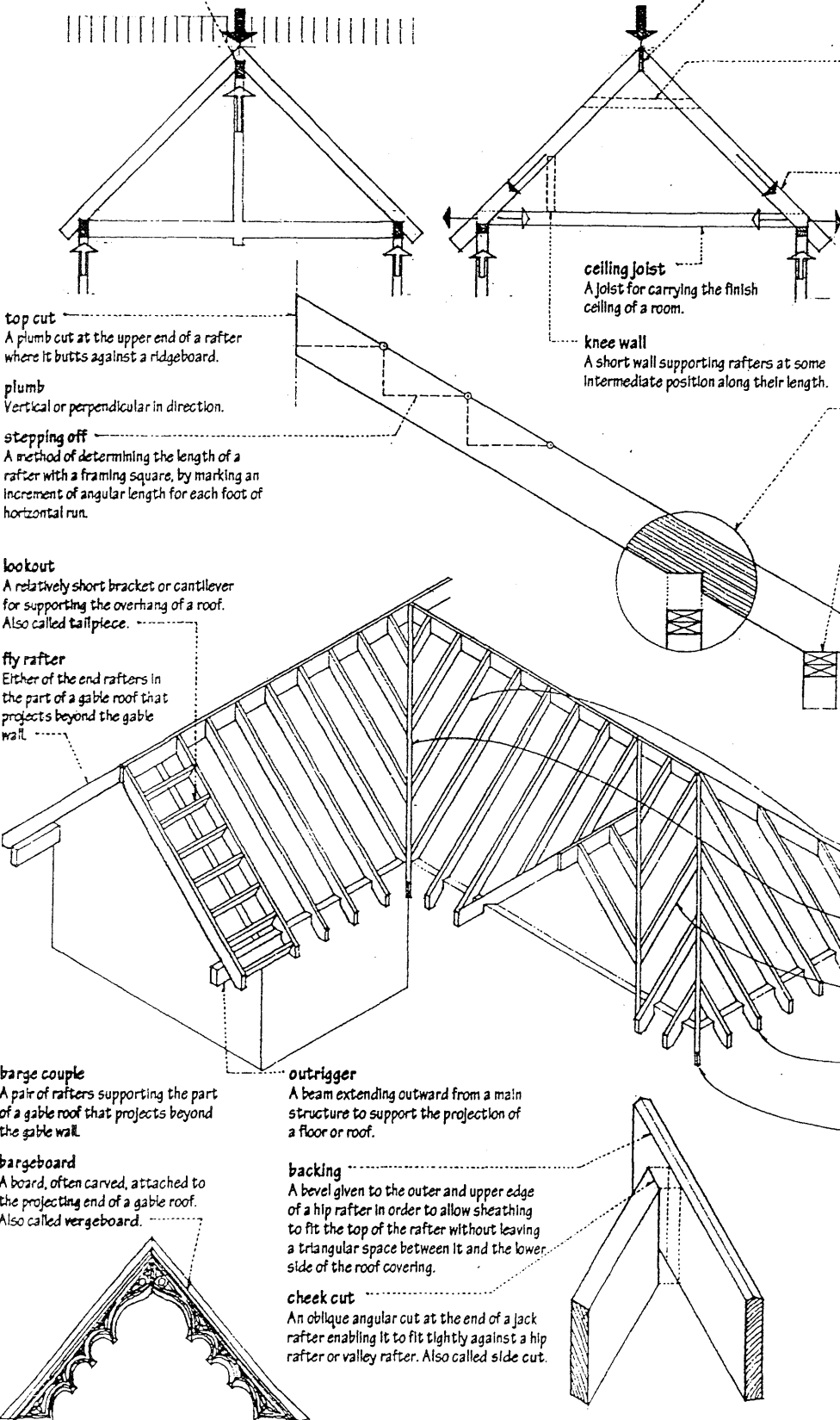
**barge couple**  
A pair of rafters supporting the part of a gable roof that projects beyond the gable wall.

**bargeboard**  
A board, often carved, attached to the projecting end of a gable roof. Also called *vergeboard*.

**outrigger**  
A beam extending outward from a main structure to support the projection of a floor or roof.

**backing**  
A bevel given to the outer and upper edge of a hip rafter in order to allow sheathing to fit the top of the rafter without leaving a triangular space between it and the lower side of the roof covering.

**cheek cut**  
An oblique angular cut at the end of a jack rafter enabling it to fit tightly against a hip rafter or valley rafter. Also called *side cut*.



# ROOF

## roofing

Any of various water-resistant materials, as shingles, slates, or tiles, laid on a roof to shed or drain rainwater.

## shingle

A thin, usually oblong piece of wood, asphaltic material, slate, metal, or concrete, laid in overlapping rows to cover the roof and walls of buildings.

## imbrication

The overlapping of shingles or roofing tiles with break joints to form a weathertight covering.

## break joints

The arranging of building units, as masonry, shingles, or siding, to ensure that vertical joints are not continuous in adjacent courses. Also called *staggered joints*.

## common lap

A method of laying shingles by offsetting alternate courses one-half the width of a shingle.

## to lap

The distance by which a shingle, slate, or roofing tile overlaps another in the course immediately below it.

## exposure

The portion of the length of a shingle, slate, or roofing tile left exposed to the weather when laid in place. Also called *gauge*, *margin*.

## headlap

The distance by which a shingle, slate, or roofing tile overlaps another in the second course below it.

## ridge cap

A course or layer of roofing material covering the ridge of a roof.

## ridge course

The top course of shingles, slates, or roofing tiles next to a ridge, cut to the required length.

## ribbon course

One of the alternate courses of shingles or slate laid with shorter or longer exposure.

## staggered course

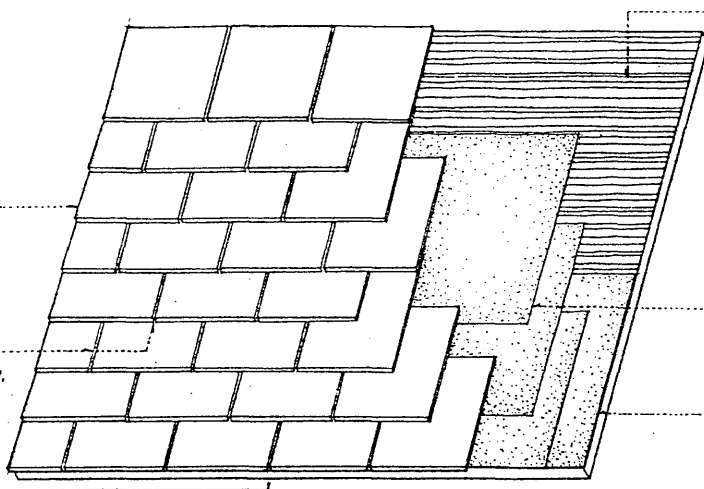
A course of shingles laid with the butts slightly above or below the one adjacent.

## doubling course

A double layer of shingles or tiles laid at the foot of a roof slope or a vertical section of shingling.

## starting course

The first course of shingles, slates, or tiles along the eaves of a roof before the first regular course is laid.



## sheathing

Boards or structural panels, as plywood, fastened to the frame of a wall or roof as a base for cladding or roofing.

## panel clip

An H-shaped metal device for joining sheets of plywood roof sheathing at unsupported joints.



## underlayment

A weather-resistant material, as roofing felt, for covering and protecting a roof deck before shingles are applied.

## eaves flashing

An additional layer of underlayment cemented to a roof deck to prevent melting ice and snow from backing up under the roofing along the eaves.

## ice dam

A buildup of snow and ice along the eave of a sloping roof.

## Dutch lap

A method of laying shingles or slates by lapping each shingle over one to the side and one below.

## sidelap

The distance by which a shingle, slate, or roofing tile overlaps an adjacent one along its side edge. Also called *endlap*.

## coverage

The amount of weather protection provided by the overlapping of shingles or slates.

## square

A unit for measuring roofing materials, equal to 100 sq. ft. (9.3 sq. m) of coverage.

## asphalt shingle

A composition shingle having an asphalt-impregnated felt base, surfaced on the weather side with colored mineral granules embedded in a hot asphaltic coating.

## fiberglass shingle

A composition shingle having an inorganic fiberglass base, saturated with asphalt and surfaced on the weather side with colored ceramic granules.

## closed valley

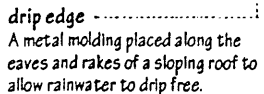
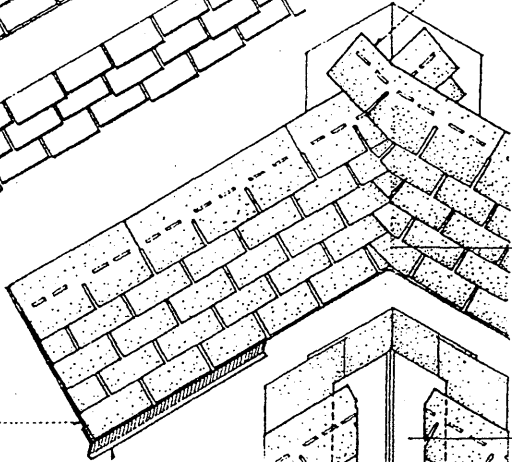
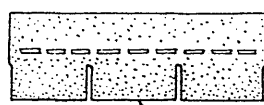
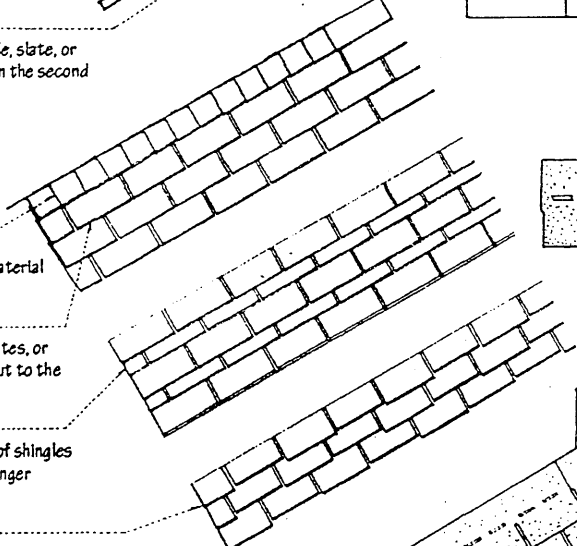
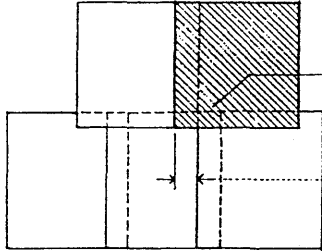
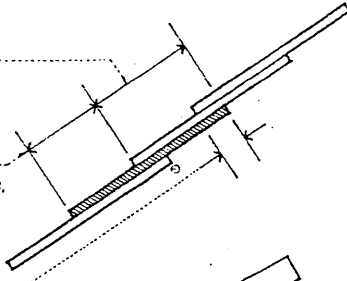
A valley formed by overlapping successive courses of shingles in alternate directions. Also called *laced valley*, *woven valley*.

## open valley

A valley at which shingles or slates are not laid to the intersection, exposing a lining of sheet metal or roll roofing.

## valley flashing

A wide strip of sheet metal or roofing felt for lining the valley of a roof.





**blue label**  
A premium grade of red cedar shingle of clear, edge-grained heartwood.

**red label**  
An intermediate grade of red cedar shingle having a limited amount of flat grain and sapwood.

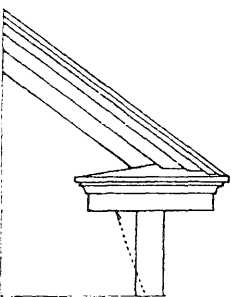
**black label**  
A utility grade of red cedar shingle.

**undercourse**  
A row of wood shingles laid along the rake of a sloping roof with the butts projecting outward to give an inward slope to the surface shingles. Also called undercloak.

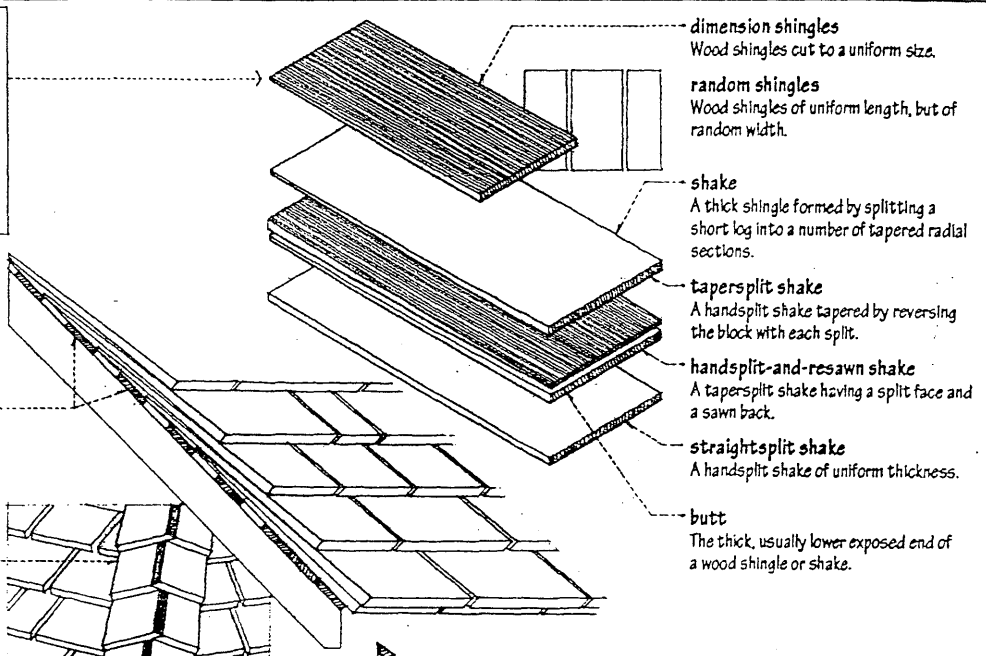
**spaced sheathing**  
Roofing boards laid some distance apart to provide ventilation for wood shingles and shakes. Also called open boarding, skip sheathing.

**Boston hip**  
The weaving of shingles at the hip or ridge of a roof. Also called Boston ridge.

**weaving**  
A method of laying shingles on adjoining surfaces of a roof or wall so that shingles on each face lap each other alternately.



**cornice return**  
The continuation of a cornice around the gable end of a house.



**dimension shingles**  
Wood shingles cut to a uniform size.

**random shingles**  
Wood shingles of uniform length, but of random width.

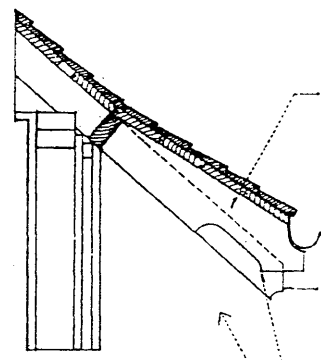
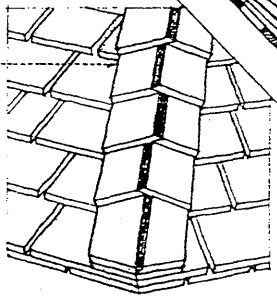
**shake**  
A thick shingle formed by splitting a short log into a number of tapered radial sections.

**tapersplit shake**  
A handsplit shake tapered by reversing the block with each split.

**handsplit-and-resawn shake**  
A tapersplit shake having a split face and a sawn back.

**straightsplit shake**  
A handsplit shake of uniform thickness.

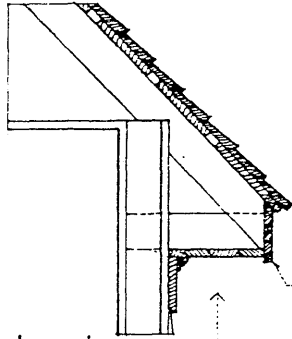
**butt**  
The thick, usually lower exposed end of a wood shingle or shake.



**sprocket**  
A strip of wood fixed to each rafter at the eaves in order to extend a sloping roof with a flatter pitch. Also called cocking piece.

**rafter tail**  
The lower, sometimes exposed, end of a rafter that overhangs a wall.

**tail cut**  
A sometimes ornamental cut at the lower end of a rafter tail.



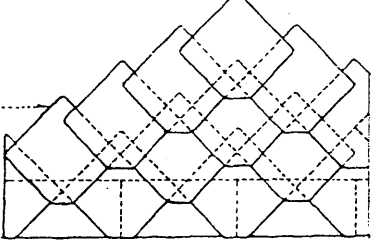
**box cornice**  
A slightly projecting, hollow cornice of boards and moldings, nailed to rafters and lockouts. Also called closed cornice.

**fascia**  
Any broad, flat, horizontal surface, as the outer edge of a cornice or roof.

**fascia board**  
A wide board set vertically to cover the lower ends of rafters or the joint between the top of a wall and the projecting eaves.

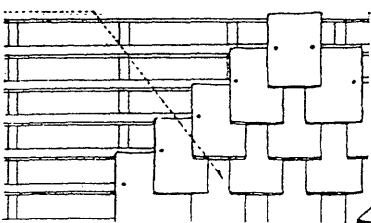
**open cornice**  
An eaves overhang exposing the ends of rafters and the underside of the roof sheathing. Also called open eaves.

**diagonal slating**  
A method of laying roofing slates with the diagonal of each tile running horizontally. Also called drop-point slating.

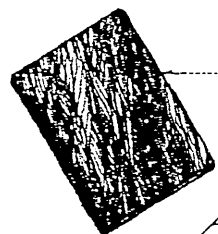


**honeycomb slating**  
Diagonal slating in which the tails are cut from the roofing slates.

**open slating**  
A method of laying roofing slates with spaces between adjacent tiles in a course. Also called spaced slating.

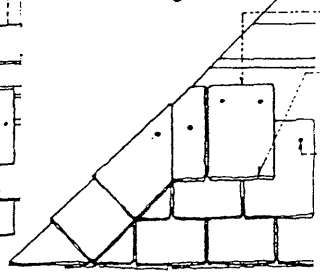


**diminishing course**  
One of a number of courses of roofing slates that diminish in exposure, and sometimes width, from the eaves to the ridge.



**sized slates**  
Roofing slates of uniform width.

**random slates**  
Roofing slates of varying width, often laid in diminishing courses. Also called rustic slates.



**head**  
The upper end of a roofing slate.

**tail**  
The lower, exposed portion of a roofing slate.

**slating nail**  
A copper nail having a large, flat head and a medium-diamond-shaped point, used esp. for fixing slates.

# ROOF

## roofing tile

Any of various clay or concrete tiles for covering a roof.

## field tile

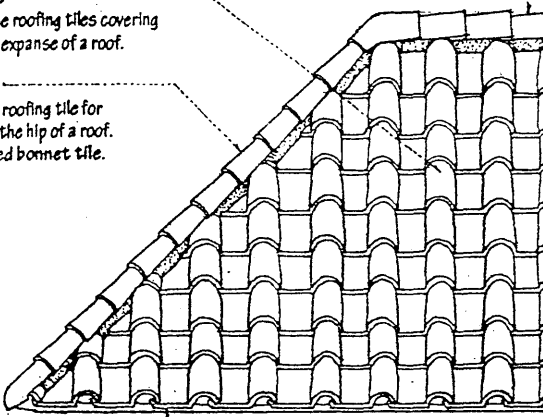
One of the roofing tiles covering the main expanse of a roof.

## hip tile

A convex roofing tile for covering the hip of a roof. Also called bonnet tile.

## ridge tile

A convex, sometimes decorated roofing tile for covering the ridge of a roof. Also called crown tile.



## eaves course

A first course of shingles, slates, or tiles on a roof.

## barge course

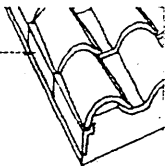
A row of slates or tiles placed on and projecting over the raking edges of a gable.

## rake tile

A roofing tile formed to cover the rake of a sloping roof.

## arris tile

An L-shaped roofing tile for covering the ridge, hip, or rake of a roof. Also called angle tile.

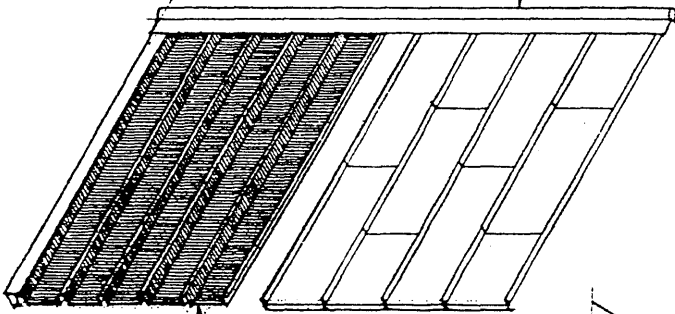


## oil-canning

The slight waviness of a sheet metal surface.

## ridge roll

A rounded cap for covering the ridge of a roof.



## corrugated roofing

A roof covering of corrugated sheets of galvanized iron, coated steel, aluminum, fiberglass, or reinforced plastic.

## copper roofing

A roof covering of copper sheets, joined by standing seams.

## tin roofing

A roof covering of flexible tinplate or terneplate.

## Monel metal

Trademark for a brand of an alloy consisting mainly of nickel and copper.

## hold-down clip

A metal clip for securing lengths of sheet metal.

## overcloak

The part of a sheet of metal roofing that laps over a sheet beneath it at a drip or seam.

## undercloak

The lower sheet of metal roofing at a drip or seam.

## cleat

A strip of metal or wood attached to a surface to restrain or support an element or member.

## tile tie

A twisted wire tie extending from the eaves to the ridge of a roof, to which roofing tiles are secured.

## mission tile

A tapered, semicylindrical roofing tile laid convex side up to overlap flanking, similar tiles laid concave side up. Also called Spanish tile.

## imbrex

A tapered, semicylindrical roofing tile laid convex side up.

## tegula

A tapered, semicylindrical roofing tile laid concave side up.

## pantile

A roofing tile having an S-shaped cross section, laid so the downturn of one overlaps the upturn of the next in the same course.

## pan-and-roll tiling

A system of roofing tiles consisting of tapered, semicylindrical tiles overlapping the flanges of flat undertiles in the same course.

## interlocking tile

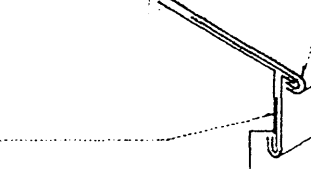
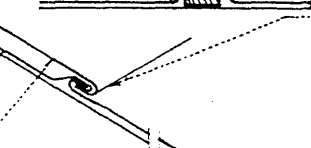
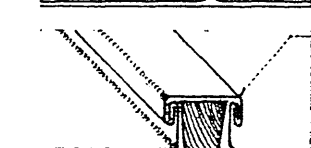
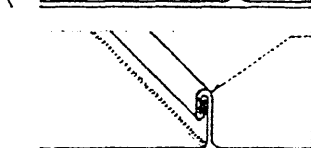
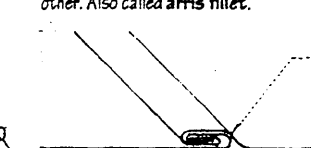
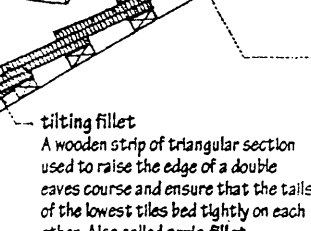
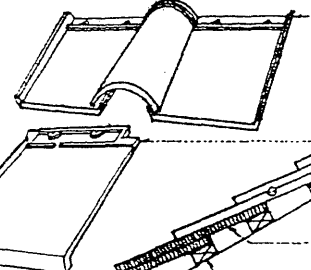
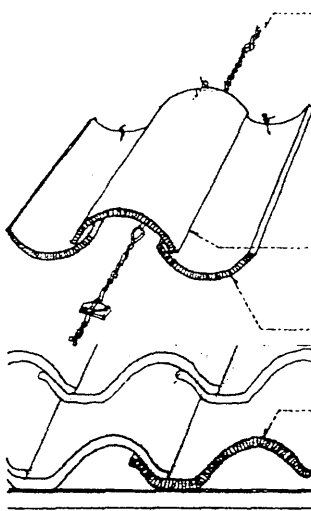
A flat, rectangular roofing tile having a groove along one edge that fits over a flange in the next tile in the same course.

## shingle tile

A flat, rectangular roofing tile laid in an overlapping pattern.

## batten

A horizontal wood strip on which roofing tiles or slates are hung.



## tilting fillet

A wooden strip of triangular section used to raise the edge of a double eaves course and ensure that the tails of the lowest tiles bed tightly on each other. Also called arris fillet.

## lock seam

A joint between two pieces of sheet metal, made by folding up the adjoining edges against each other, folding them over, and flattening the interlock.

## standing seam

A joint between two pieces of sheet metal, made by folding up the adjoining edges against each other, then folding their upper portion over in the same direction a number of times.

## batten seam

A joint between two pieces of sheet metal, made by turning up the adjoining edges against a batten and locking them in place with a metal strip placed over the batten.

## roll seam

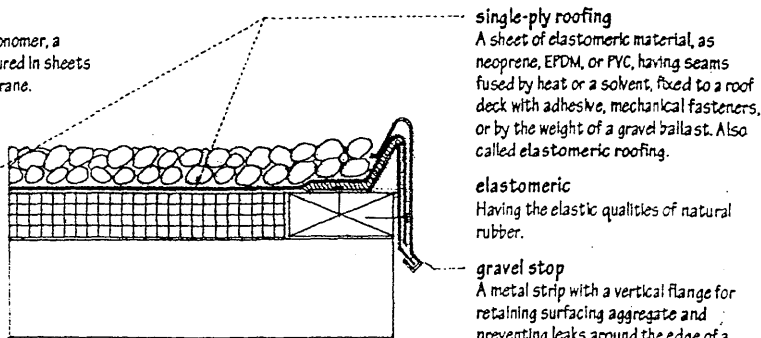
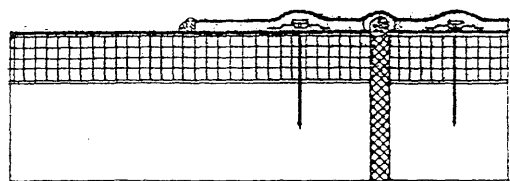
A joint between two pieces of sheet metal in the direction of fall of a curved or sloping roof, made by turning up the adjoining edges against each other, then bending them around to form a cylindrical roll.

## bead

An edge of sheet metal stiffened by bending and flattening a narrow strip or rolling the edge into a tube shape.

**Hypalon**  
Trademark for a brand of chlorinated polyethylene.

**EPDM**  
Ethylene propylene diene monomer, a synthetic rubber manufactured in sheets and used as a roofing membrane.

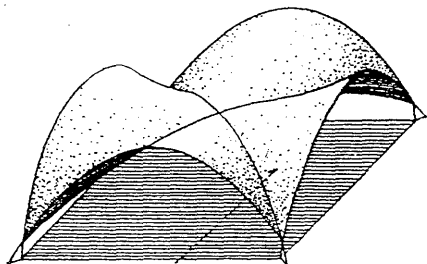


**single-ply roofing**  
A sheet of elastomeric material, as neoprene, EPDM, or PVC, having seams fused by heat or a solvent, fixed to a roof deck with adhesive, mechanical fasteners, or by the weight of a gravel ballast. Also called elastomeric roofing.

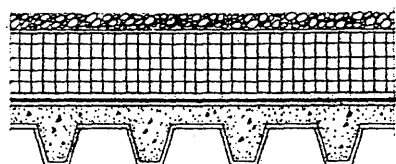
**elastomeric**  
Having the elastic qualities of natural rubber.

**gravel stop**  
A metal strip with a vertical flange for retaining surfacing aggregate and preventing leaks around the edge of a built-up roof.

**protected membrane roof**  
A single-ply roofing membrane protected from sunlight and extremes of temperature by a layer of rigid board insulation and an additional layer of gravel ballast.

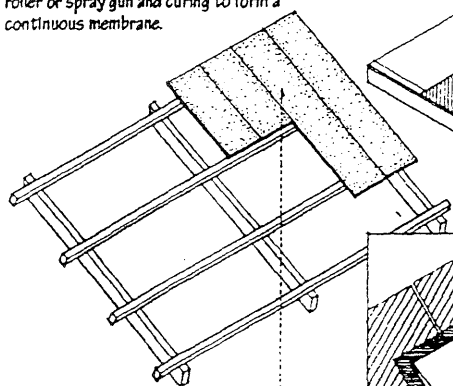


**fluid-applied roofing**  
A continuous covering for roofs of complex geometry, consisting of an elastomeric material, as neoprene, Hypalon, or butyl rubber, applied in multiple coats with a roller or spray gun and curing to form a continuous membrane.

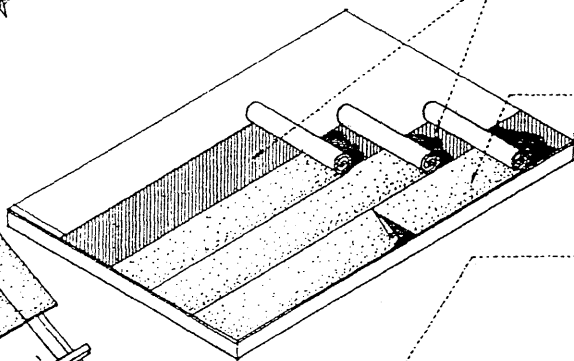


**selvage**  
The edge of a sheet of roll roofing that is free of granules and most of the asphalt coating so as to provide a better bond with the lap of the next sheet.

**roll roofing**  
A roofing material consisting of felt saturated with asphalt and surfaced on the weather side with a harder asphalt mixed with mineral or glass fibers, and a covering of mineral granules.



**structural insulating roof deck**  
A cementitious insulating board of lightweight aggregate or wood fibers bonded under pressure with portland cement, having a factory-finished underside for use on roofs with exposed beams.



**bitumen**  
Any of various mixtures of hydrocarbons occurring naturally or distilled from coal or petroleum, as asphalt or coal tar, used for surfacing roads, waterproofing, and roofing. Before application, the semisolid matter must be dissolved in a solvent, emulsified, or heated to a liquid state.

**asphalt**  
A brownish-black mixture of bitumens obtained from native deposits or as a petroleum by-product, used for paving, waterproofing, and roofing.

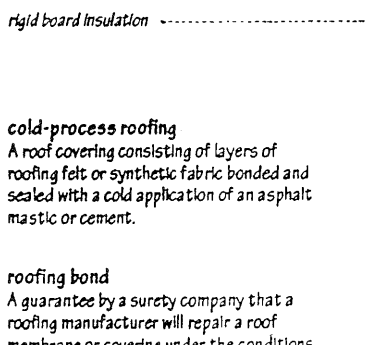
**coal tar**  
A viscous, black liquid formed during the distillation of coal, used for paints, waterproofing, and roofing.

**wear course**  
A layer of gravel serving to protect a roofing membrane from mechanical abrasion and uplifting wind forces.

**cap sheet**  
A sheet of coated, mineral-surfaced felt, used as the top ply in a built-up roof.

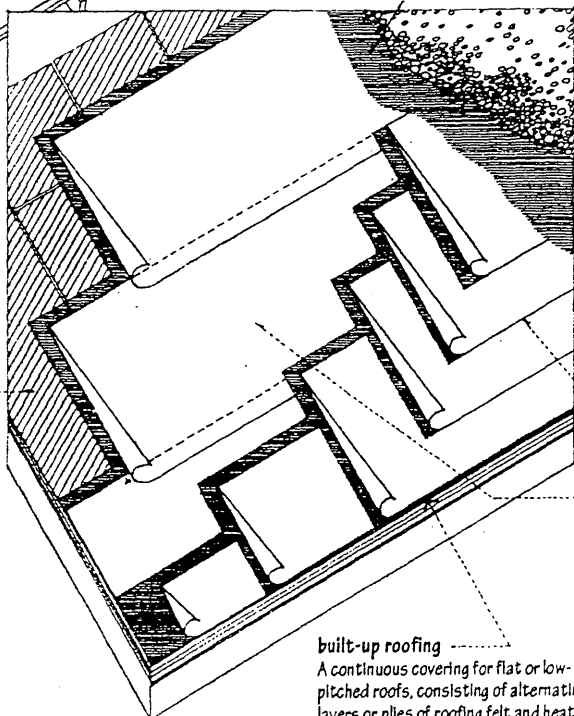
**base sheet**  
A felt impregnated with asphalt or coal tar for use as the first ply in the laying of a built-up roof.

**roofing felt**  
A matted, fibrous material impregnated with a bituminous material for increased toughness and resistance to weather. Also called roofing paper.



**cold-process roofing**  
A roof covering consisting of layers of roofing felt or synthetic fabric bonded and sealed with a cold application of an asphalt mastic or cement.

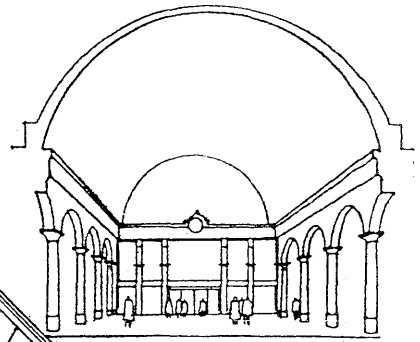
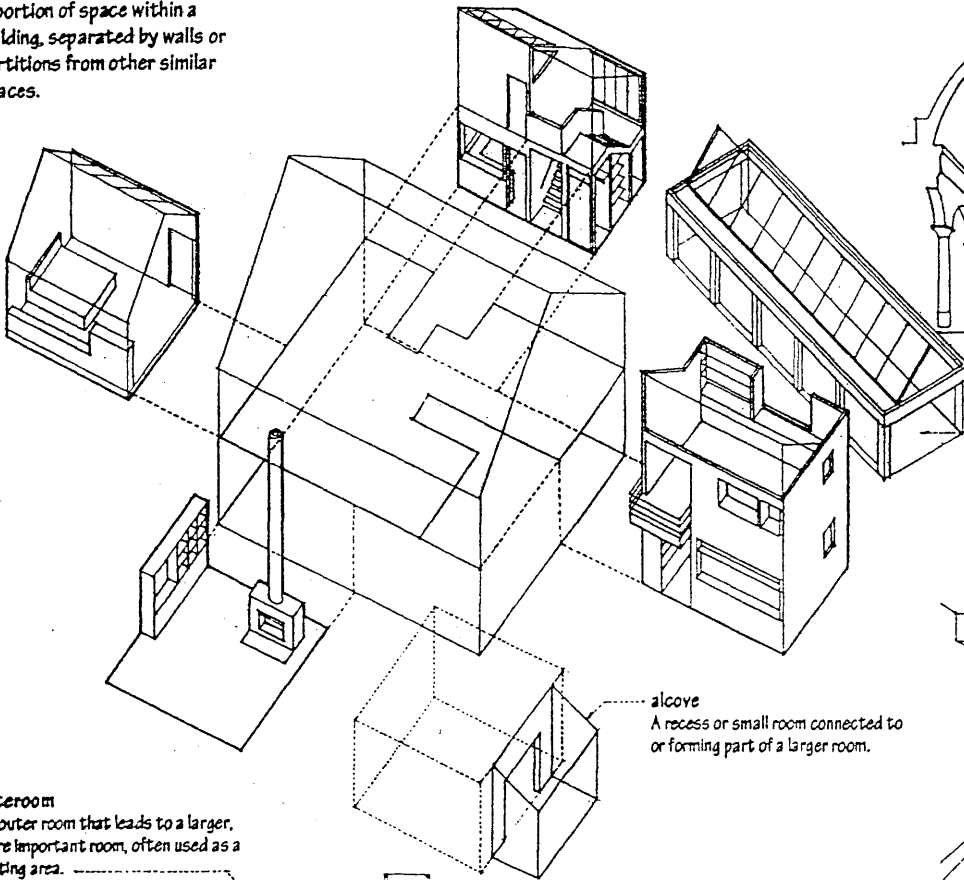
**roofing bond**  
A guarantee by a surety company that a roofing manufacturer will repair a roof membrane or covering under the conditions listed in the bonding contract.



**built-up roofing**  
A continuous covering for flat or low-pitched roofs, consisting of alternating layers or plies of roofing felt and heated bitumen, surfaced with a cap sheet or a layer of gravel or slag in a heavy coat embedded in bitumen.

# ROOM

A portion of space within a building, separated by walls or partitions from other similar spaces.



**hall**  
A large room or building for public gatherings or entertainment.

**gallery**  
A long, relatively narrow room or hall, esp. one for public use and having architectural importance through its scale or decorative treatment.

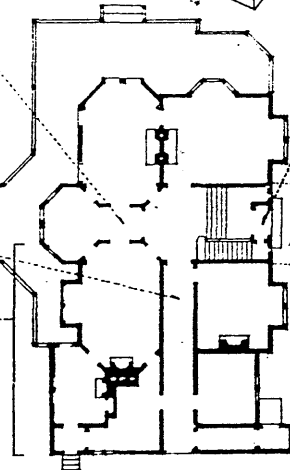
**anteroom**  
An outer room that leads to a larger, more important room, often used as a waiting area.

**hallway**  
A corridor or passageway in a house, hotel, or other building. Also called hall.

**corridor**  
A narrow passageway or gallery connecting parts of a building, esp. one into which several rooms or apartments open.

**suite**  
A connected series or group of rooms arranged to be used together.

**closed plan**  
A floor plan consisting of fully enclosed spaces or distinct rooms linked by doorways.

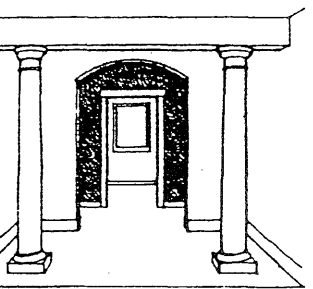
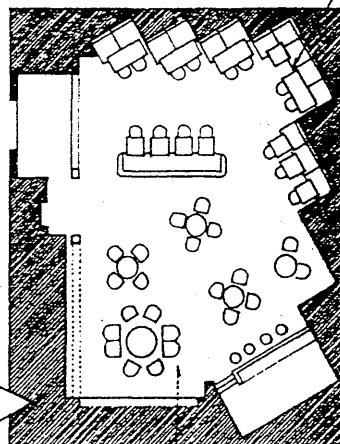


**alcove**  
A recess or small room connected to or forming part of a larger room.

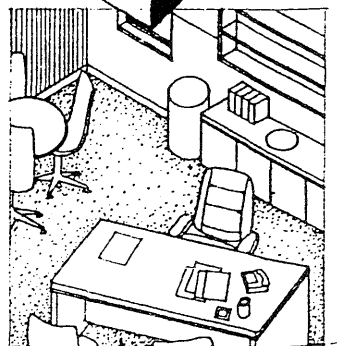
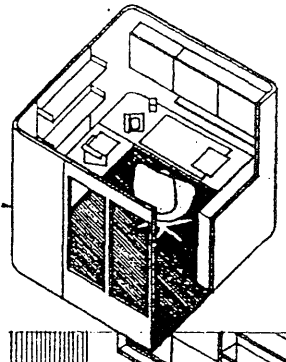
**vestibule**  
A small entrance hall between the outer door and the interior of a house or building.

**functional grouping**  
A set of furniture pieces arranged according to function and use.

**tight fit**  
A close, often compact correspondence between functional groupings and the form or structure of the enclosing space.

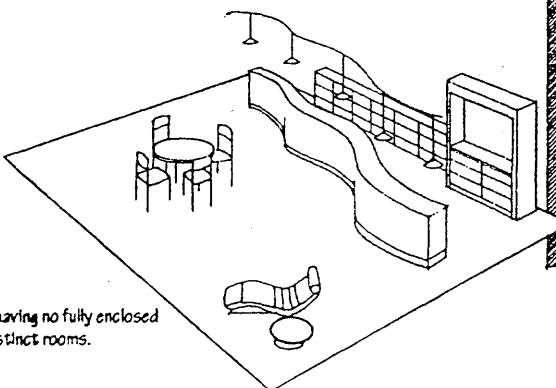


**enfilade**  
An axial arrangement of doorways connecting a series of rooms so as to provide a vista down the entire length of the suite.

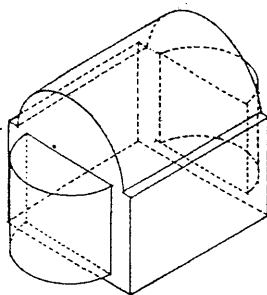
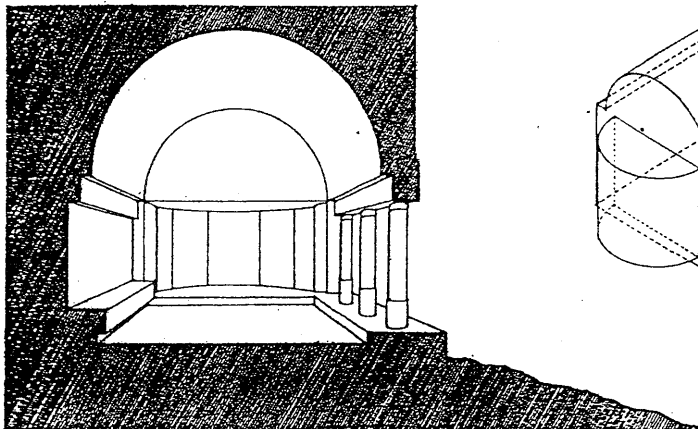


**loose fit**  
A free and unrestrained arrangement of furniture groupings that does not necessarily correspond to the form or structure of the surrounding space.

**open plan**  
A floor plan having no fully enclosed spaces or distinct rooms.

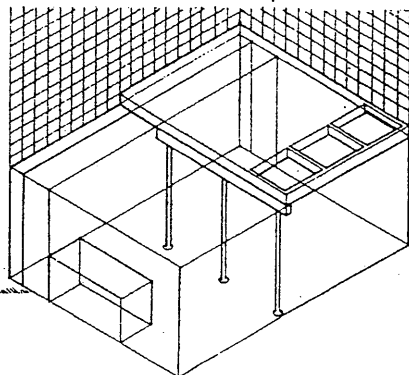


**mass**  
The physical volume or bulk of a solid body.

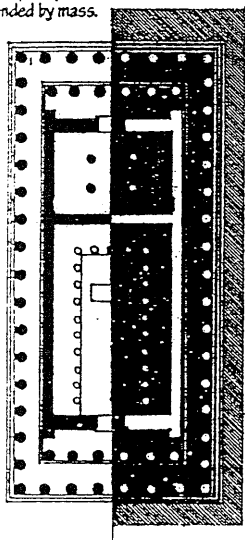


**space**  
The three-dimensional field in which objects and events occur and have relative position and direction, esp. a portion of that field set apart in a given instance or for a particular purpose.

**Euclidean space**  
Ordinary two- or three-dimensional space in which Euclid's definitions and axioms apply. Also called Cartesian space.



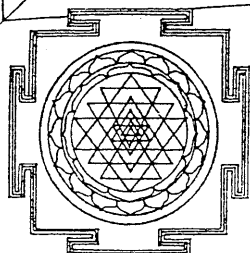
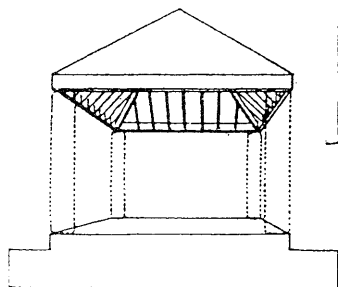
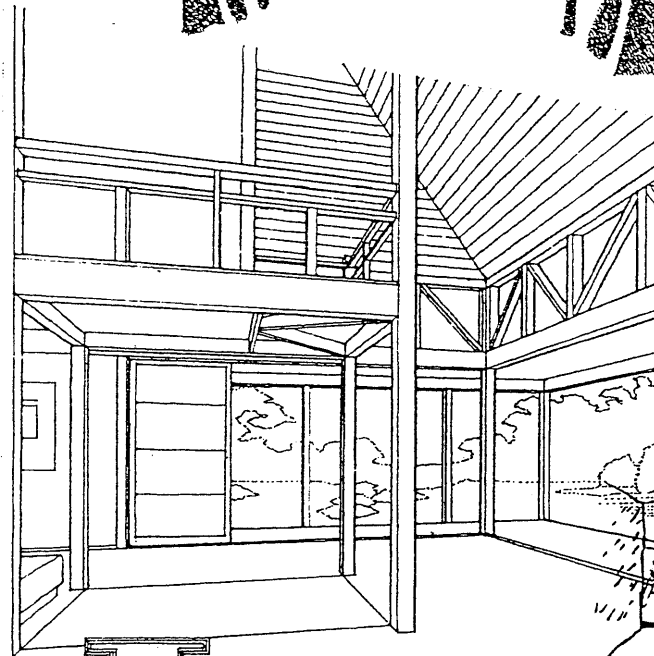
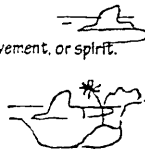
**void**  
An empty space contained within or bounded by mass.



**place**  
A physical environment having particular characteristics or used for a particular purpose.

**ambiance**  
The mood, character, or atmosphere of an environment or milieu. Also, *ambiance*.

**animated**  
Full of life, activity, movement, or spirit.



**refuge**  
A place affording shelter, protection, or safety from danger or distress.

**repose**  
A place of rest and tranquility.

**center**  
A point or place upon which interest, activity, or emotion focuses.

**focus**  
A central point of attraction, attention, or activity.

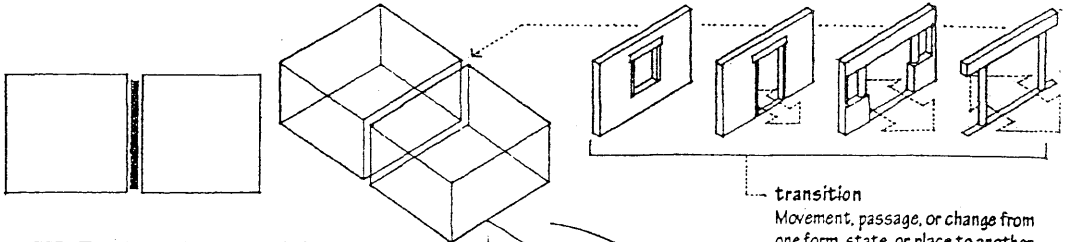
**outlook**  
A view from a particular place, or the place offering a view.

**prospect**  
An outlook over a region or in a particular direction, or the place that commands such a view.

# ROOM

## adjacent spaces

Two spaces abutting or contiguous with each other, esp. when having a common boundary or border.

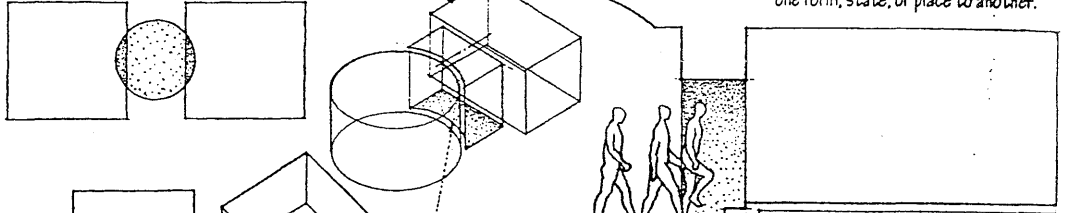


## transition

Movement, passage, or change from one form, state, or place to another.

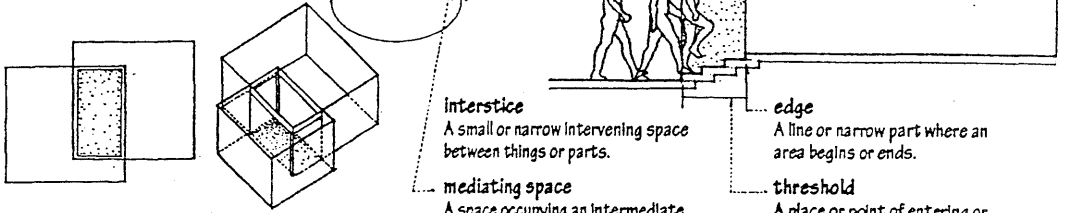
## linked spaces

Two spaces joined or connected by a third intervening space.



## interlocking spaces

Two spaces interwoven or fit into each other so as to form a zone or field of shared space.



## interstice

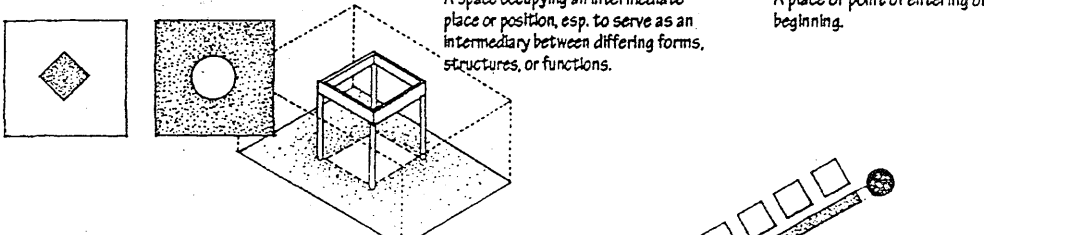
A small or narrow intervening space between things or parts.

## edge

A line or narrow part where an area begins or ends.

## embedded space

A space enveloped or incorporated as an essential part of a larger space.



## mediating space

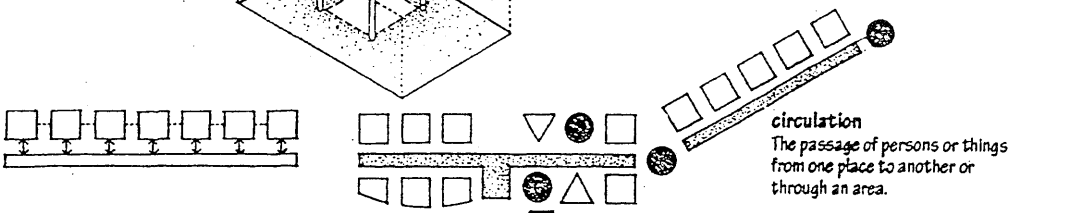
A space occupying an intermediate place or position, esp. to serve as an intermediary between differing forms, structures, or functions.

## threshold

A place or point of entering or beginning.

## linear organization

Spaces extended, arranged, or linked along a line, path, or gallery.

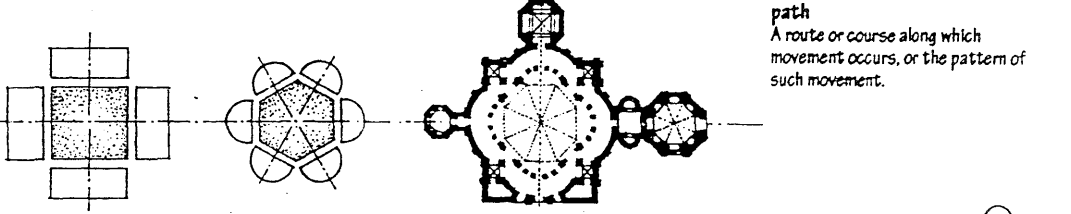


## circulation

The passage of persons or things from one place to another or through an area.

## centralized organization

Spaces gathered about or coming together at a large or dominant central space.

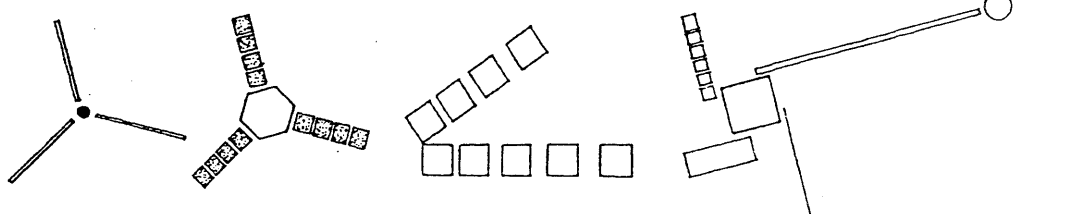


## path

A route or course along which movement occurs, or the pattern of such movement.

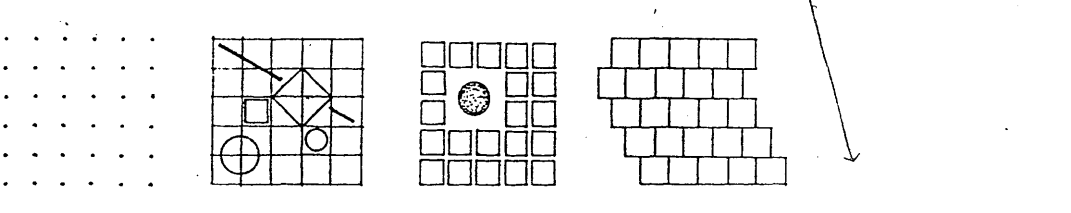
## radial organization

Spaces arranged like radii or rays from a central space or core.



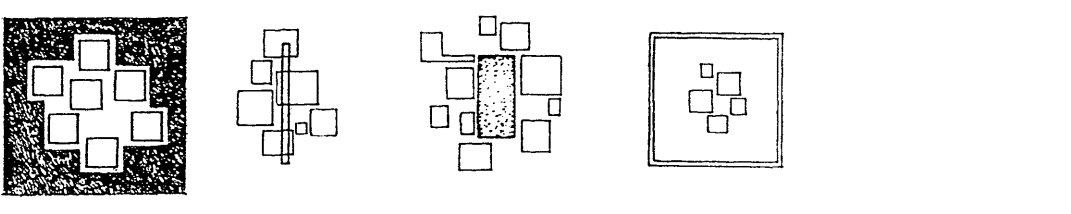
## grid organization

Spaces organized with reference to a rectangular system of lines and coordinates.



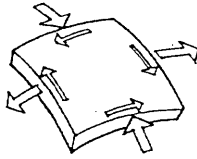
## clustered organization

Spaces grouped, collected, or gathered closely together and related by proximity rather than geometry.



**membrane stresses**

The compressive, tensile, and shear stresses acting in the plane of the surface of a shell structure. A shell can sustain relatively large forces if uniformly applied. Because of its thinness, however, a shell has little bending resistance and is unsuitable for concentrated loads.



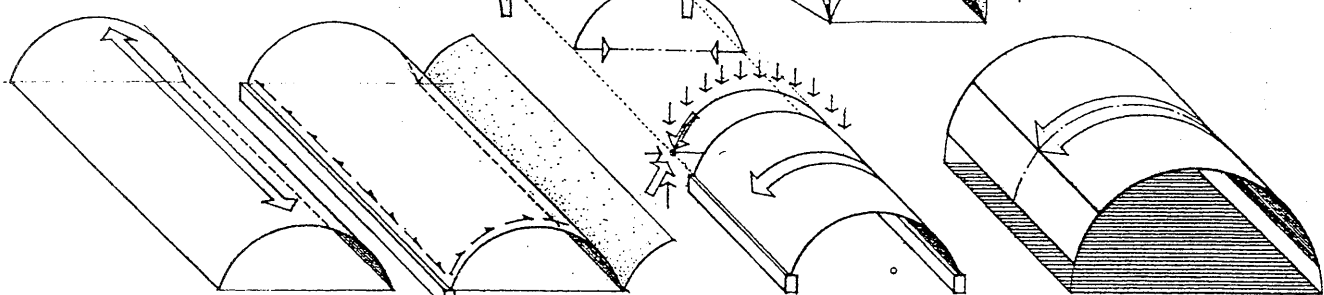
**thin shell**

A shell structure constructed of reinforced concrete.

A thin, curved plate structure, shaped to transmit applied forces by compressive, tensile, and shear stresses acting in the plane of the surface.

**translational surface**

A surface generated by sliding a plane curve along a straight line or over another plane curve.



**barrel shell**

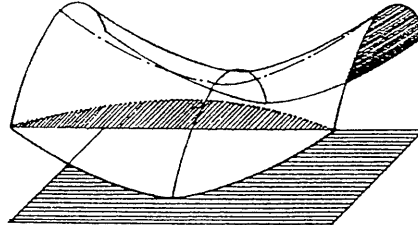
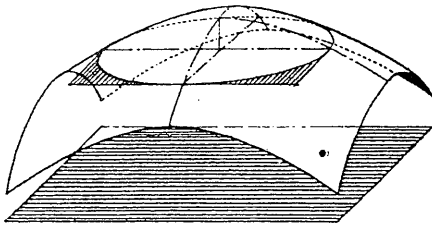
A rigid cylindrical shell structure.

If the length of a barrel shell is three or more times its transverse span, it behaves as a deep beam with a curved section spanning in the longitudinal direction. Edges are stiffened with beams or adjoining shells.

If it is relatively short, it exhibits archlike action. Tie rods, transverse rigid frames, or the like are required to counteract the outward thrusts of the arching action.

**cylindrical surface**

A surface generated by sliding a straight line along a plane curve, or vice versa. Depending on the curve, a cylindrical surface may be circular, elliptic, or parabolic. Because of its straight line geometry, a cylindrical surface can be regarded as being either a translational or a ruled surface.



**elliptic paraboloid**

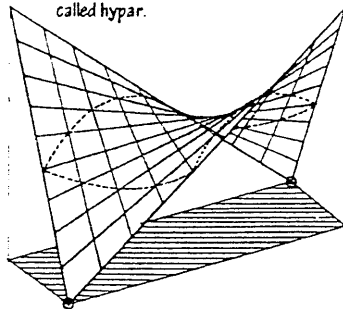
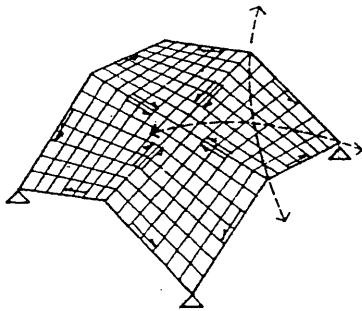
A surface generated by sliding a vertical parabola with downward curvature along a perpendicular parabola with downward curvature. Its horizontal sections are ellipses while its vertical sections are parabolas.

**hyperbolic paraboloid**

A surface generated by sliding a parabola with downward curvature along a parabola with upward curvature, or by sliding a straight line segment with its ends on two skew lines. It can be considered to be both a translational and a ruled surface. Also called hyper.

**paraboloid**

A surface all of whose intersections by planes are either parabolas and ellipses or parabolas and hyperbolas.



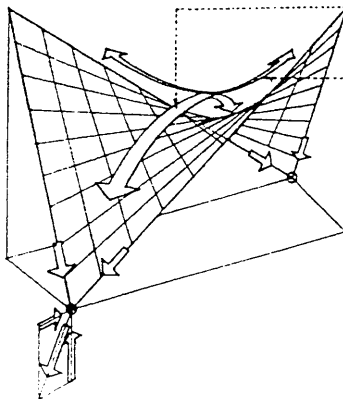
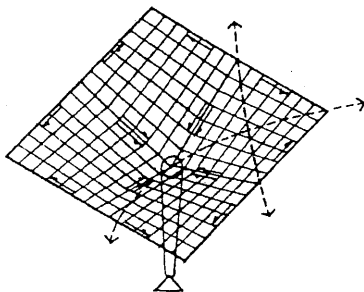
**saddle surface**

A surface having an upward curvature in one direction and a downward curvature in the perpendicular direction.

In a saddle-surfaced shell structure, regions of downward curvature exhibit archlike action, while regions of upward curvature behave as a cable structure. If the edges of the surface are not supported, beam behavior may also be present.

**anticlastic**

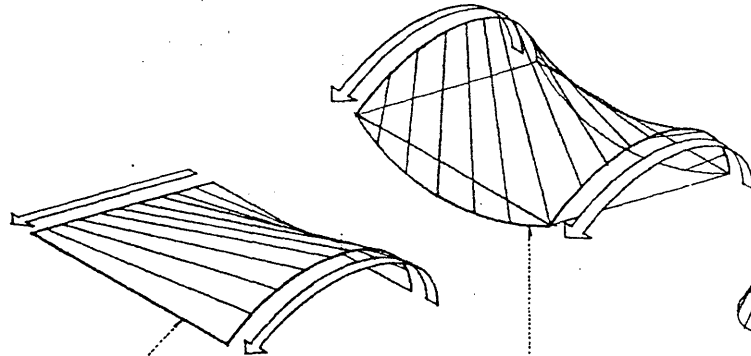
Having opposite curvatures at a given point.



# SHELL

## ruled surface

A surface generated by the motion of a straight line. Because of its straight line geometry, a ruled surface is generally easier to form and construct than a rotational or translational surface.

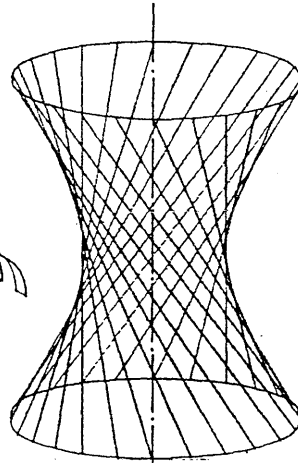


## conoid

A ruled surface generated by sliding a straight line with one end on a straight line segment and the other on a plane curve. Depending on the curve, a conoid may be circular, elliptic, or parabolic.

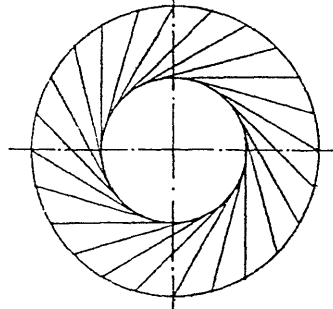
## hyperboloid

A surface having a finite center with certain plane sections that are hyperbolas and others that are circles or ellipses.



## one-sheet hyperboloid

A ruled surface generated by sliding an inclined line segment on two horizontal circles. Its vertical sections are hyperbolas.



## rotational surface

A surface generated by rotating a plane curve about an axis.

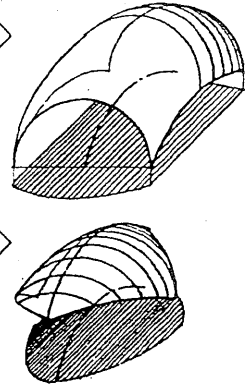
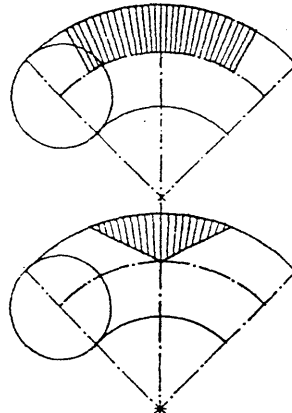
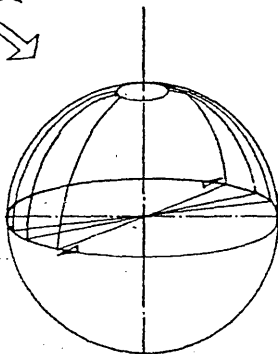
## synclastic

Having similar curvatures at a given point.



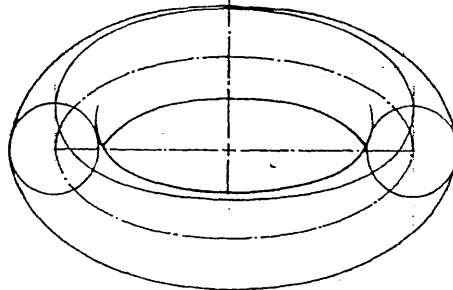
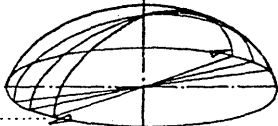
## spherical surface

A rotational surface generated by the revolution of a circular arc about a vertical axis.



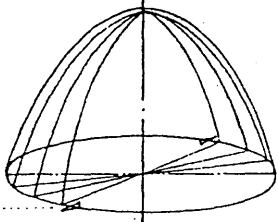
## elliptical surface

A rotational surface generated by the revolution of a half ellipse about a vertical axis.



## parabolic surface

A rotational surface generated by the revolution of a parabola about a vertical axis.



## torus

A doughnut-shaped surface generated by the revolution of a circle about an exterior line lying in its plane.



Work done at a site in preparation for a construction project, as excavation, sheeting, shoring, and grading.

**encroachment**

The unauthorized extension of a building, or part thereof, on the property or domain of another.

**setback**

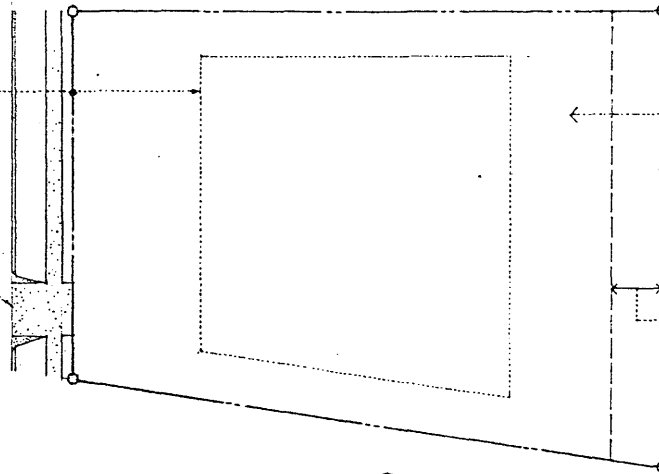
The minimum required distance from every structure to the property lines of a lot, established by a zoning ordinance to provide for air, light, solar access, and privacy.

**curb cut**

A depression in a curb providing vehicular access from a street to a driveway on private property.

**contract limit**

A perimeter line established on the drawings or elsewhere in the contract documents defining the boundaries of the site available to the contractor for construction purposes.



**site**  
The geographic location of a construction project, usually defined by legal boundaries.

**property line**  
One of the legally defined and recorded boundaries of a parcel of land. Also called lot line.

**easement**  
A legal right held by specified persons or the public to make limited use of the land of another, as a right-of-way.

**overburden**

Waste earth and rock overlying a useful mineral deposit, bedrock, or a deposit of sand, gravel, or rock needed for construction. Also called burden.

**test pit**

A small pit dug to examine the existing soil conditions and determine the depth of the water table at a proposed building site.

**shoring**

A system of shores for bracing or supporting a wall or other structure.

**shore**

A temporary supporting strut, esp. one placed obliquely against the side of an excavation, formwork, or structure.

**raker**

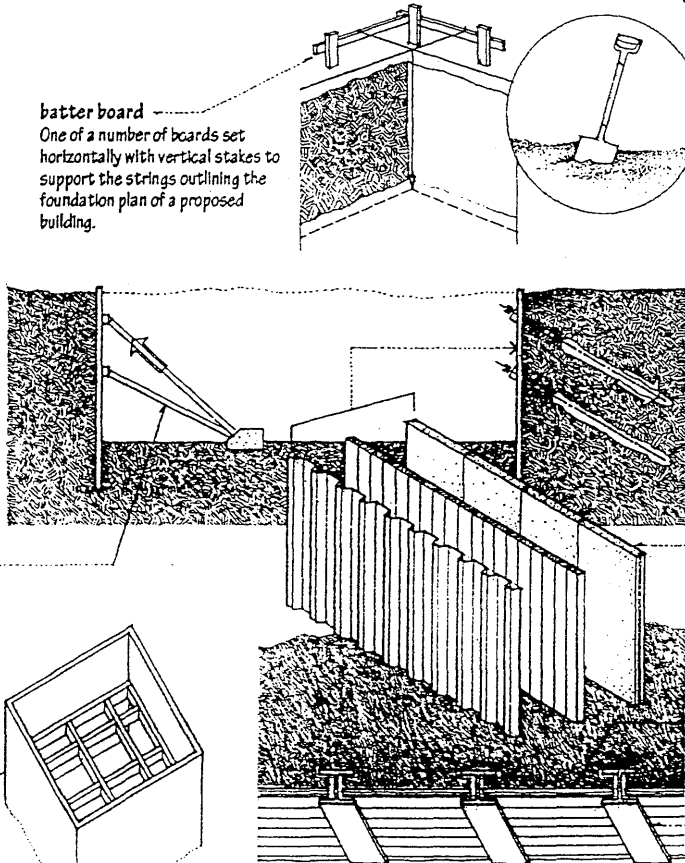
An inclined shore for supporting a wall. Also called raking shore.

**flying shore**

A horizontal strut fixed between and supporting two walls above ground level.

**cofferdam**

A watertight enclosure constructed underwater or in water-bearing soil and pumped dry to allow access for construction or repairs.



**batter board**  
One of a number of boards set horizontally with vertical stakes to support the strings outlining the foundation plan of a proposed building.

**groundbreaking**  
The act or ceremony of breaking ground for a new construction project.

**earthwork**

The excavation and embankment of earth in connection with an engineering operation.

**excavation**

The digging and removal of earth from its natural position, or the cavity resulting from such removal.

**tieback**

A steel rod or tendon attached to a deadman or a rock or soil anchor to prevent lateral movement of a retaining wall or formwork.

**sheet pile**

Any of a number of timber, steel, or precast concrete planks driven vertically side by side to retain earth or prevent water from seeping into an excavation. Also called sheath pile.

**lagging**

A number of boards joined together side by side to retain the face of an excavation.

**soldier pile**

A steel H-section driven vertically into the ground to support horizontal sheeting or lagging. Also called soldier beam.

**dewater**

To remove water from an excavated job site, usually by draining or pumping.

**boil**

An unwanted flow of water and solid matter into an excavation, due to excessive outside water pressure. Also called blow.

**Abyssinian well**

A perforated pipe driven into the ground for pumping out collected ground water.

**wellpoint**

A perforated tube driven into the ground to collect water from the surrounding area so it can be pumped away, as to lower a water table or to prevent an excavation from filling with groundwater.

**tremie**

A funnellike device with a pipe or tube for depositing concrete underwater.

**slurry wall**

A concrete wall cast in a trench to serve as sheeting and often as a permanent foundation wall, constructed by excavating a trench in short lengths, filling it with a slurry of bentonite and water to prevent the sidewalls from collapsing, setting reinforcement, and placing concrete in the trench with a tremie to displace the slurry.

# SITWORK

**fill**

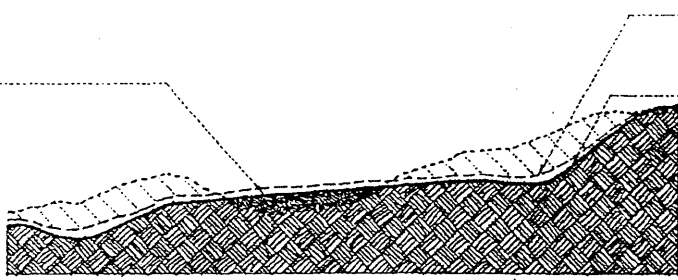
To raise an existing grade with earth, stone, or other material, or the quantity of material used in building up the level of an area.

**made ground**

Ground that has been raised to a higher level by filling with hard rubble, as stone or broken brick. Also called made-up ground.

**borrow pit**

A pit from which sand, gravel, or other construction material is taken for use as fill in another location.



**rough grading**

The cutting, filling, and shaping of earth in preparation for finish grading.

**fine grading**

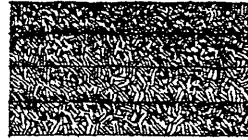
The precise grading of an area after rough grading to prepare for paving, seeding, or planting.

**grade stake**

A stake marking the amount of cut or fill required to bring the ground to a specified level.

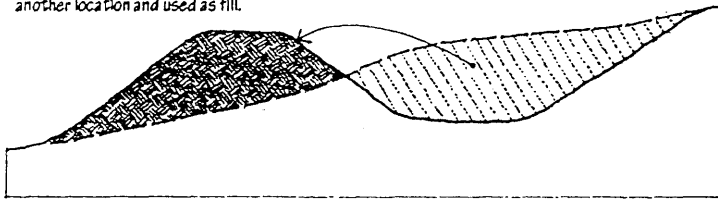
**controlled fill**

Fill material that is placed in layers, compacted, and tested after each compaction for moisture content, depth of lift, and bearing capacity before additional layers are placed.



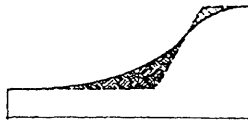
**cut and fill**

An excavating operation in which the excavated material is moved to another location and used as fill.



**vertical curve**

A smooth parabolic curve in the vertical plane for connecting two grades of different slope in order to avoid an abrupt transition.



**bench terrace**

An embankment constructed across sloping ground with a steep drop on the downside.



**grade**

The ground elevation at any specific point on a construction site, esp. where the ground meets the foundation of a building. Also called grade line.

**existing grade**

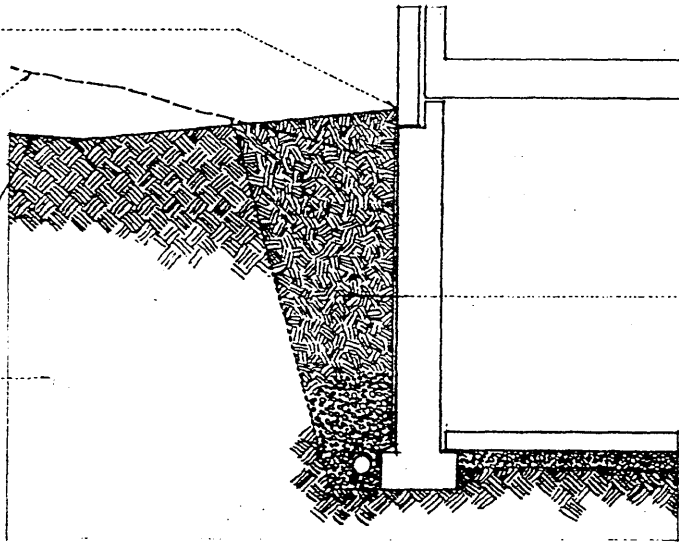
The elevation of the original ground surface before excavation or grading begins. Also called natural grade.

**finish grade**

The elevation of drives, walks, lawns, or other improved surfaces after completion of construction or grading operations. Also, finished grade.

**below grade**

Occurring or situated below the surface of the ground.



**backfill**

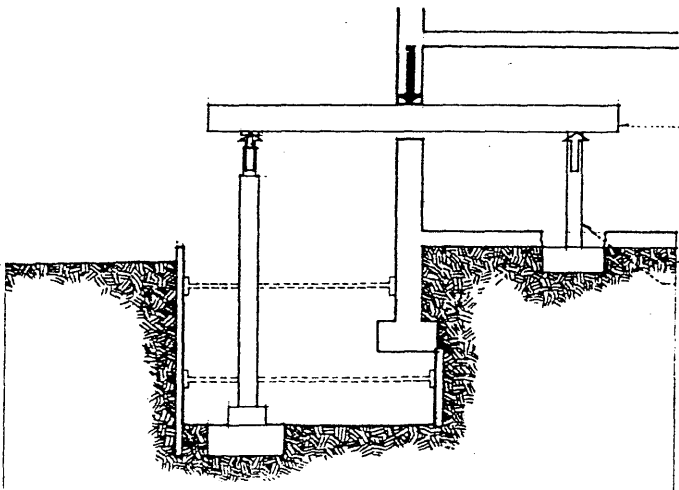
To refill an excavation with earth, stone, or other material, esp. the space around exterior foundation walls.

**subgrade**

The prepared earth surface upon which a pavement, concrete slab, or foundation is built. A subgrade should be stable, drain well, and be relatively free of frost action.

**underpinning**

A system of supports that enables an existing foundation to be rebuilt, strengthened, or deepened, esp. the additional support required when a new excavation in adjoining property is deeper than the existing foundation.



**needle**

A short beam passed through a wall as a temporary support while the foundation or part beneath is repaired, altered, or strengthened. Also called needle beam.

**dead shore**

An upright timber for supporting a dead load during the structural alteration of a building, esp. one of two supports for a needle.

**swale**  
A shallow depression formed by the intersection of two ground slopes, often designed to direct or divert the runoff of surface water.

**runoff**  
Something that drains or flows off, as rain that flows off the land in streams.

**site drainage**  
The surface and subsurface drainage of a site in order to prevent the collection of excess surface water or groundwater.

**surface drainage**  
The grading and surfacing of a site in order to divert rain and other surface water into natural drainage patterns or a storm sewer system.

**groundwater**  
The water beneath the surface of the ground that supplies wells and springs, consisting largely of surface water that has seeped down.

**recharge**  
The process by which groundwater is absorbed into the water table.

**water table**  
The underground surface beneath which the earth is saturated with water.

**perched water table**  
A water table of limited area, held above the normal water table by an impervious layer.

**cutoff**  
A wall or other structure intended to eliminate or reduce percolation through porous strata.

**curtain drain**  
A drain placed between the source of water and the area to be protected. Also called intercepting drain.

**underdrain**  
A perforated pipe installed in porous fill to draw off groundwater.

**French drain**  
A drainage trench filled to ground level with loose stones or rock fragments.

**culvert**  
A drain or channel passing under a road or sidewalk.

**box culvert**  
A reinforced concrete culvert having a rectangular cross section.

**headwall**  
A concrete or masonry retaining wall at the inlet of a drain or culvert.

**endwall**  
A concrete or masonry retaining wall at the outlet of a drain or culvert.

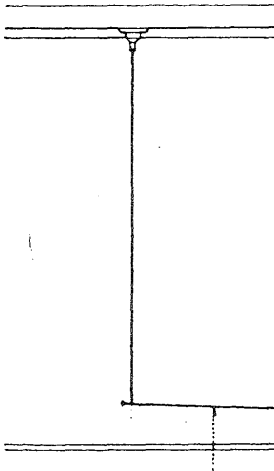
**subsurface drainage**  
An underground network of piping for conveying groundwater to a point of disposal, as a storm sewer system. Excess groundwater reduces the load-carrying capacity of a foundation soil and increases the hydrostatic pressure on a building foundation.

**area drain**  
A drain for collecting surface water or rainwater from a basement floor or paved area.

**dry well**  
A drainage pit lined with gravel or rubble to receive surface water and allow it to percolate away to absorbent earth underground. Also called absorbing well.

**manhole**  
A covered hole through which a person may enter a sewer or drain.

**catch basin**  
A receptacle for the runoff of surface water, having a basin which retains heavy sediment before it can pass into an underground drainpipe.

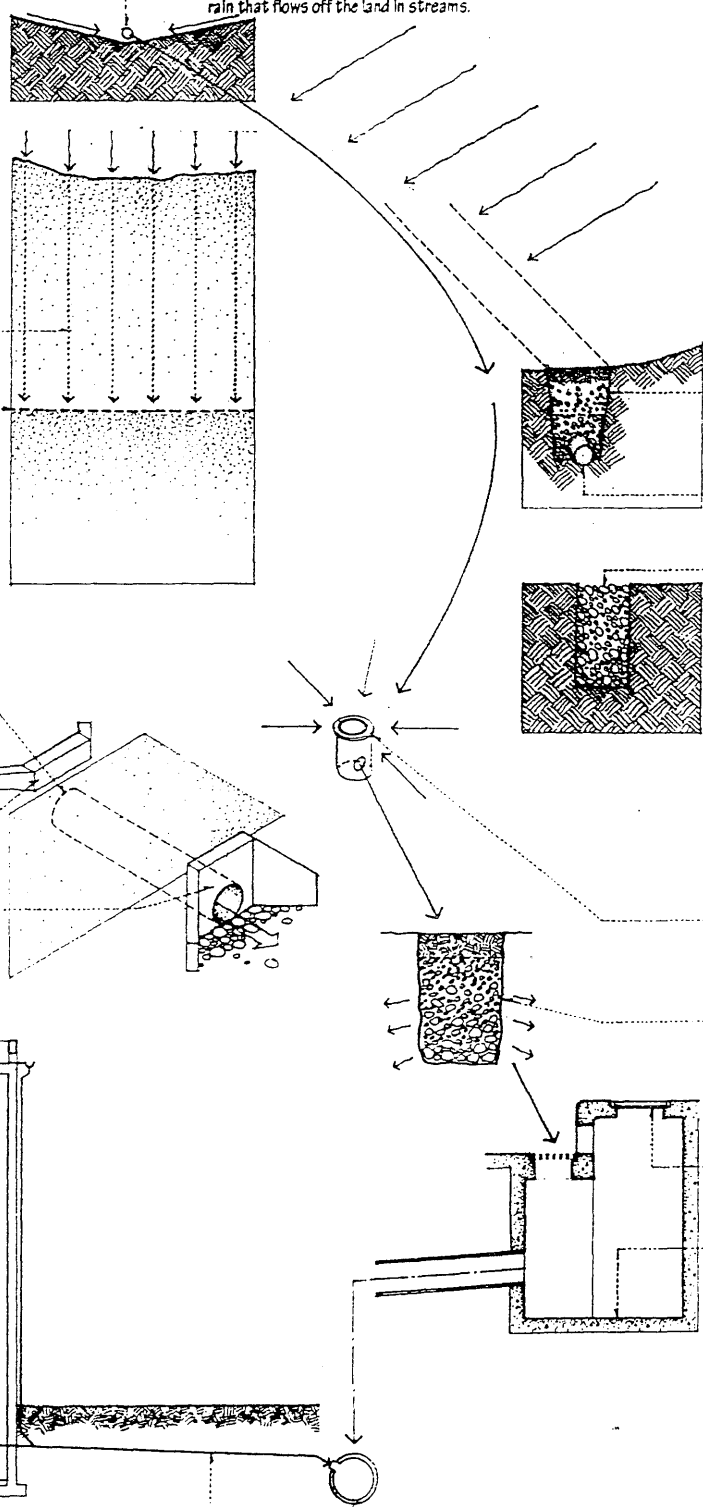


**building storm drain**  
A building drain for conveying rainwater, groundwater, or similar discharge to a building storm sewer or a combined sewer. Also called house storm drain.

**building storm sewer**  
A drain connecting a building storm drain to a storm sewer, combined sewer, or other point of disposal. Also called house storm sewer.

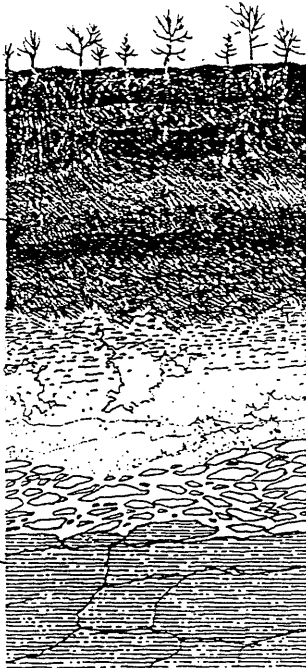
**storm sewer**  
A sewer for conveying rainfall drained from roofs and paved surfaces. Also called storm drain.

**combined sewer**  
A sewer conveying both sewage and rainfall drained from roofs and paved surfaces.



# SOIL

The top layer of the earth's surface, consisting of disintegrated rock and decayed organic matter suitable for the growth of plant life.



**topsoil**  
The fertile surface layer of soil, as distinct from the subsoil.

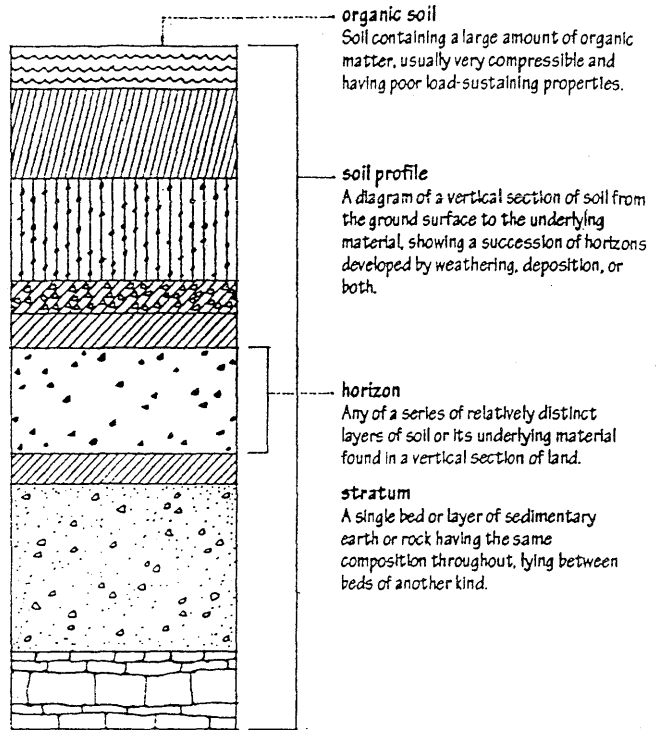
**subsoil**  
The bed or layer of earth immediately beneath the surface soil.

**permafrost**  
Perennially frozen subsoil in arctic or subarctic regions. Also called pergelisol.

**bedrock**  
The unbroken, solid rock that underlies all unconsolidated material on the earth's surface, as soil, clay, sand, or rock fragments.

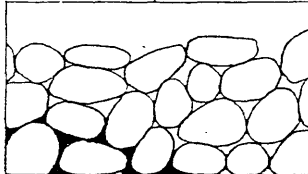
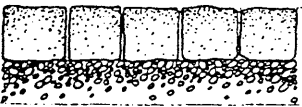
**soil analysis**  
A process for determining the particle-size distribution in an aggregate, soil, or sediment.

**soil class**  
A numerical classification of soil by texture, used by the U.S. Department of Agriculture: (1) gravel, (2) sand, (3) clay, (4) loam, (5) loam with some sand, (6) silt-loam, and (7) clay-loam.



**boulder**  
A large, naturally rounded rock, lying on the surface of the ground or partially embedded in it.

**cobble**  
A naturally rounded stone, smaller than a boulder and larger than a pebble, used for rough paving, walls, and foundations. Also called cobblestone.



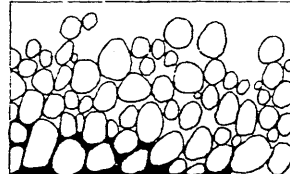
**gravel**  
Small pebbles and stones, or a mixture of these with sand, formed either naturally or by crushing rock, esp. such material that will pass a 3-in. (76 mm) sieve and be retained on a No. 4 (4.8 mm) sieve.

**crushed gravel**  
Gravel having one or more fractured faces produced by mechanical crushing.

**crushed stone**  
Stone having well-defined edges produced by the mechanical crushing of rocks or boulders. Also called crushed rock.

**pea gravel**  
A small-diameter, natural gravel, usually 1/4 to 3/8 in. (6.4 to 9.5 mm) in size, screened to specification.

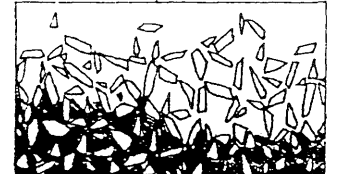
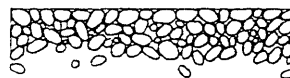
**pebble**  
A small, rounded stone, especially one worn smooth by the action of water.



**sand**  
A loose, granular material resulting from the disintegration of rocks, consisting of grains smaller than gravel but coarser than silt.

**sand clay**  
A well-graded, naturally occurring sand often used as a base or subbase material, having about 10% clay or just enough to make the mixture bind tightly when compacted.

**silt**  
Loose sedimentary material consisting of fine mineral particles between 0.002 mm and 0.075 mm in diameter.



**clay**  
A natural, earthy material that is plastic when moist but hard when fired and is used for making brick, tile, and pottery, composed mainly of fine particles of hydrous aluminum silicates less than 0.002 mm in diameter.

**clay loam**  
Soil containing 27% to 40% clay and 20% to 45% sand.

**bentonite**  
A clay formed by the decomposition of volcanic ash, having the ability to absorb large amounts of water and to expand to several times its natural volume.

**loam**  
A rich soil containing a relatively equal mixture of sand and silt and a smaller proportion of clay and organic matter.

**loess**  
An unstratified, cohesive, loamy deposit deposited by wind.

**Atterberg limits**

The levels of water content defining the boundaries between the different states of consistency of a plastic or cohesive soil, as determined by standard tests.

**liquid limit**

The water content, expressed as a percentage of dry weight, at which a soil passes from a plastic to a liquid state.

**plasticity index**

The numerical difference between the liquid limit and the plastic limit of a soil.

**plastic limit**

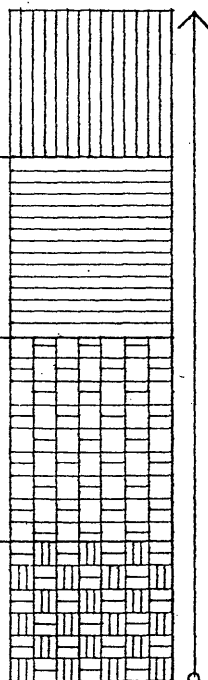
The water content, expressed as a percentage of dry weight, at which a soil loses its plasticity and begins to behave as a solid.

**plastic soil**

A soil that can be rolled into 1/8 in. (3.2-mm) diameter threads without crumbling.

**shrinkage limit**

The water content, expressed as a percentage of dry weight, at which a reduction in water content will not cause a further decrease in the volume of a soil mass.

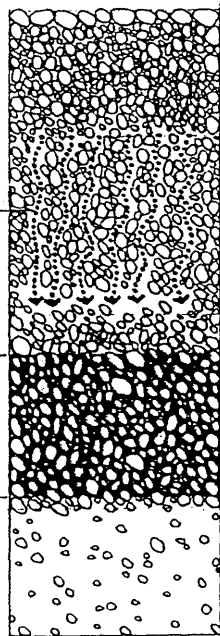


**granular material**

Any gravel, sand, or silt that exhibits no cohesiveness or plasticity.

**permeability**

The property of a porous material that allows a gas or liquid to pass through its pore spaces.



**void ratio**

The ratio of the volume of void spaces to the volume of solid particles in a soil mass.

**critical void ratio**

The void ratio corresponding to the critical density of a soil mass.

**critical density**

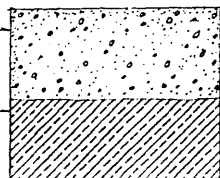
The unit weight of a saturated granular material above which it will gain strength and below which it will lose strength when subjected to rapid deformation.

**pervious soil**

Any permeable soil that allows the relatively free movement of water.

**impervious soil**

Any fine-grained soil, as clay, having pores too small to permit water to pass except by slow capillary action.

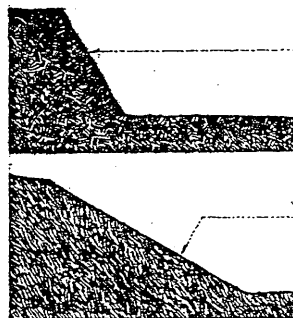


**geotechnical**

Of or pertaining to the practical applications of geological science in civil engineering.

**foundation investigation**

The investigation and classification of a foundation soil based on observation and tests of material disclosed by borings or excavations to obtain the information necessary for the design of a foundation system, including the shearing strength, compressibility, cohesion, expansiveness, permeability, and moisture content of the soil, the elevation of the water table, and the anticipated total and differential settlement. Also called subsurface investigation.



**soil mechanics**

The branch of civil engineering that deals with the mechanical behavior of soil when compressed or sheared, or when water flows through it.

**soil structure**

The arrangement and aggregation of soil particles in a soil mass.

**core**

An undisturbed, cylindrical sample of earth or rock obtained by means of a core drill and used for analysis and testing of bearing capacity. Also called boring.

**cohesive soil**

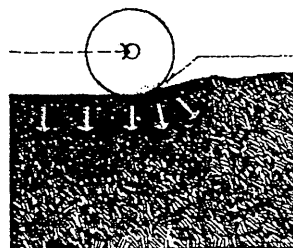
Soil that has considerable strength when unconfined and air-dried, and significant cohesion when submerged.

**cohesionless soil**

Soil that has little or no strength when unconfined and air-dried, and little or no cohesion when submerged.

**compaction**

The consolidation of sediment by the weight of overlying deposits, or a similar compression of soil, aggregate, or cementitious material by rolling, tamping, or soaking.

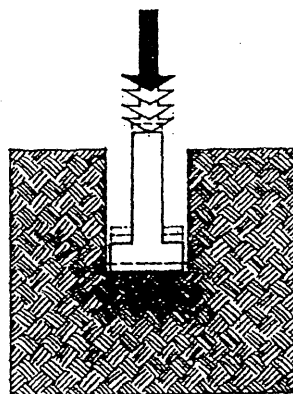


**optimum moisture content**

The water content of a soil at which maximum density can be attained through compaction.

**penetration test**

A test for measuring the density of granular soils and the consistency of some clays at the bottom of a borehole, recording the number of blows required by a hammer to advance a standard soil sampler.

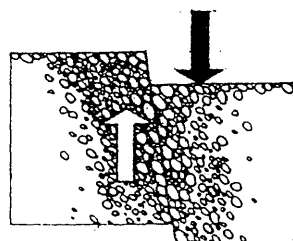


**penetration resistance**

The unit load required to produce a specified penetration into a soil at a specified rate of penetration.

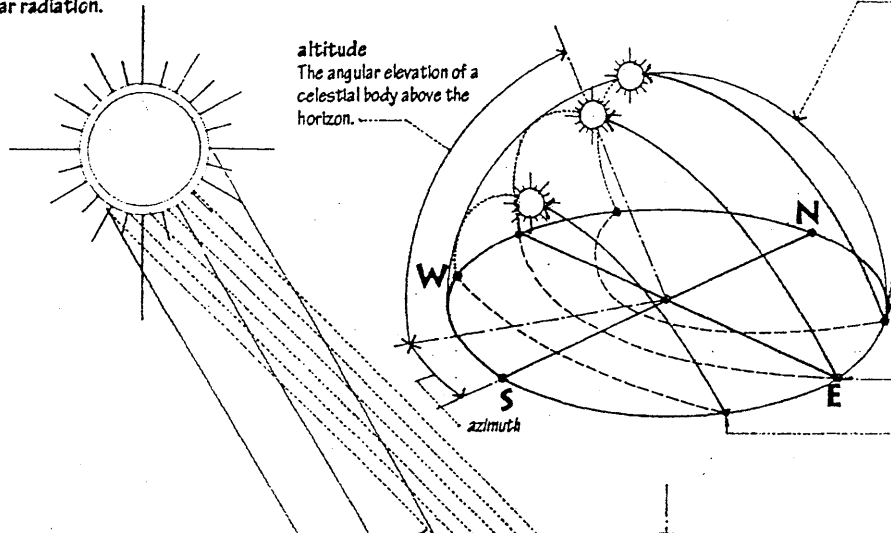
**shearing strength**

The property of a soil that enables its particles to resist displacement with respect to one another when an external force is applied, due largely to the combined effects of cohesion and internal friction. Also called shearing resistance.



# SOLAR ENERGY

Energy derived from the sun in the form of solar radiation.



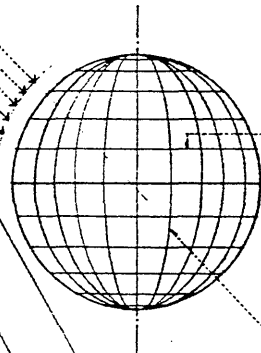
**solar path diagram**  
A graphic depiction of the path of the sun within the sky vault projected onto a horizontal plane.

**summer solstice**  
The time of year, on or about June 21, when the sun reaches its northernmost point on the celestial sphere, marking the beginning of summer in the northern hemisphere.

**equinox**  
Either of the two times during the year when the sun crosses the plane of the celestial equator and when the length of day and night are everywhere approximately equal, occurring about March 21 (vernal equinox or spring equinox) and September 21 (autumnal equinox).

**winter solstice**  
The time of year, on or about December 21, when the sun reaches its southernmost point on the celestial sphere, marking the beginning of winter in the northern hemisphere.

**solar constant**  
The average rate at which radiant energy from the sun is received by the earth, equal to 430 Btu per hr. per sq. ft. (1.94 cal per min. per sq. cm), used in calculating the effects of solar radiation on buildings.



**latitude**  
The angular distance north or south from the equator of a point on the earth's surface, measured in degrees along the meridian passing through the point.

**meridian**  
A great circle on the earth's surface passing through both geophysical poles.

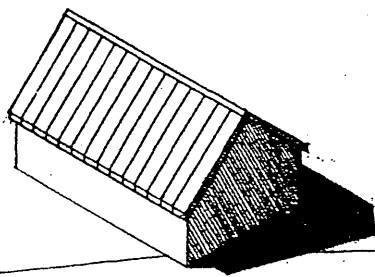
**longitude**  
The angular distance east or west on the earth's surface, measured from the prime meridian at Greenwich, England, to the meridian of a given point and expressed either in degrees or a corresponding difference in time.

**solar house**  
A house designed to absorb and store solar heat in order to supplement or replace conventional heating methods.

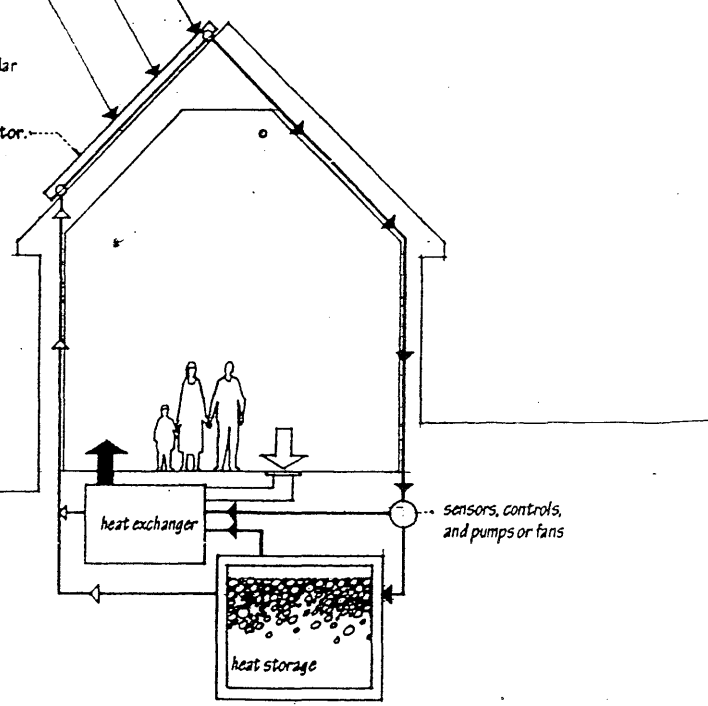
**solar-heating system**  
A heating system using solar energy as the primary source of heat.

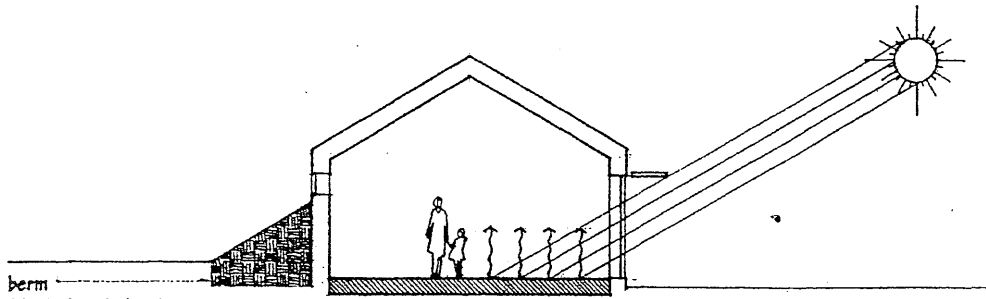
**active solar-heating system**  
A solar-heating system using mechanical means, as solar collectors, fans, or pumps, to collect, store, and distribute solar energy.

**solar collector**  
A device or system designed to use solar radiation to heat an absorber through which a transporting medium, as air or water, is circulated. Also called collector.



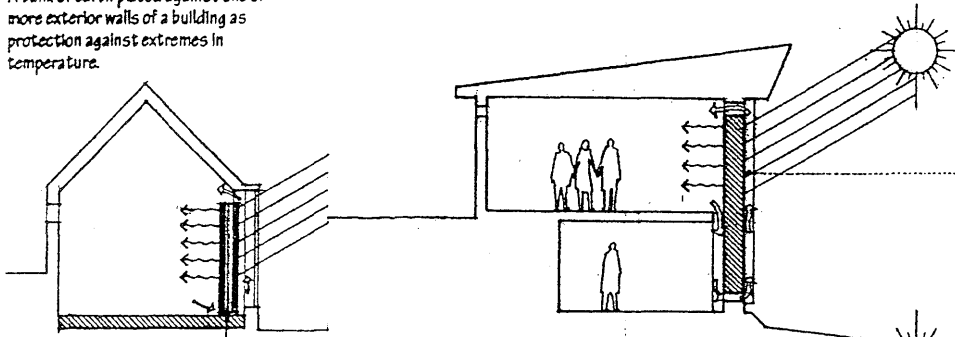
**solar orientation**  
The placing of a building in relation to the path of the sun, either to maximize the amount of heat gained from solar radiation during the coldest months, or to minimize the amount of heat gained in the warmest months.





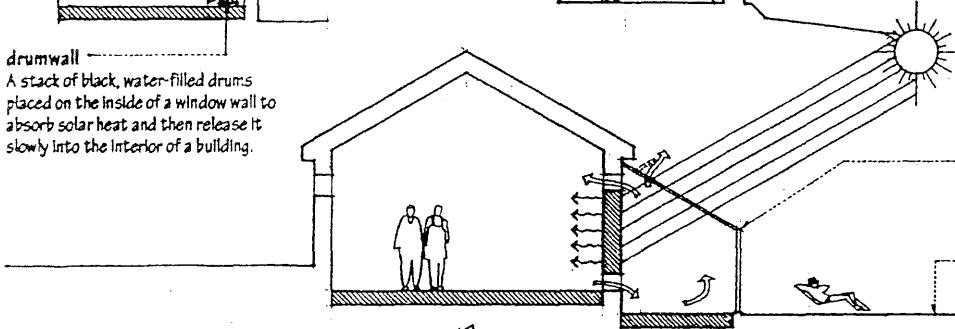
**berm**  
A bank of earth placed against one or more exterior walls of a building as protection against extremes in temperature.

**passive solar-heating**  
A solar-heating system using a building's design and construction and the natural flow of heat to collect, store, and distribute solar energy, with minimal use of fans or pumps.



**Trombe wall**  
A glass-fronted exterior masonry wall that absorbs solar heat for radiation into the interior of a building, usually after a time-lag of several hours.

**drumwall**  
A stack of black, water-filled drums placed on the inside of a window wall to absorb solar heat and then release it slowly into the interior of a building.

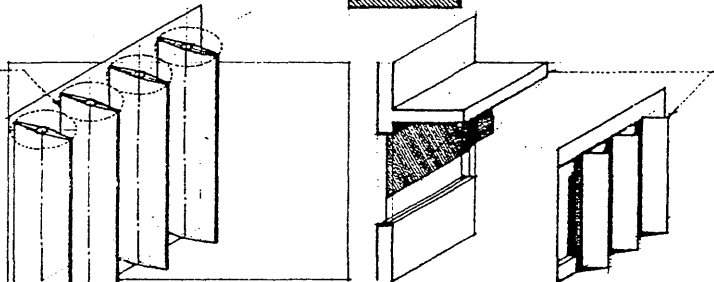


**solarium**  
A glass-enclosed porch, room, or gallery used for sunbathing or for therapeutic exposure to sunlight.

**sunroom**  
A glass-enclosed porch or room oriented to admit large amounts of sunlight. Also called sun parlor, sun porch.

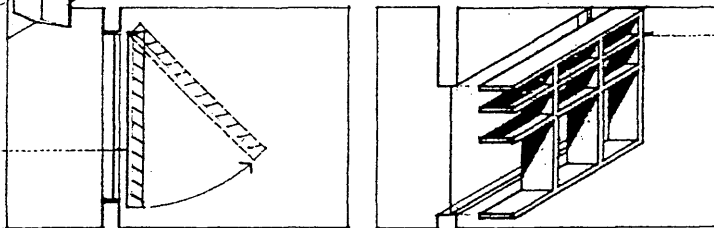
**sun deck**  
A roof, balcony, or terrace that is exposed to the sun and used for sunbathing.

**sun control**  
Any of various exterior devices for regulating the amount of solar heat and sunlight that enters a window, consisting of movable horizontal or vertical fins controlled manually or operated automatically with time or photoelectric controls.



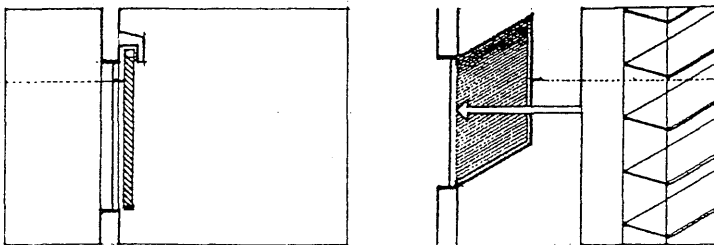
**sunshade**  
Any of various exterior devices consisting of fixed horizontal or vertical fins angled to shield a window from direct sunlight.

**shutter panel**  
A lowered awning the metal fins of which are angled to shade a window from direct sunlight and glare while preserving the outside view and admitting soft, diffused light.



**brise-soleil**  
A screen, usually of louvers, placed on the outside of a building to shield the windows from direct sunlight.

**shutter blind**  
A manually or electrically controlled exterior venetian blind for protecting a building interior from solar gain and glare.



**solar screen**  
A panel of miniature external louvers for shading a window from direct sunlight and glare while allowing a high degree of visibility, daylighting, ventilation, visual daytime privacy, and insect protection.

# SOUND

The sensation stimulated in the organs of hearing by mechanical radiant energy transmitted as longitudinal pressure waves through the air or other medium.

## sound wave

A longitudinal pressure wave in air or an elastic medium, esp. one producing an audible sensation.

## wave

A disturbance or oscillation that transfers energy progressively from point to point in a medium or space without advance by the points themselves, as in the transmission of sound or light.

## waveform

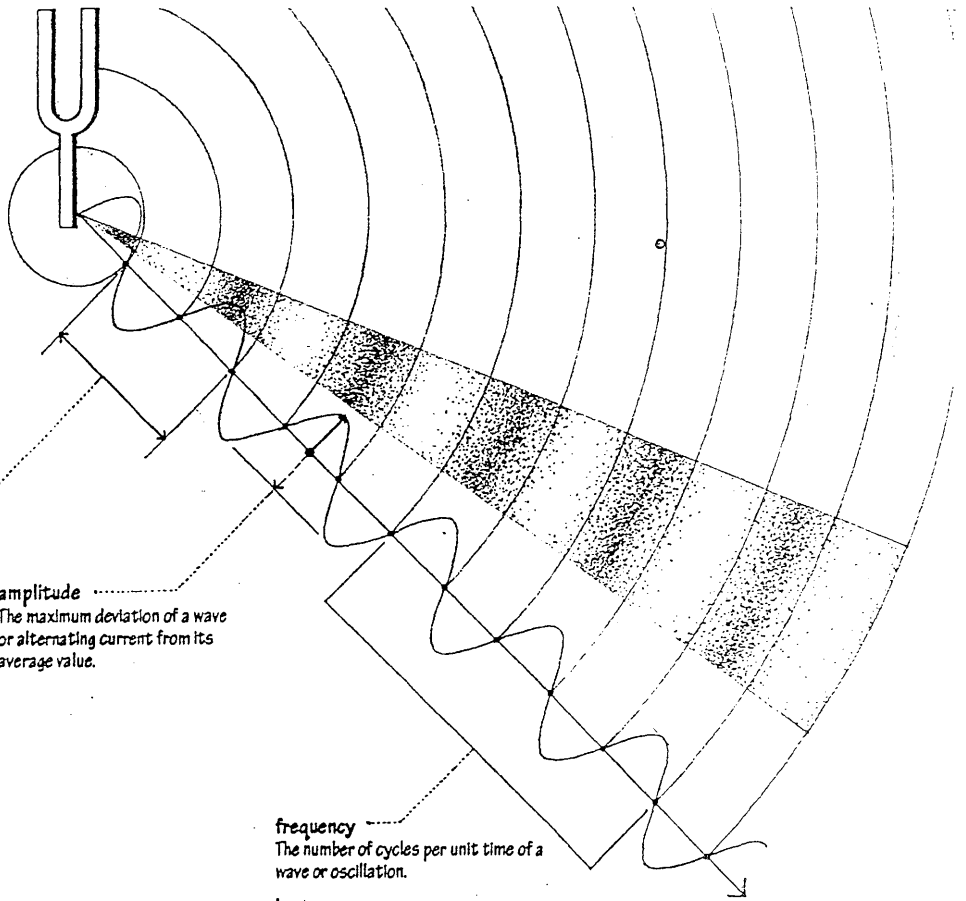
A graphic representation of the shape of a wave, obtained by plotting deviation at a fixed point versus time.

## wavelength

The distance, measured in the direction of propagation of a wave, from any one point to the next point of corresponding phase.

## phase

A particular point or stage in a periodic cycle or process.



## amplitude

The maximum deviation of a wave or alternating current from its average value.

## frequency

The number of cycles per unit time of a wave or oscillation.

## hertz

The SI unit of frequency, equal to one cycle per second. Abbr.: Hz

## wave front

A surface of a propagating wave composed at any instant of all points having identical phase; usually perpendicular to the direction of propagation.

## fundamental

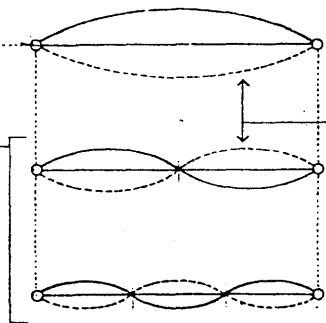
The lowest frequency at which a vibrating element or system will freely oscillate. Also called fundamental frequency.

## harmonic

A vibration having a frequency that is an integral multiple of that of the fundamental.

## band

A range of wavelengths or frequencies between two defined limits.

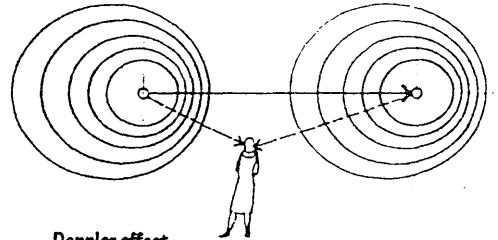


## pitch

The predominant frequency of a sound as perceived by the human ear.

## octave

The interval between two frequencies having a ratio of 2:1.

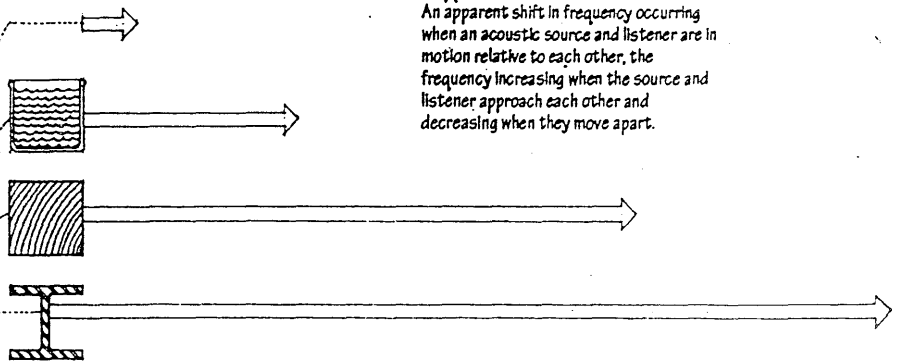


## Doppler effect

An apparent shift in frequency occurring when an acoustic source and listener are in motion relative to each other, the frequency increasing when the source and listener approach each other and decreasing when they move apart.

## speed of sound

The velocity of sound traveling through air at approximately 1087 ft. (0.3 km) per second at sea level, through water at approximately 4500 ft. (1.4 km) per second, through wood at approximately 11,700 ft. (3.6 km) per second, and through steel at approximately 18,000 ft. (5.5 km) per second.





**loudness**

A subjective response to sound indicating the magnitude of the auditory sensation produced by the amplitude of a sound wave.

**phon**

A unit for measuring the apparent loudness of a sound, equal in number to the decibels of a 1000-Hz reference sound judged by a group of listeners to be equal in loudness to the given sound.

**sone**

A unit for measuring the apparent loudness of a sound, judged by a group of listeners to be equal to the loudness of a 1000-Hz reference sound having an intensity of 40 decibels.

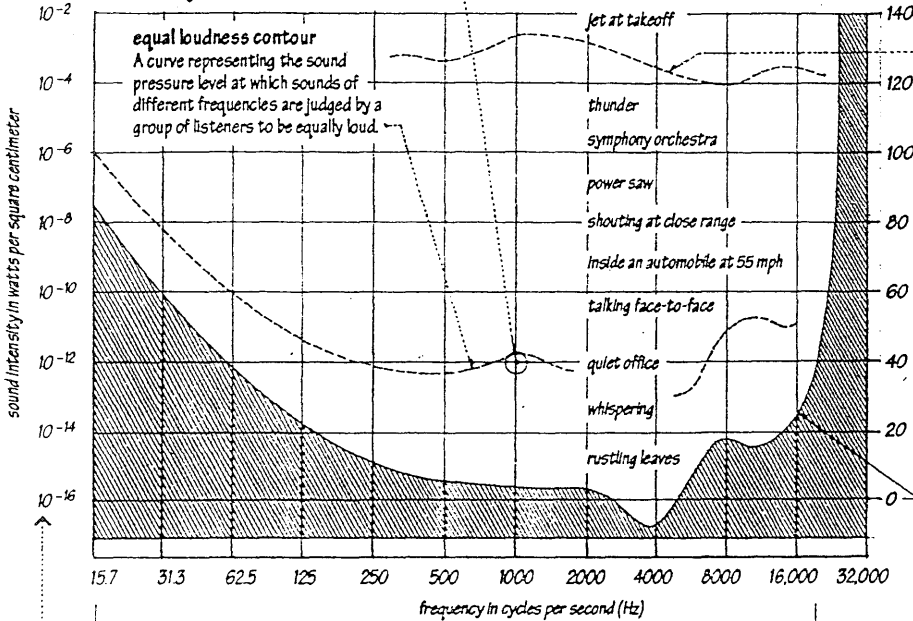
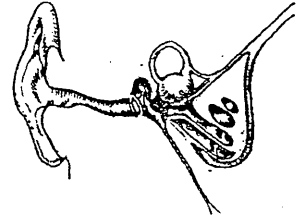
**decibel**

A unit for expressing the relative pressure or intensity of sounds on a uniform scale from 0 for the least perceptible sound to about 130 for the average threshold of pain. Abbr.: dB

Decibel measurement is based on a logarithmic scale since increments of sound pressure or intensity are perceived as equal when the ratio between successive changes in intensity remain constant. The decibel levels of two sound sources, therefore, cannot be added mathematically:  
e.g., 60 dB + 60 dB = 63 dB, not 120 dB.

**hearing**

The sense by which sound is perceived, involving the entire mechanism of the internal, middle, and external ear and including the nervous and cerebral operations that translate the physical operations into meaningful signals.



**equal loudness contour**

A curve representing the sound pressure level at which sounds of different frequencies are judged by a group of listeners to be equally loud.

**threshold of pain**

The level of sound intensity high enough to produce the sensation of pain in the human ear, usually around 130 dB.

**auditory fatigue**

Physical or mental weariness caused by prolonged exposure to loud noises.

**hearing loss**

An increase in the threshold of audibility, at specific frequencies, caused by normal aging, disease, or injury to the hearing organs.

**threshold of hearing**

The minimum sound pressure capable of stimulating an auditory sensation, usually 20 micropascals or zero dB.

**audio frequency**

A range of frequencies from 15 Hz to 20,000 Hz audible to the normal human ear.

**sound intensity**

The rate at which acoustic energy flows through a medium, expressed in watts per square meter.

**sound pressure**

The difference between the actual pressure at any point in the field of a sound wave and the static pressure at that point, expressed in pascals.

**sound power**

The amount of acoustic energy radiated by a source per unit time, expressed in watts.

**sound intensity level**

Sound intensity measured on the decibel scale, equal to 10 times the common logarithm of the ratio of the sound intensity to a reference intensity, usually 10<sup>-12</sup> watts per square meter (10<sup>-16</sup> watts per square centimeter.)

**sound pressure level**

Sound pressure measured on the decibel scale, equal to 10 times the common logarithm of the ratio of the sound pressure to a reference pressure, usually 20 micropascals.

**sound power level**

The acoustic power of a source, measured on the decibel scale, equal to 10 times the common logarithm of the ratio of the acoustic power to a reference power, usually 10<sup>-12</sup> watts.

**logarithm**

The exponent indicating the power to which a base number must be raised to arrive at a given number.

**micropascal**

One-millionth (10<sup>-6</sup>) part of a pascal. Symbol  $\mu\text{Pa}$

**sound level meter**

An electrical instrument for measuring sound pressure levels. To compensate for the way we perceive the relative loudness of different frequencies of sound, there are three networks: A, B, and C. These networks weight the recordings for different frequencies and combine the results in a single reading. The A-network scale, in dBA units, is most commonly used since it discriminates against the lower frequencies, as does the human ear at moderate sound levels.

**common logarithm**

A logarithm having a base of 10.

# SOUND

## acoustics

The branch of physics that deals with the production, control, transmission, reception, and effects of sound.

## room acoustics

The qualities or characteristics of a room, auditorium, or concert hall that determine the audibility of speech or fidelity of musical sounds in it.

## sounding board

A structure over or behind and above a speaker or orchestra to reflect the sound toward the audience.

## reflecting surface

A nonabsorptive surface from which incident sound is reflected, used esp. to redirect sound in a space. To be effective, a reflecting surface should have a least dimension equal to or greater than the wavelength of the lowest frequency of the sound being reflected.

## acoustical cloud

One of a number of acoustic panels installed near the ceiling of a concert hall to reflect sound for improving the acoustic quality of music.

## acoustical analysis

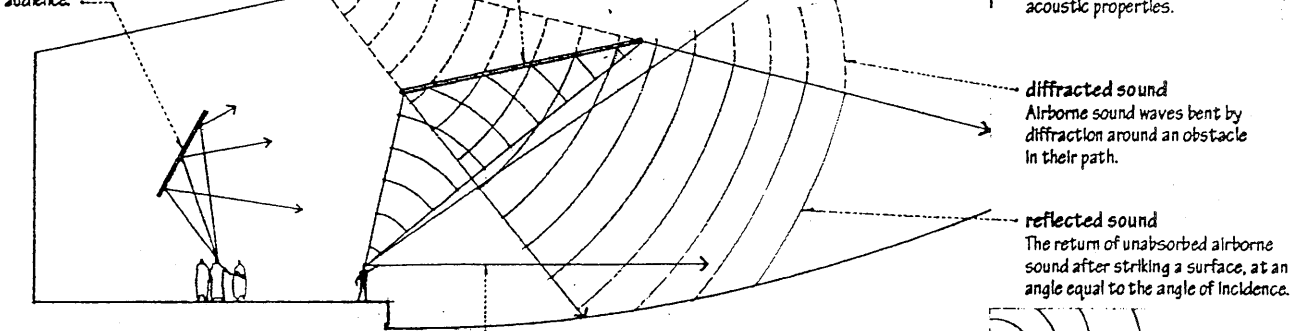
A detailed study of the use of a building, the location and orientation of its spaces, possible sources of noise, and the desirable acoustical environment in each usable area.

## acoustical design

The planning, shaping, finishing, and furnishing of an enclosed space to establish the acoustical environment necessary for distinct hearing.

## acoustical treatment

The application of absorbent or reflecting materials to the walls, ceiling, and floor of an enclosed space to alter or improve its acoustic properties.



## diffracted sound

Airborne sound waves bent by diffraction around an obstacle in their path.

## reflected sound

The return of unabsorbed airborne sound after striking a surface, at an angle equal to the angle of incidence.

## airborne sound

Sound radiated directly into and transmitted through the air.

## live

Highly reverberant or resonant, as an auditorium or concert hall.

## dead

Without resonance, as a room free from echoes and reverberation.

## soundproof

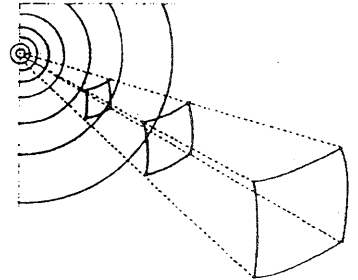
Impervious to audible sound.

## direct sound

Airborne sound traveling directly from a source to the listener. In a room, the human ear always hears direct sound before it hears reflected sound. As direct sound loses intensity, the importance of reflected sound increases.

## attenuation

A decrease in energy or pressure per unit area of a sound wave, occurring as the distance from the source increases as a result of absorption, scattering, or spreading in three dimensions.

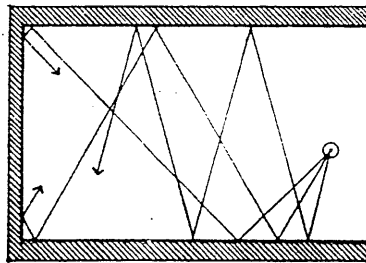
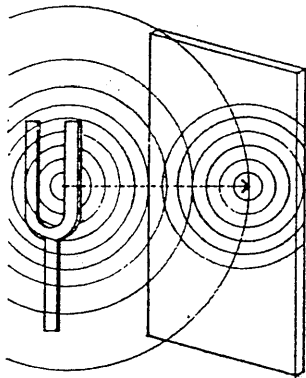


## resonance

The intensification and prolongation of sound produced by sympathetic vibration.

## sympathetic vibration

A vibration induced in one body by the vibrations of exactly the same period in a neighboring body.

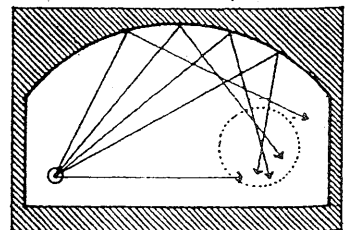
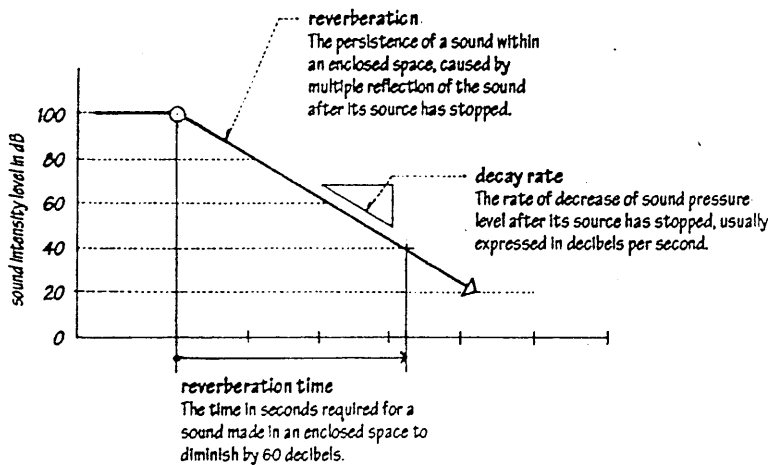


## echo

The repetition of a sound produced by the reflection of sound waves from an obstructing surface, loud enough and received late enough to be perceived as distinct from the source.

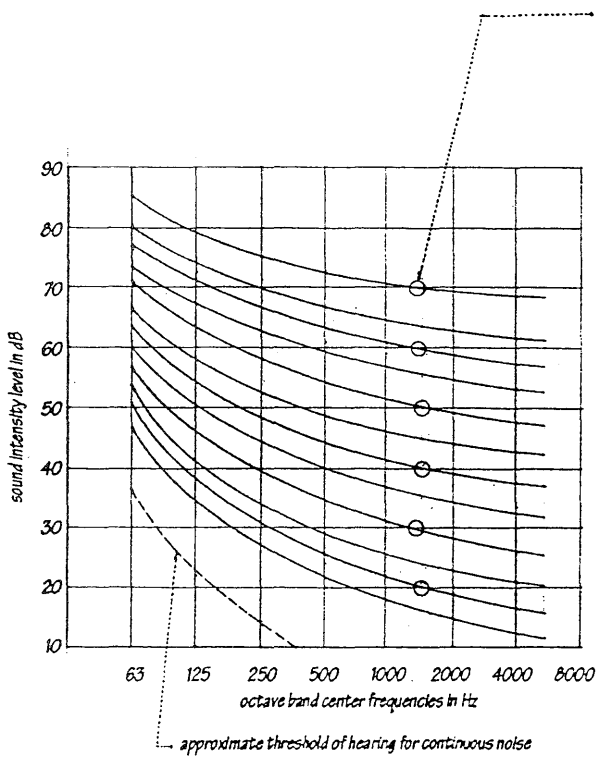
## flutter

A rapid succession of echoes caused by the reflection of sound waves back and forth between two parallel surfaces, with sufficient time between each reflection to cause the listener to be aware of separate, discrete signals.



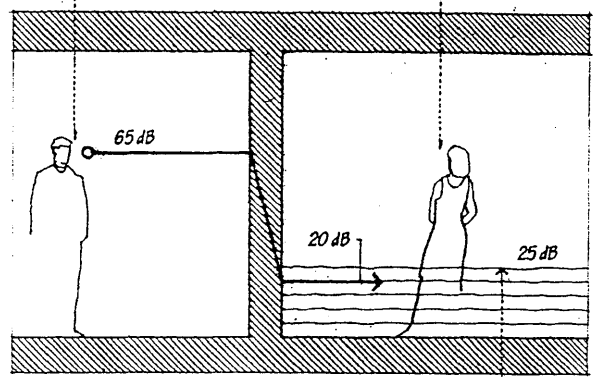
## focusing

The convergence of sound waves reflected from a concave surface.



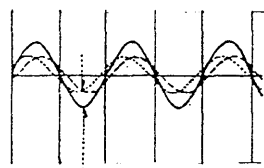
**noise**  
Any sound that is unwanted, annoying, or discordant, or that interferes with one's hearing of something.

**noise reduction**  
The perceived difference in sound pressure levels between two enclosed spaces, due to the sound-isolating qualities of the separating barrier as well as the absorption present in the receiving room: expressed in decibels.



**background noise level**  
The level of ambient sound normally present in a space, above which speech, music, or other sounds must be presented to be heard.

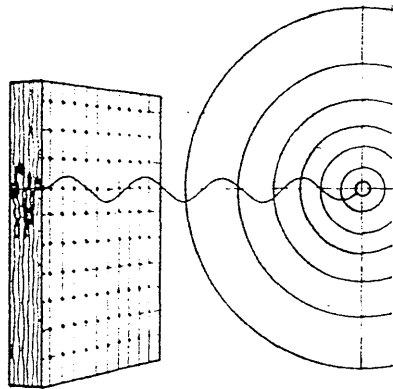
**standing wave**  
A wave in which the amplitude of the resultant of a transmitted and a reflected wave is fixed in time and ranges from zero at the nodes to a maximum at the antinodes.



**interference**  
The phenomenon in which two or more light or sound waves of the same frequency combine to reinforce or cancel each other, the amplitude of the resulting wave being equal to the algebraic or vector sum of the amplitudes of the combining waves.

**white noise**  
An unvarying, unobtrusive sound having the same intensity for all frequencies of a given band, used to mask or obliterate unwanted sound. Also called white sound.

**background noise**  
The sound normally present in an environment, usually a composite of sounds from both exterior and interior sources, none of which are distinctly identifiable by the listener. Also called ambient sound.



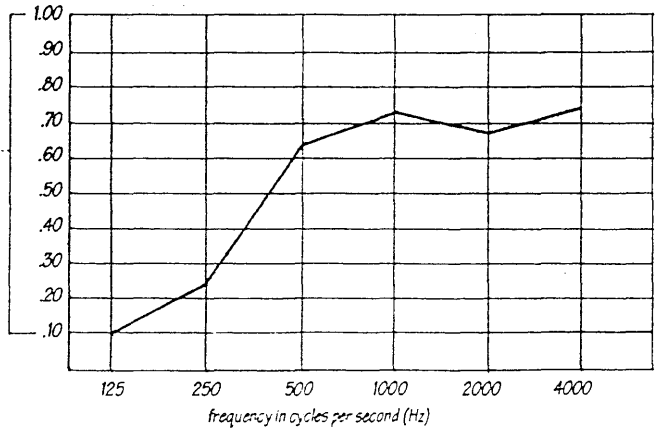
**absorption**  
The interception and conversion of sound energy into heat or other form of energy by the structure of a material, measured in sabins or absorption units.

**sabin**  
A unit of sound absorption, equal to one sq. ft. (0.09 sq. m) of a perfectly absorptive surface.

**metric sabin**  
A unit of sound absorption, equal to 1 square meter of perfectly absorptive surface. Also called absorption unit.

**absorption coefficient**  
A measure of the efficiency of a material in absorbing sound at a specified frequency, equal to the fractional part of the incident sound energy at that frequency absorbed by the material.

**noise reduction coefficient**  
A measure of the sound-absorbing efficiency of a material, equal to the average of the absorption coefficients of the material, computed to the nearest 0.05 at four frequencies: 250, 500, 1000, and 2000 Hz.



# SOUND

## sound isolation

The use of building materials and construction assemblies designed to reduce the transmission of airborne and structure-borne sound from one room to another or from the exterior to the interior of a building. Also called sound insulation.

## airborne sound transmission

Sound transmitted when a surface is set into vibration by the alternating air pressures of incident sound waves.

## structure-borne sound transmission

Sound transmitted through the solid media of a building's structure as a result of direct physical contact or impact, as by vibrating equipment or footsteps.

## transmission loss

A measure of the performance of a building material or construction assembly in preventing the transmission of airborne sound, equal to the reduction in sound intensity as it passes through the material or assembly when tested at all one-third octave band center frequencies from 125 to 4000 Hz expressed in decibels. Abbr.: TL

Three factors enhance the TL rating of a construction assembly: mass, separation into layers, and absorptive capacity.

## average transmission loss

A single-number rating of the performance of a building material or construction assembly in preventing the transmission of airborne sound, equal to the average of its TL values at nine test frequencies.

## sound transmission class

A single-number rating of the performance of a building material or construction assembly in preventing the transmission of airborne sound, derived by comparing the laboratory TL test curve for the material or assembly to a standard frequency curve. Abbr.: STC

The higher the STC rating, the greater the sound-isolating value of the material or construction. An open doorway has an STC rating of 10; normal construction has STC ratings from 30 to 60; special construction is required for STC ratings above 60.

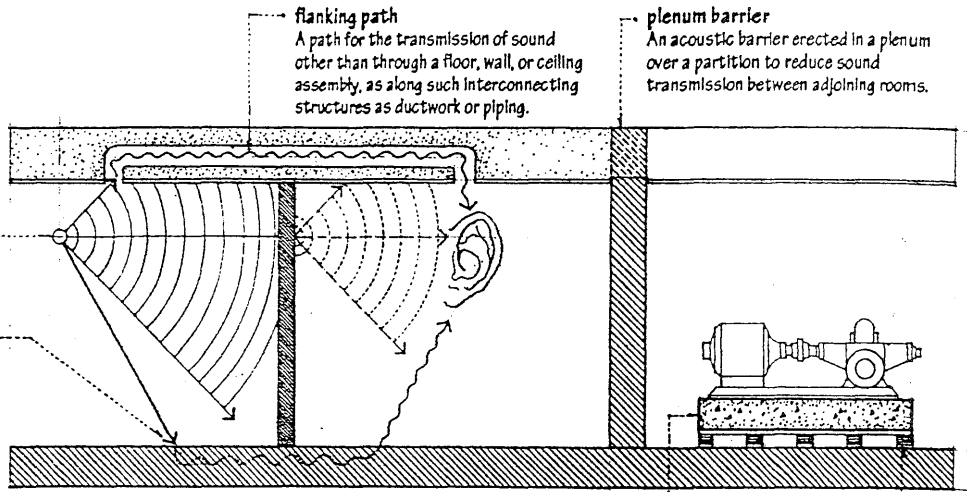
## impact noise

Structure-borne sound generated by physical impact, as by footsteps or the moving of furniture.

## Impact insulation class

A single-number rating of the performance of a floor-ceiling construction in preventing the transmission of impact noise. Abbr.: IIC

The higher the IIC rating, the more effective is the construction in isolating impact noise. The IIC rating replaces the previously used Impact Noise Rating (INR) and is approximately equal to the INR rating +51 dB for a given construction.



## flanking path

A path for the transmission of sound other than through a floor, wall, or ceiling assembly, as along such interconnecting structures as ductwork or piping.

## plenum barrier

An acoustic barrier erected in a plenum over a partition to reduce sound transmission between adjoining rooms.

## acoustic mass

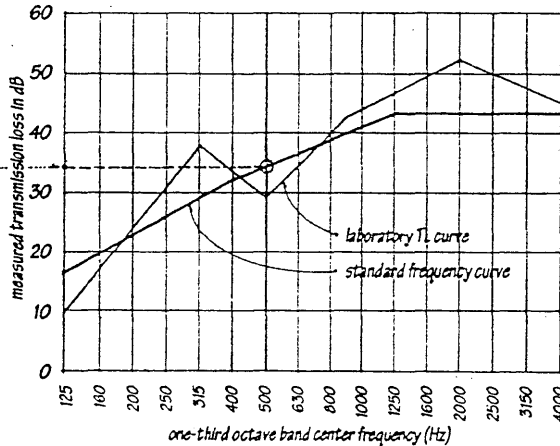
Resistance to the transmission of sound caused by the inertia and elasticity of the transmitting medium. In general, the heavier and more dense a body, the greater its resistance to sound transmission.

## vibration isolator

A resilient base for mechanical equipment, installed to reduce the transmission of vibration and noise to the supporting structure. Also called isolation mount.

## inertia block

A heavy concrete base for vibrating mechanical equipment, used in conjunction with vibration isolators to increase the mass of the equipment and decrease the potential for vibratory movement.



## discontinuous construction

Any of several construction methods, as the use of staggered studs or resilient mountings, for breaking the continuity of a path through which structure-borne sound may be transmitted from one space to another.

## staggered-stud partition

A partition for reducing sound transmission between rooms, framed with two separate rows of studs arranged in zigzag fashion and supporting opposite faces of the partition, sometimes with a fiberglass blanket between.

## resilient mounting

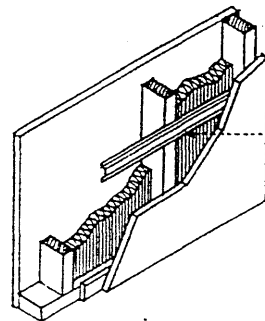
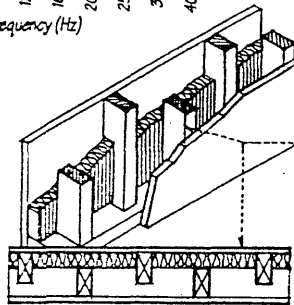
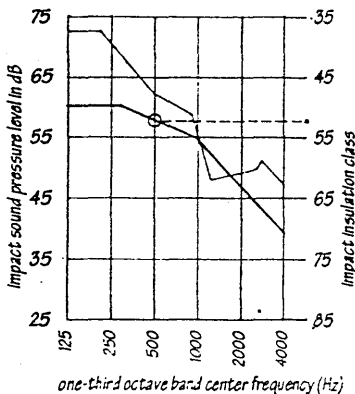
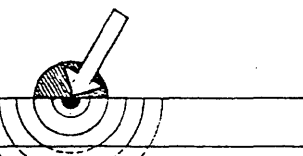
A system of flexible attachments or supports that permits room surfaces to vibrate normally without transmitting the vibratory motions and associated noise to the supporting structure.

## resilient channel

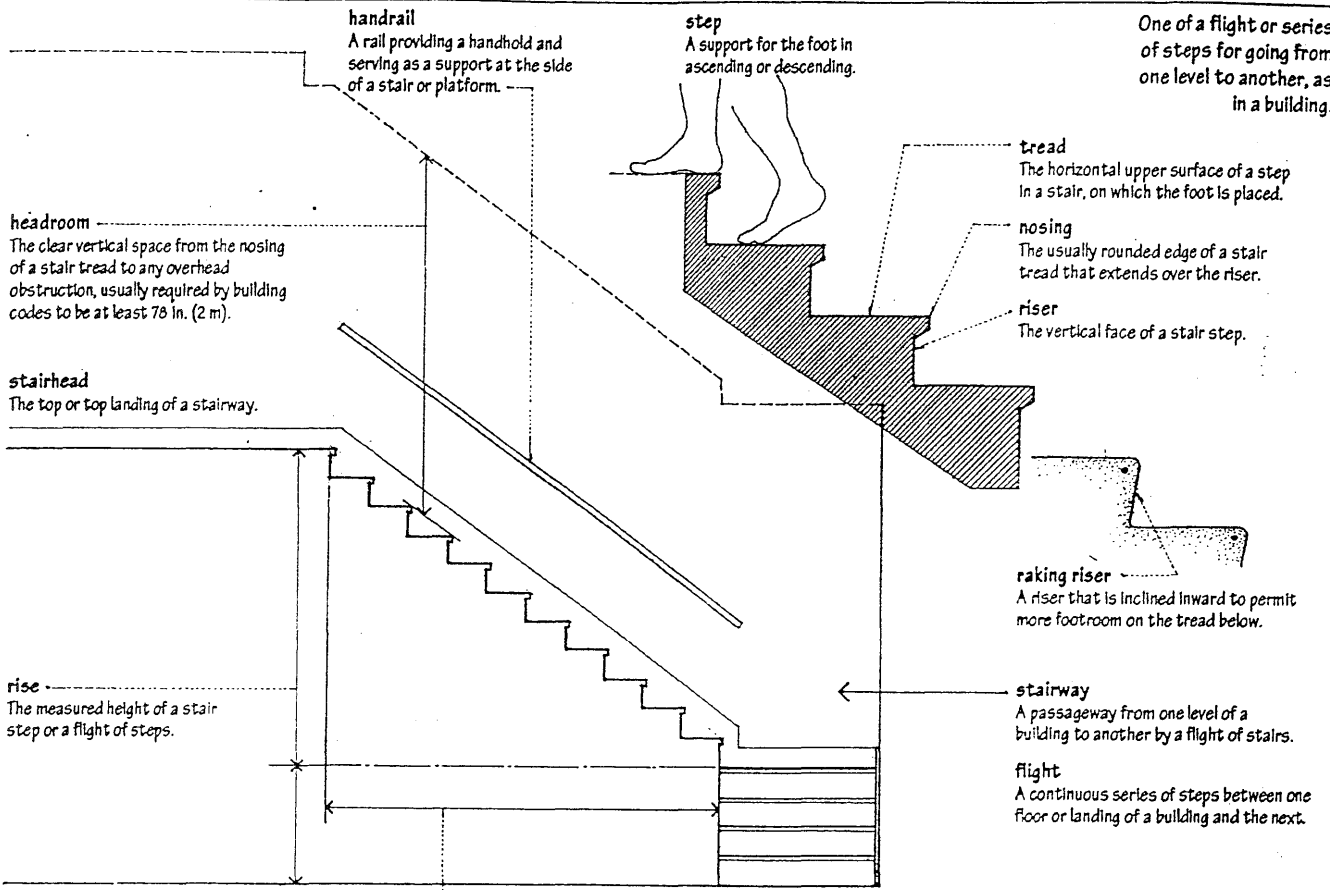
A metal channel for the resilient mounting of wallboard to studs or joists, used in sound-isolating construction to reduce the transmission of vibrations and noise.

## resilient clip

A flexible metal device for the resilient mounting of wallboard or metal lath to studs or joists, used in sound-isolating construction to reduce the transmission of vibrations and noise.



One of a flight or series of steps for going from one level to another, as in a building.



**stairwell**  
A vertical shaft or opening containing a stairway.

**ladder**  
A structure of wood, metal, or rope, usually consisting of two sidepieces joined at suitable intervals by bars or rungs, forming a means of climbing up or down at an angle of pitch between 75° and 90°.

**rung**  
One of the crosspieces, usually rounded, forming the steps of a ladder.

**ship's ladder**  
A fixed stepladder having an angle of pitch between 55° and 70°, usually equipped with handrails.

**run**  
The horizontal distance between successive risers or between the first and last risers of a flight of steps.

**critical angle**  
The angle of pitch above which a stair is considered to be uncomfortable or unsafe, usually 50°.

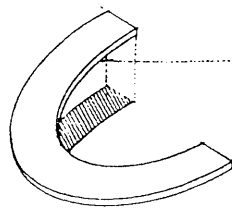
**riser:tread ratio**  
The preferred ratio between the riser and tread of a stairstep, specified by either of two formulas:  
 $R + 2T = 24 \text{ to } 25$ ;  
 $R \times T = 72 \text{ to } 75$ .

**preferred angle**  
For a flight of stairs, any angle of pitch between 28° and 36°; or, for a ramp, an angle of pitch less than 5°.

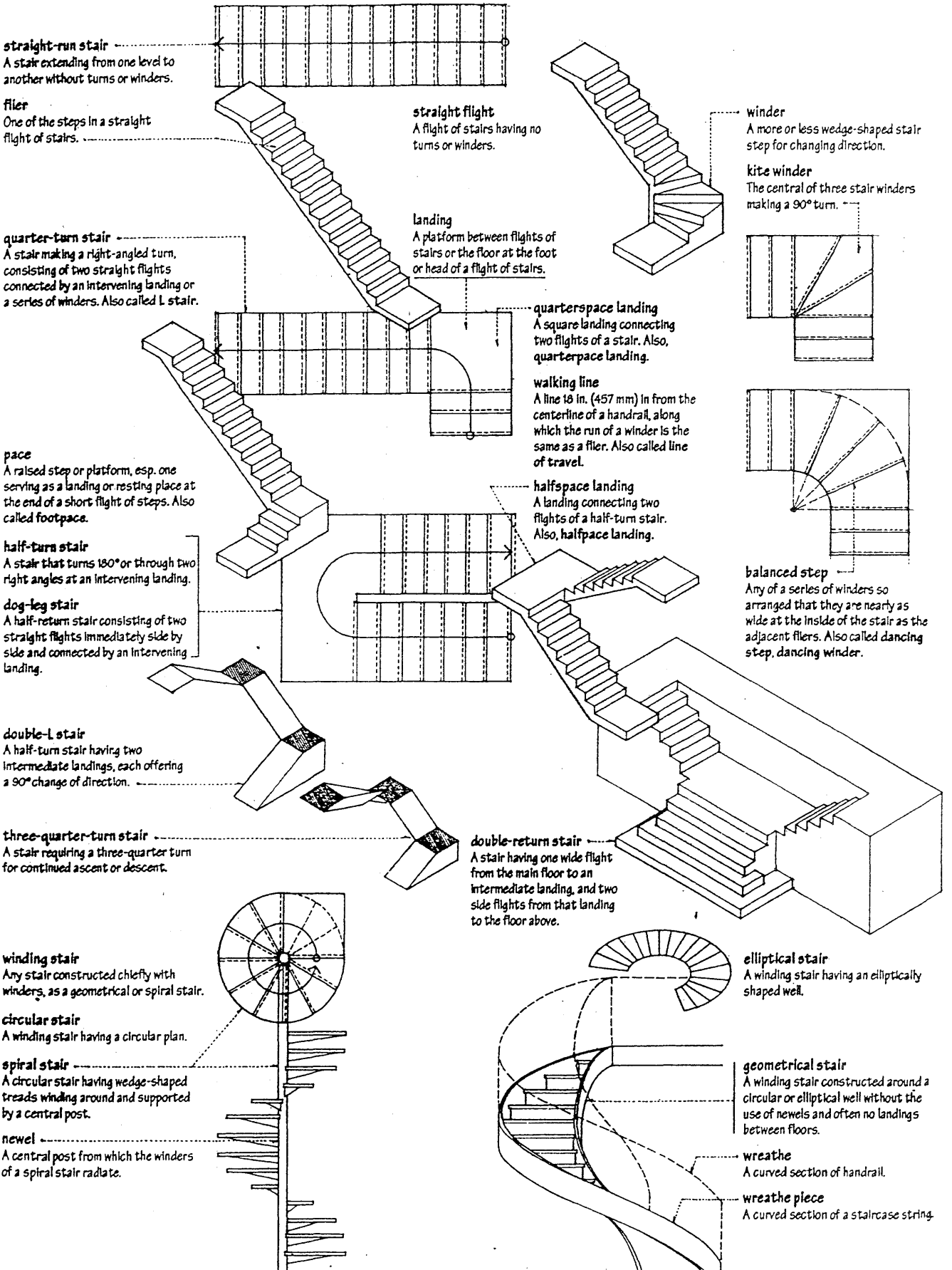
**ramp**  
A sloping floor, walk, or roadway connecting two levels.

**stepped ramp**  
A series of ramps connected by steps.

**helicline**  
A curved ramp.



# STAIR



**straight-run stair**  
A stair extending from one level to another without turns or winders.

**fler**  
One of the steps in a straight flight of stairs.

**straight flight**  
A flight of stairs having no turns or winders.

**winder**  
A more or less wedge-shaped stair step for changing direction.

**quarter-turn stair**  
A stair making a right-angled turn, consisting of two straight flights connected by an intervening landing or a series of winders. Also called L stair.

**landing**  
A platform between flights of stairs or the floor at the foot or head of a flight of stairs.

**kite winder**  
The central of three stair winders making a 90° turn.

**quarterspace landing**  
A square landing connecting two flights of a stair. Also, quarterspace landing.

**walking line**  
A line 18 in. (457 mm) in from the centerline of a handrail, along which the run of a winder is the same as a fler. Also called line of travel.

**pace**  
A raised step or platform, esp. one serving as a landing or resting place at the end of a short flight of steps. Also called footpace.

**half-turn stair**  
A stair that turns 180° or through two right angles at an intervening landing.

**halfspace landing**  
A landing connecting two flights of a half-turn stair. Also, halfspace landing.

**dog-leg stair**  
A half-return stair consisting of two straight flights immediately side by side and connected by an intervening landing.

**balanced step**  
Any of a series of winders so arranged that they are nearly as wide at the inside of the stair as the adjacent flers. Also called dancing step, dancing winder.

**double-L stair**  
A half-turn stair having two intermediate landings, each offering a 90° change of direction.

**double-return stair**  
A stair having one wide flight from the main floor to an intermediate landing, and two side flights from that landing to the floor above.

**three-quarter-turn stair**  
A stair requiring a three-quarter turn for continued ascent or descent.

**winding stair**  
Any stair constructed chiefly with winders, as a geometrical or spiral stair.

**elliptical stair**  
A winding stair having an elliptically shaped well.

**circular stair**  
A winding stair having a circular plan.

**spiral stair**  
A circular stair having wedge-shaped treads winding around and supported by a central post.

**geometrical stair**  
A winding stair constructed around a circular or elliptical well without the use of newels and often no landings between floors.

**newel**  
A central post from which the winders of a spiral stair radiate.

**wreath**  
A curved section of handrail.

**wreath piece**  
A curved section of a staircase string.

**string**  
One of the sloping boards running alongside a staircase to support or cover the ends of the treads and risers. Also called stringboard, stringer.

**wall string**  
A stair string set against a wall, usually notched or housed.

**carriage**  
An inclined beam for supporting the steps of a stair. Also called horse, rough stringer.

**box stair**  
A stair having a housed string on both sides so that it may be more or less completely finished before being set in its final location.

**housed string**  
A stair string receiving the ends of risers and treads in a series of housings. Also called closed string.

**apron piece**  
A header receiving the ends of stair carriages, strings, and the joists of landings. Also called pitching piece.

**kick plate**  
A plate for anchoring and absorbing the thrust of an inclined member, as a stair carriage.

**railing**  
A barrier composed of one or more horizontal rails supported by spaced uprights or balusters.

**stanchion**  
An upright post or support, as in a window or railing.

**balustrade**  
A railing with supporting balusters.

**baluster**  
Any of a number of closely spaced supports for a railing. Also called banister.

**newel drop**  
An ornamental, downward projection of a newel post, often through a soffit.

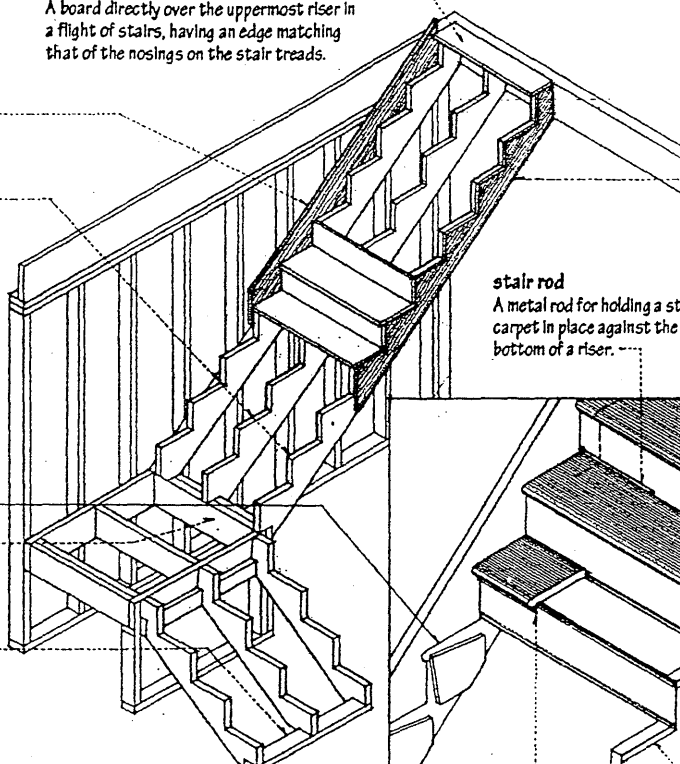
**safety nosing**  
A nosing having an abrasive, nonslip surface flush with the tread surface.

**safety tread**  
A tread having a roughened surface to prevent slipping.

**waist**  
The least thickness of a reinforced-concrete stair slab.

**hanging step**  
A step projecting from a wall with no real or apparent support at its outer end. Also called cantilevered step.

**landing tread**  
A board directly over the uppermost riser in a flight of stairs, having an edge matching that of the nosings on the stair treads.



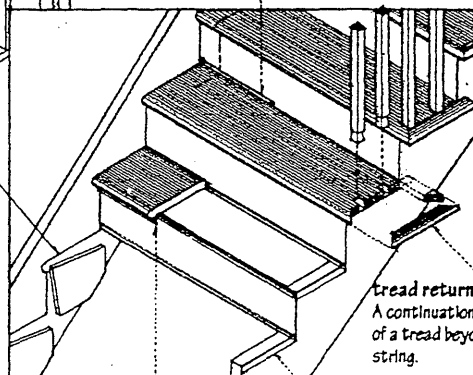
**staircase**  
A flight or series of flights of stairs, including its supporting framework, casing, and handrails.

**open-string stair**  
A stair having an open string on one or both sides.

**open string**  
A staircase string having its upper edge cut to the profile of the treads and risers. Also called cut string.

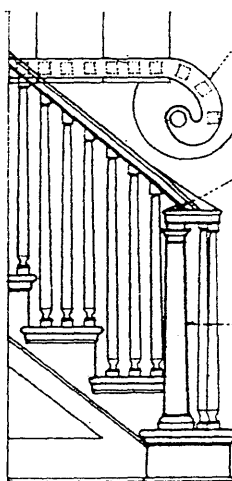
**face string**  
The outer string of a staircase, usually of better material or finish than the carriage which it covers. Also called finish string.

**stair rod**  
A metal rod for holding a stair carpet in place against the bottom of a riser.



**bracket**  
An ornamental piece filling the angle between a riser and the overhanging edge of its tread.

**cut-and-mitered string**  
An open string having the vertical edges of the notches mitered with the ends of the stair risers.



**curtail**  
A horizontal, spiral termination to the lower end of a stair rail. Also called volute.

**curtail step**  
A starting step having a scroll termination to one or both ends of the tread.

**newel cap**  
The terminal feature of a newel post, often molded or turned in a decorative manner.

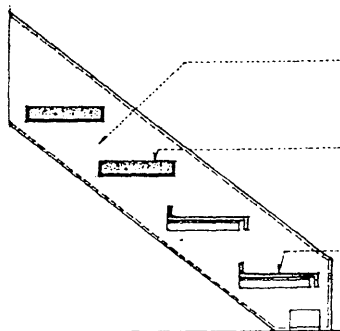
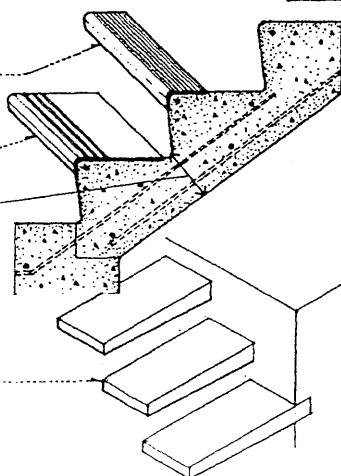
**newel**  
A post supporting one end of a handrail at the top or bottom of a flight of stairs. Also called newel post.

**open-riser stair**  
A stair having open spaces between successive treads, allowing light to pass from above.

**open riser**  
An open space between two successive treads.

**pan tread**  
A steel pan receiving a concrete fill and serving as a tread or as a combined tread and riser.

**plate tread**  
A tread fabricated from metal plate, usually having a raised pattern to provide a nonslip surface.

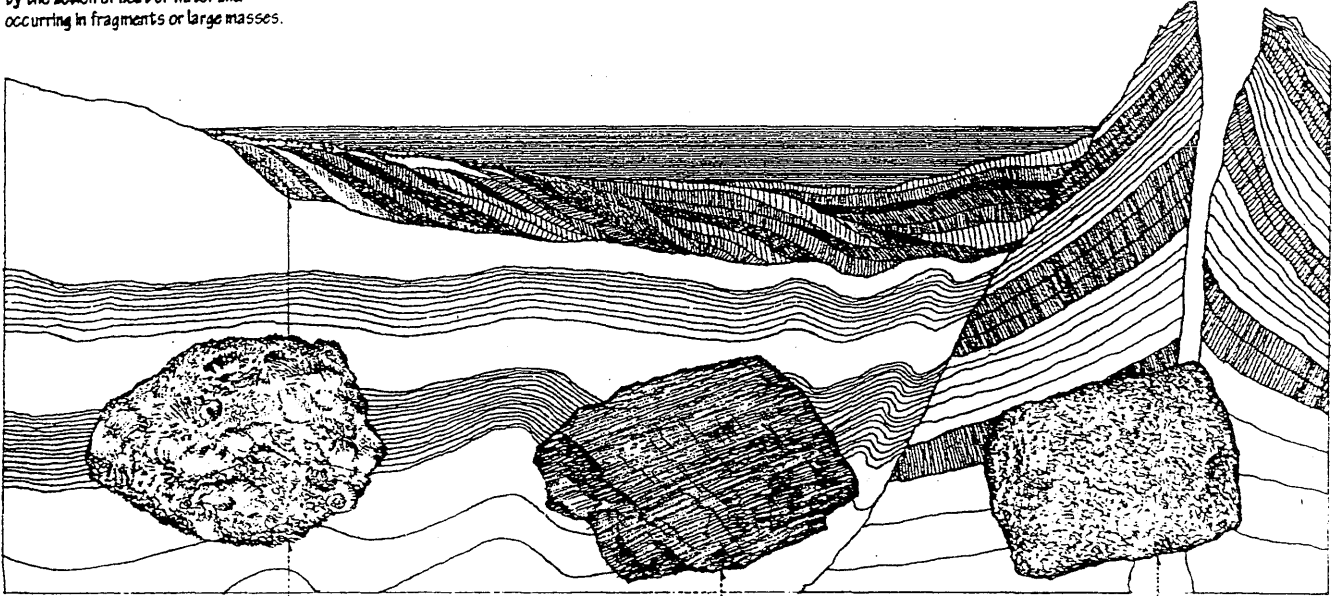


# STONE

Rock or a piece of rock quarried and worked into a specific size and shape for a particular purpose.

## rock

Solid mineral matter, naturally formed by the action of heat or water and occurring in fragments or large masses.



## sedimentary rock

A class of rock formed by the deposition of sediment, as limestone, sandstone or shale.

### limestone

A sedimentary rock formed chiefly by the accumulation of organic remains, as shells and coral, consisting mainly of calcium carbonate, and used as a building stone and in the manufacture of lime.

### travertine

A variety of limestone deposited by spring waters, esp. hot springs, sold as marble in the building trade.

### dolomite

A limestone rich in magnesium carbonate.

### oolite

A limestone composed of small, round, calcareous grains resembling fish roe. Also called egg stone.

### sandstone

A sedimentary rock consisting of sand, usually quartz, cemented together by various substances, as silica, clay, or calcium carbonate.

### bluestone

A dense, fine-grained, argillaceous sandstone that splits easily along bedding planes to form thin slabs.

### brownstone

A reddish-brown sandstone quarried and used extensively as a building material.

### soapstone

A massive, soft rock containing a high proportion of talc, used as dimension stone for hearths, table tops, and carved ornaments. Also called steatite.



## metamorphic rock

A class of rock that has undergone a change in structure, texture, or composition due to natural agencies, as heat and pressure, esp. when the rock becomes harder and more crystalline.

### marble

A metamorphic rock of crystallized limestone, consisting mainly of calcite or dolomite, capable of taking a high polish, and used esp. in architecture and sculpture. The presence and distribution of numerous minerals account for the distinctive variegated appearance that many marbles have. The commercial term includes many dense limestones and some coarse-grained dolomites.

### verd antique

A dark-green, mottled serpentine that takes a high polish and is sold as a marble. Also, verde antique.

### slate

A dense, fine-grained metamorphic rock formed by the compression of various sediments, as clay or shale, having good cleavage along parallel planes.

### quartzite

A compact, granular metamorphic rock consisting essentially of quartz, derived from sandstone.

### gneiss

A banded or foliated metamorphic rock corresponding in composition to granite, in which the minerals are arranged in layers.



### granite

A very hard, coarse-grained igneous rock composed mainly of quartz, feldspar, and mica or other colored minerals.

### obsidian

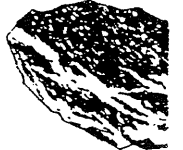
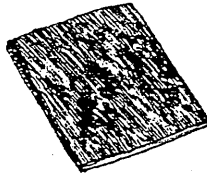
A volcanic glass similar in composition to granite, usually black with a bright luster, and transparent in thin pieces.

### malachite

A green to nearly black mineral, copper carbonate, used as a highly polished veneer and for making ornamental articles.

### serpentine

A mineral or rock consisting of hydrous magnesium silicate, usually green in color and having a mottled appearance.





**grain**  
The granular texture or appearance of a stone.

**bedding plane**  
The surface that separates one stratum or layer of stratified rock from another.

**cleavage plane**  
A relatively smooth surface along which certain rocks will tend to split.

**split-faced**  
Noting a rough stone finish produced by splitting to expose the bedding planes.

**freestone**  
Any fine-grained stone, as limestone or sandstone, that can be quarried or worked easily, esp. one that cuts well in all directions.

**carved work**  
Hand-cut ornamental features in brick or stone masonry.

**cast stone**  
A hardened mix of concrete with a fine stone aggregate, having a surface ground, polished, or molded to simulate natural stone.

**cut stone**  
Building stone cut or machined to a relatively fine finish.

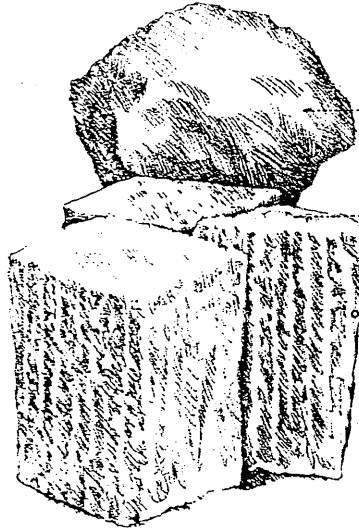
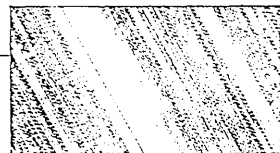
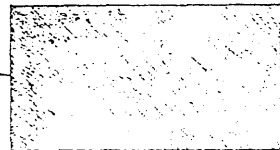
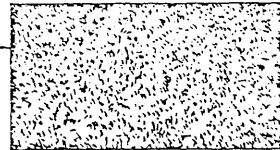
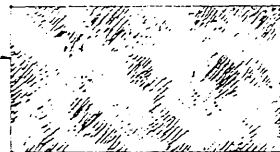
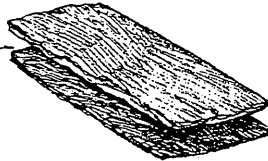
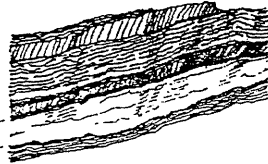
**chat-sawn**  
Noting a coarse, pebbled stone finish produced by using a slurry of a loose abrasive and water in the sawing process.

**shot-sawn**  
Noting a pebbled or rippled stone finish produced by using a slurry of water and hardened steel pellets in the sawing process.

**flame finish**  
A textured stone finish produced by superheating the surface so as to cause small chips to split off. Also called thermal finish.

**honed finish**  
A smooth stone finish having little or no gloss, obtained by rubbing with an abrasive.

**polished work**  
A stone face of crystalline texture, as of marble or granite, ground and buffed to form a glasslike surface. Also called glassed surface.



**building stone**  
Any stone suitable for use in building construction, as limestone, marble, or granite.

**fieldstone**  
Loose, unfinished stone found on the surface or in the soil, esp. when used for building, as in dry masonry.

**dimension stone**  
Quarried and squared stone 2 ft. (610 mm) or more in length and width and of specified thickness.

**dressed stone**  
Stone worked to desired shape and smoothed on the face.

**pitch-faced**  
Noting a stone having all arrises cut in the same plane and the faces roughly dressed with a pick.

**draft**  
A line or border chiseled at the edge of a stone to guide the stonecutter in leveling the surfaces.

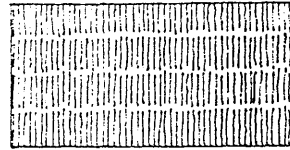
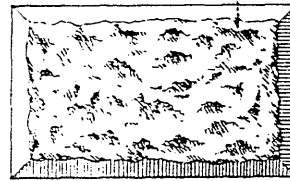
**drafted margin**  
A smooth, uniform margin worked around a stone face.

**sunk draft**  
A margin of a stone set below the rest of the face.

**quarry-faced**  
Of or pertaining to a stone or stonework the visible face of which is dressed with a hammer. Also, rock-faced.

**boasted surface**  
A stone finish obtained by chiselling roughly parallel grooves across the face.

**batted surface**  
A scored stone surface made with a mason's chisel after the surface has been rubbed smooth. Also called tooled surface.

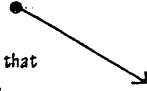


# STRUCTURE

**A stable assembly of structural elements designed and constructed to function as a whole in supporting and transmitting applied loads safely to the ground without exceeding the allowable stresses in the members.**

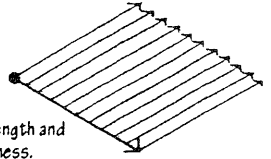
## linear structure

A structural member having a length that dominates its other two dimensions.



## surface structure

A structural member having a length and width that dominates its thickness.



## rigid

Of or pertaining to a structure or structural member having a shape that does not change appreciably under the action of an applied load or changing loads.

## bulk-active structure

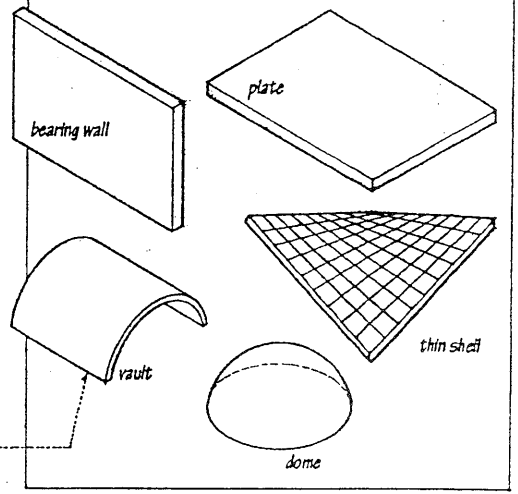
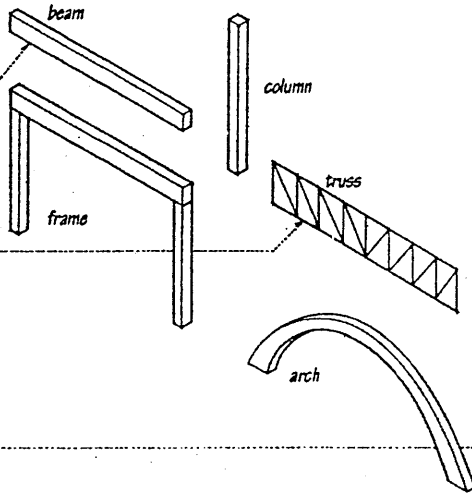
A structure or structural member that redirects external forces primarily through the bulk and continuity of its material, as a beam or column.

## vector-active structure

A structure that redirects external forces primarily through the composition of tension and compression members, as a truss.

## surface-active structure

A structure that redirects external forces primarily along the continuity of a surface, as a plate or shell.

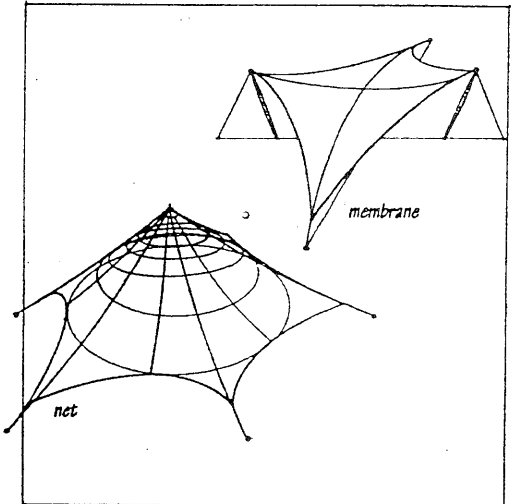
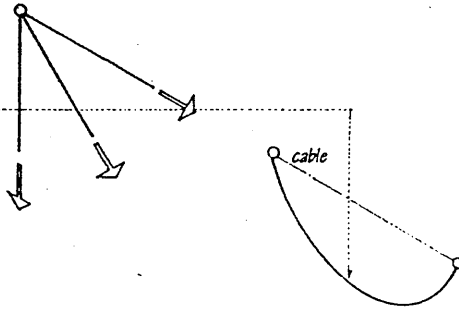


## flexible

Of or pertaining to a structure or structural member characterized by a lack of stiffness and having a shape that responds to changes in loading.

## form-active structure

A structure or structural member that redirects external forces primarily through the form of its material, as an arch or cable.

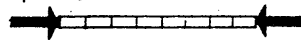


## structural member

One of the constituent parts into which a structure may be resolved by analysis, having a unitary character and exhibiting a unique behavior under an applied load.

## compression member

A structural member subject primarily to compressive forces.

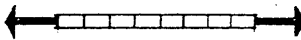


## strut

A structural member designed primarily to resist longitudinal compression.

## tension member

A structural member subject primarily to tensile forces.

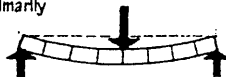


## tie

A tension member designed to keep two structural members from spreading or separating.

## bending member

A structural member subject primarily to transverse forces.

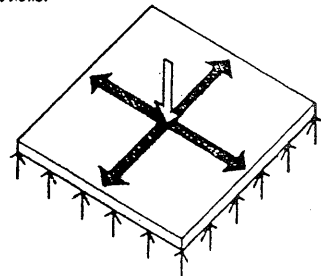
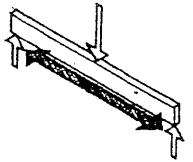


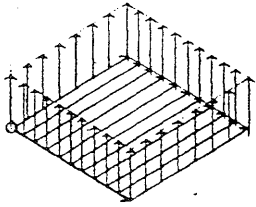
## one-way

Of or pertaining to a structure or structural member having a load-carrying mechanism that acts in one direction only.

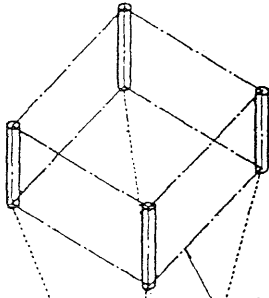
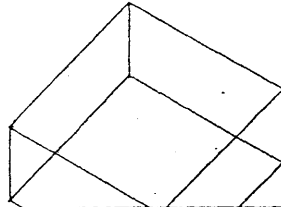
## two-way

Of or pertaining to a structure or structural member having a load-carrying mechanism that acts in two or more directions.

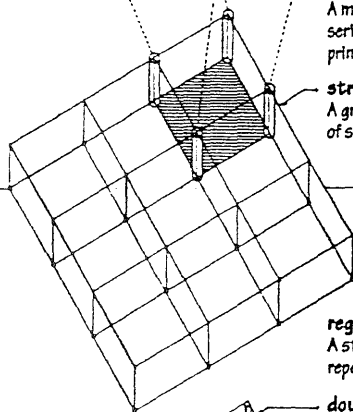
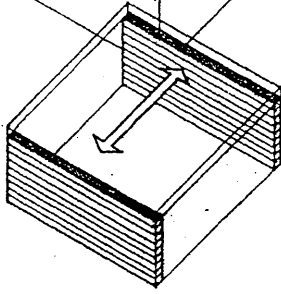
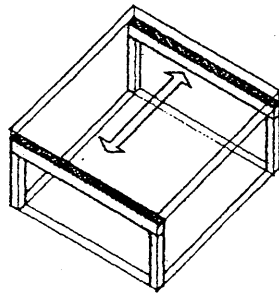




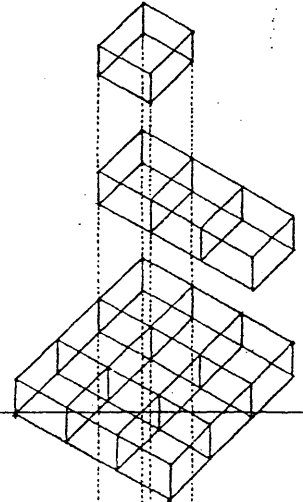
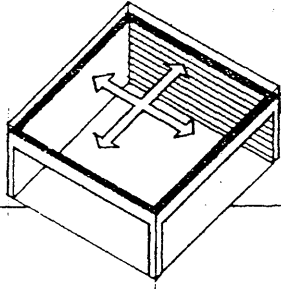
**structural unit**  
A discrete structure or assembly of structural members forming a spatial volume.



**bay**  
A major spatial division, usually one of a series, marked or partitioned off by the principal vertical supports of a structure.



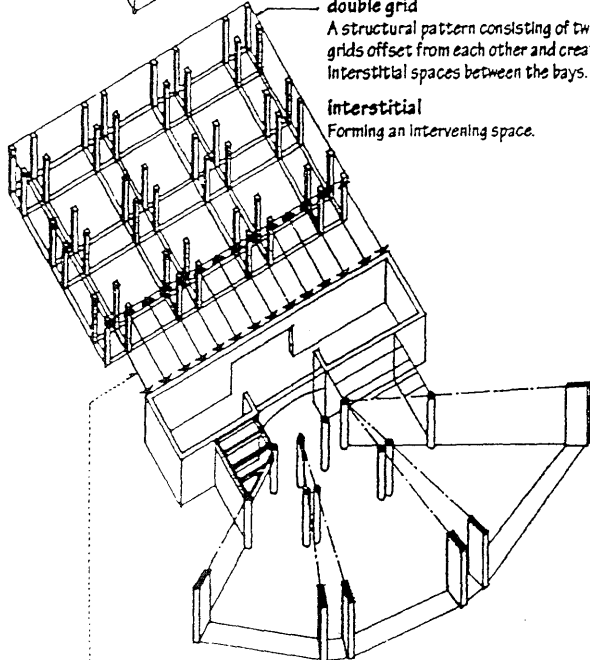
**structural grid**  
A grid defining the principal points or lines of support for a structural system.



**regular grid**  
A structural grid having regularly repeating bays in two directions.

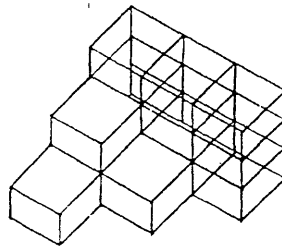
**double grid**  
A structural pattern consisting of two grids offset from each other and creating interstitial spaces between the bays.

**interstitial**  
Forming an intervening space.



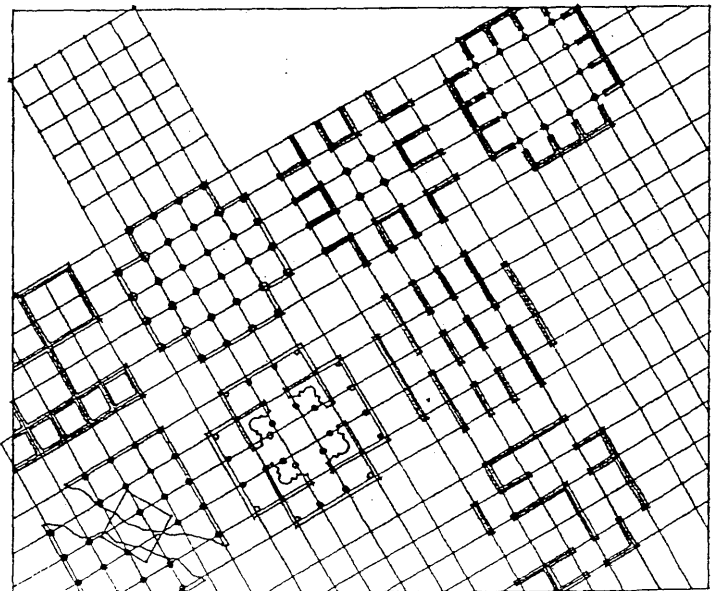
**transition structure**  
A structure mediating between two or more different structural patterns.

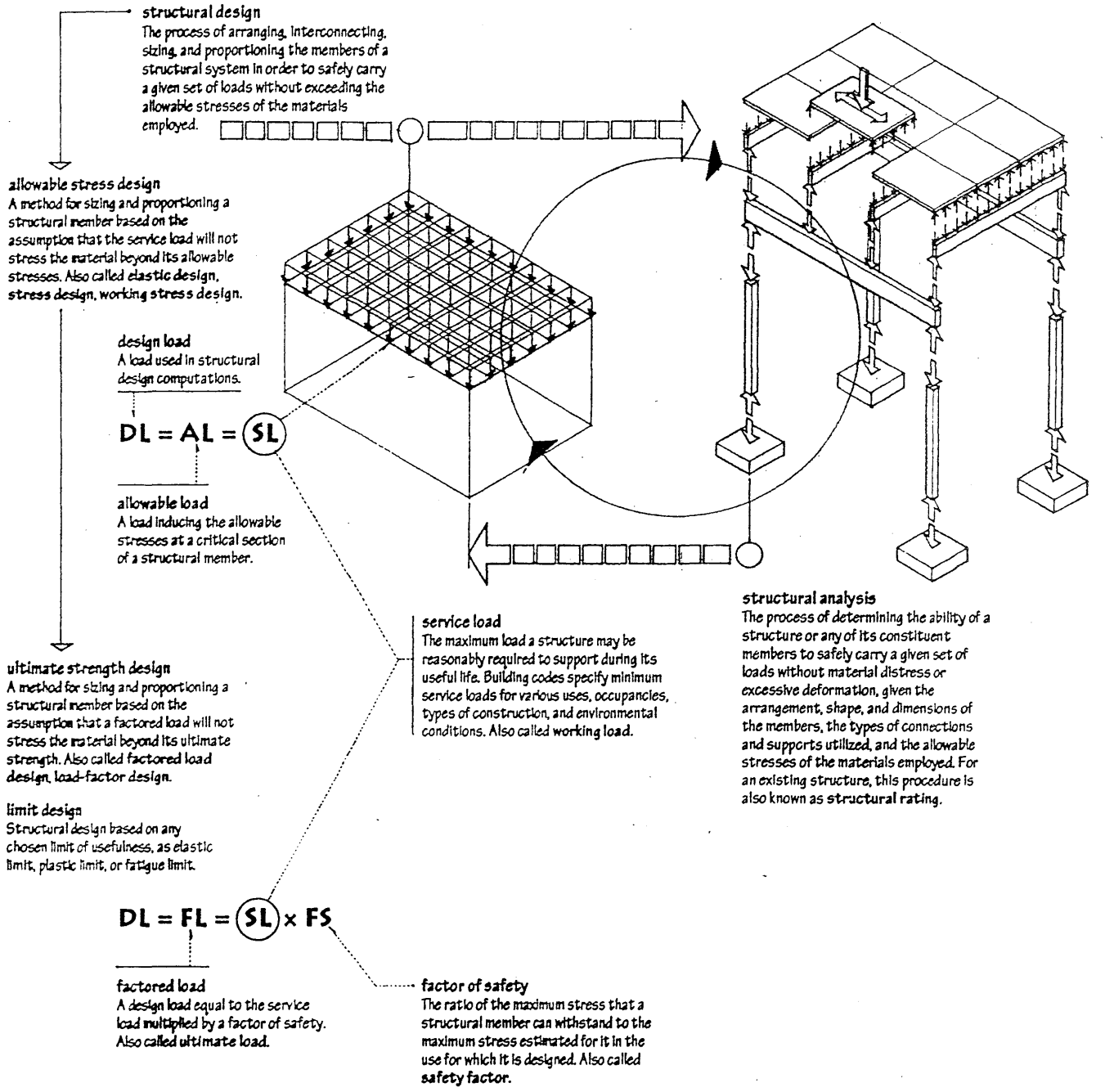
**irregular grid**  
A structural grid having irregularly shaped bays in one or more directions.



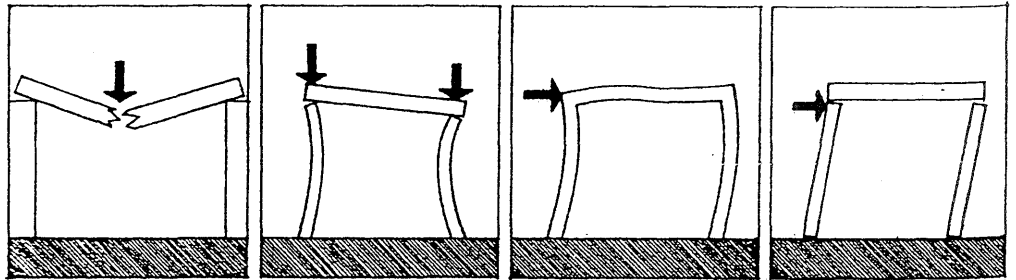
**slipped grid**  
A structural grid having points or lines of supports spaced uniformly in one direction but varying in the other.

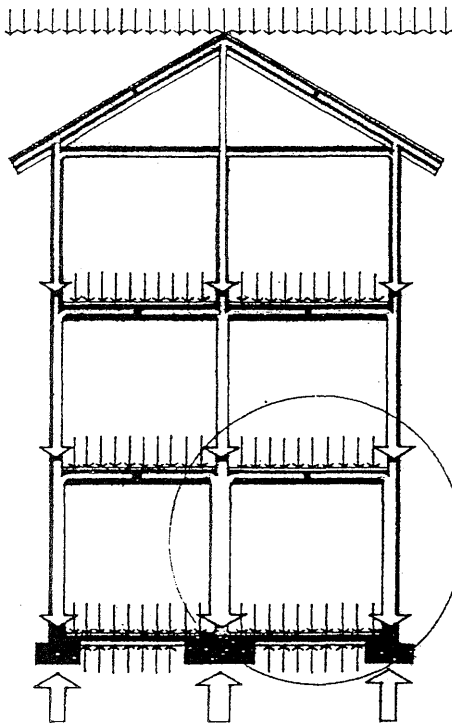
**structural pattern**  
The arrangement of principal vertical supports for a structure, which influences the selection of an appropriate spanning system and establishes the possibilities for the ordering of spaces and functions.



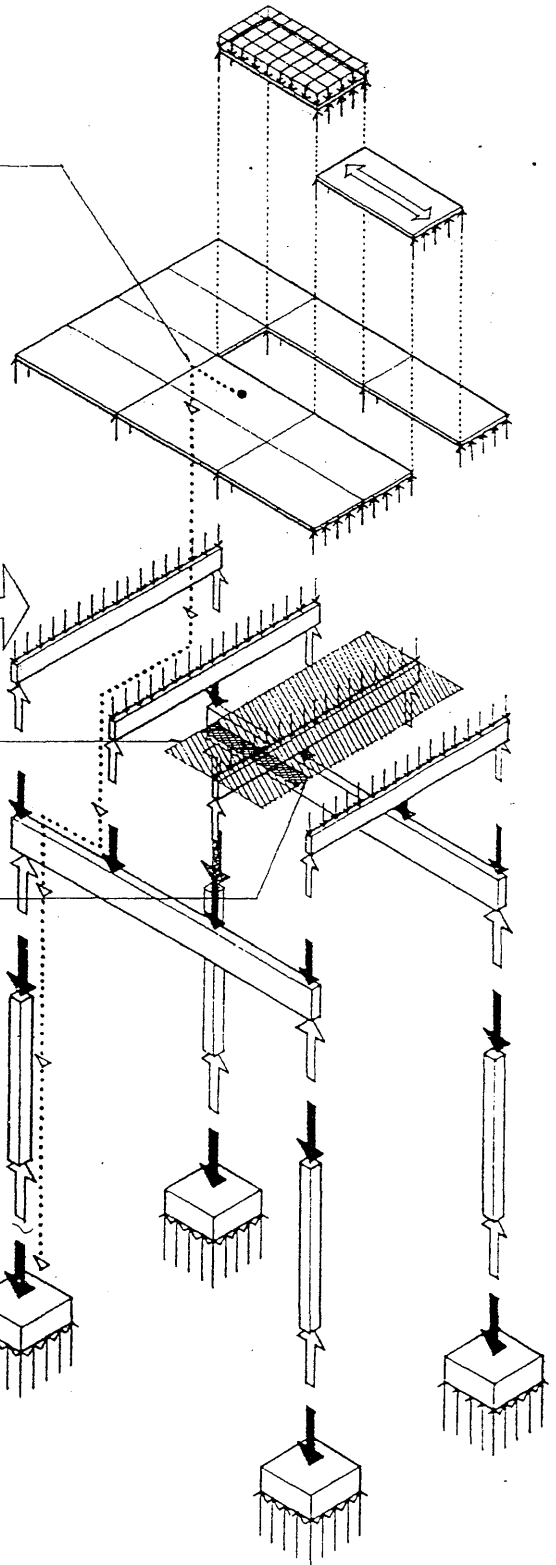


**structural failure**  
Any condition, as fracturing, buckling, or plastic deformation, that renders a structural assembly, element, or joint incapable of sustaining the load-carrying function for which it was designed.





**load trace**  
The process of modeling how a structure collects, channels, and redirects the loads resulting from external forces through the hierarchy of its members to the foundation and underlying soil. The analysis usually starts at the roof level with the smallest members actually picking up the loading and proceeds by tracing the loads through each collecting member. The reactions of each member to its loading becomes forces on the members supporting it. Also called load flow.

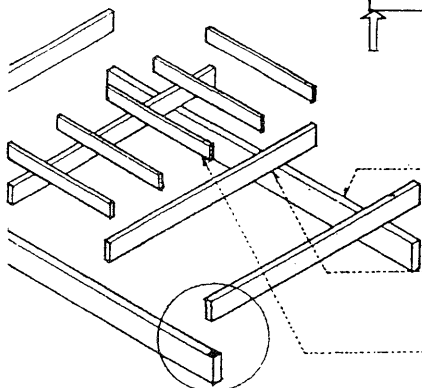


**tributary area**  
The portion of a structure contributing to the load on a structural element or member. Also called contributory area.

**tributary**  
Channeling into something more inclusive.

**tributary load**  
The load on a structural element or member collected from its tributary area.

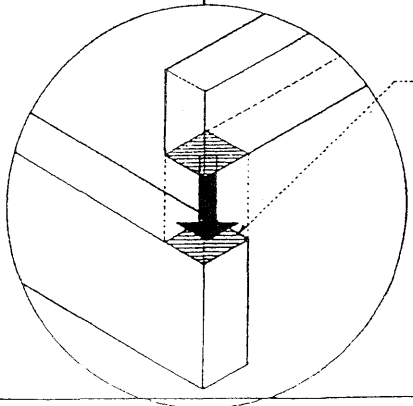
**load strip**  
The tributary area per unit length of a supporting structural member.



**primary member**  
A structural member essential to the stability of a structural whole. Also called main member.

**secondary member**  
Any structural member supported by a primary member.

**tertiary member**  
Any structural member supported by a secondary member.



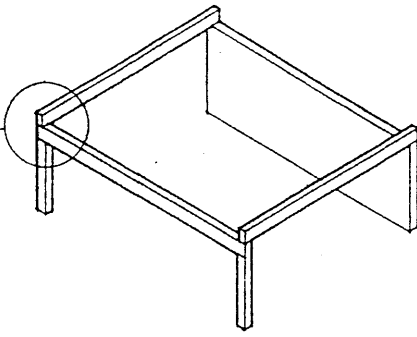
**bearing**  
A point, surface, or mass that supports weight, esp. the area of contact between a bearing member, as a beam or truss, and a column, wall, or other underlying support.

**bearing stress**  
The stress developed between a bearing member and an underlying support, equal to the quotient of the magnitude of the forces transmitted and the area of contact between the two elements.

# STRUCTURE

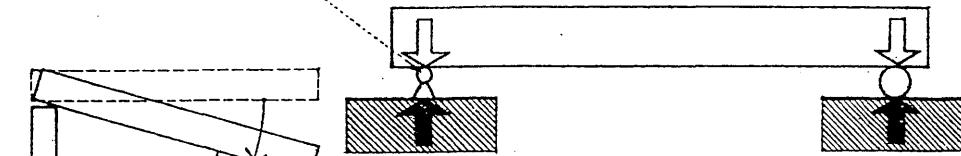
## support condition

The manner in which a structural member is supported and connected to other members, affecting the nature of the reactive forces developed on the loaded member.



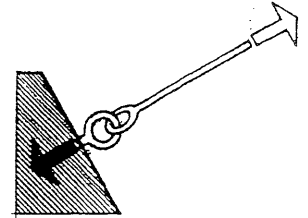
## point of support

A point on a structural member at which its reaction to a load is transmitted as a force to a supporting member.

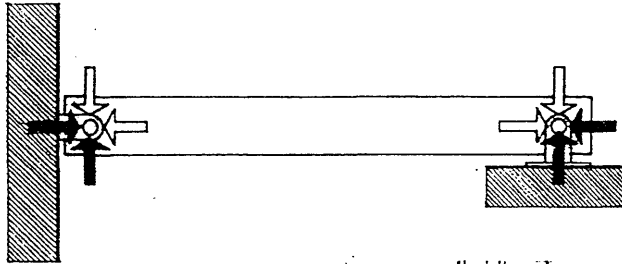
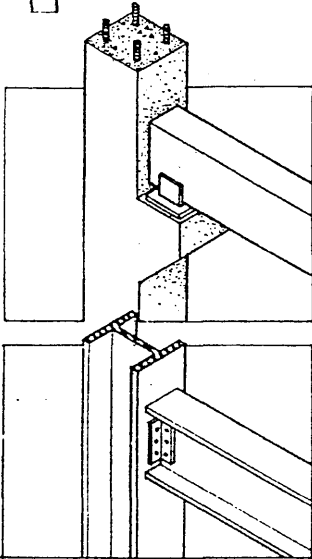


**unrestrained member**  
A structural member permitted to rotate freely about a point of support.

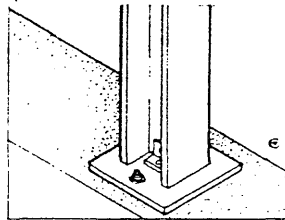
**roller support**  
A structural support that allows rotation but resists translation in a direction perpendicular into or away from its face. Also called roller joint.



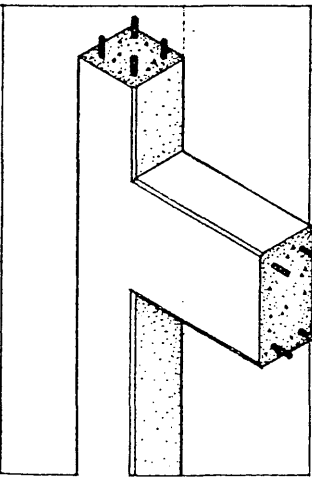
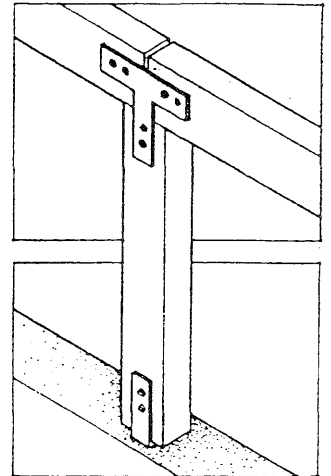
**cable support**  
A cable anchorage that allows rotation but resists translation only in the direction of the cable.



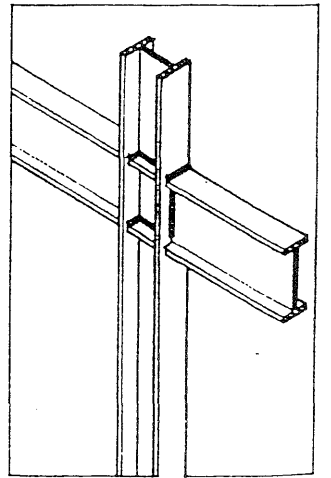
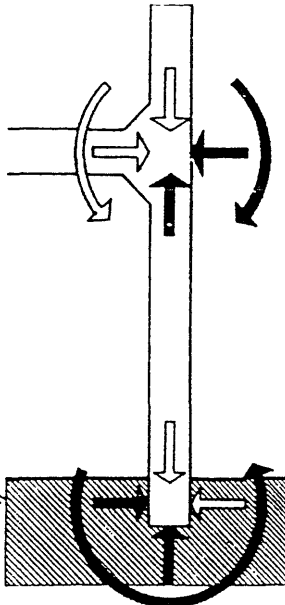
**pin joint**  
A structural connection that allows rotation but resists translation in any direction. Also called hinge joint, pinned connection.



**pin**  
A slender rod driven through holes in adjacent parts to keep the parts together or to permit them to move in one plane relative to each other.

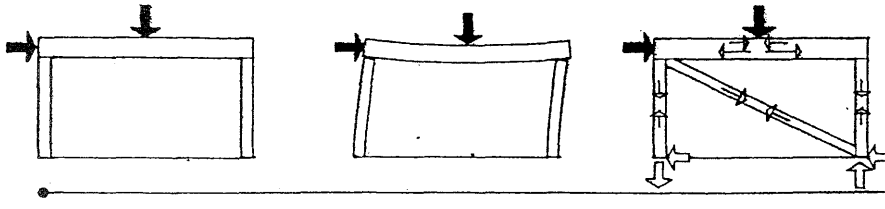


**rigid joint**  
A structural connection that maintains the angular relationship between the joined elements, restrains rotation and translation in any direction, and provides both force and moment resistance. Also called fixed connection, fixed joint, rigid connection.



**fixed-end connection**  
A rigid joint connecting the end of a structural member to a support.

**anchorage**  
A means for binding a structural member to another or to its foundation, often to resist uplifting and horizontal forces.



**stability**  
The ability of a structure, when disturbed from a condition of equilibrium by an applied load, to develop internal forces or moments that restore the original condition.

**lateral stability**  
The ability of a structure to resist lateral forces without sliding, overturning, buckling, or collapsing.

**racking**  
The straining and distortion of a structural frame by lateral forces.

**collapse mechanism**  
An unstable configuration of structural members susceptible to falling or breaking down under an applied load without a change in length of any individual member.

**lateral bracing**  
Stabilizing a structural system against lateral forces by means of diagonal or cross bracing.

**brace**  
A structural element for positioning, supporting, strengthening, or restraining the members of a structural frame.

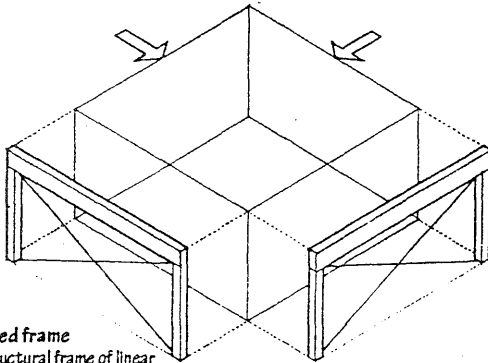
**diagonal bracing**  
A system of inclined members for bracing the angles between the members of a structural frame and ensuring the lateral stability of the whole.

**sway brace**  
A diagonal member for bracing a structure against lateral forces.

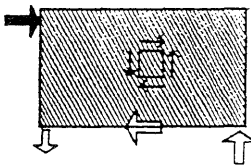
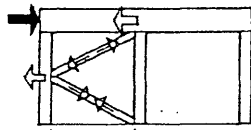
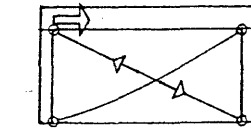
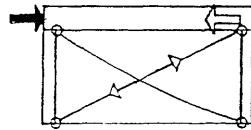
**cross bracing**  
A pair of transverse braces for stabilizing a structural frame against lateral forces. When using cables, two are necessary to stabilize the structure against lateral forces from either direction. For each direction, one cable will operate effectively in tension while the other would simply buckle. If rigid braces are used, a certain degree of redundancy is involved since a single member is capable of stabilizing the structure. Also, X-bracing.

**K-brace**  
A pair of diagonal braces for stabilizing a structural frame against lateral forces, meeting at some point along the length of a member of the frame.

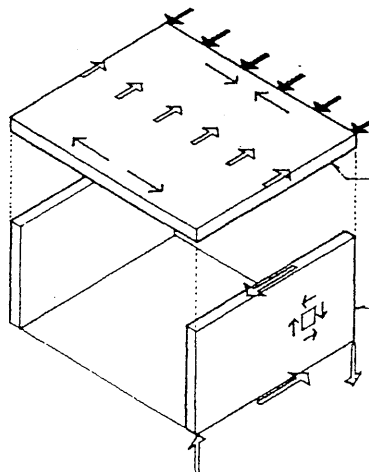
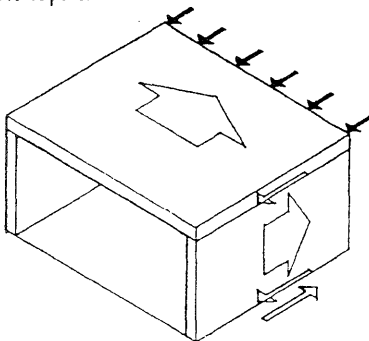
**knee brace**  
A diagonal member for bracing the angle between two joined members, being joined to each partway along its length.



**braced frame**  
A structural frame of linear members made rigid by a system of diagonal members.



**diaphragm**  
A relatively thin, rigid structural member capable of withstanding shear when loaded in a direction parallel to its plane.



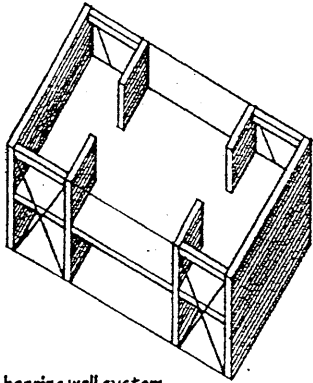
**horizontal diaphragm**  
A rigid floor or roof plane acting as a thin, deep beam in transferring lateral forces to vertical shear walls, braced frames, or rigid frames.

**shear wall**  
A vertical diaphragm acting as a thin, deep cantilever beam in transferring lateral loads to the ground foundation.

# STRUCTURE

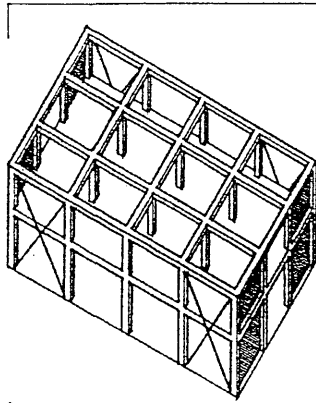
## regular structure

A structural system characterized by the symmetrical configuration of mass and lateral force-resisting elements and having no significant discontinuities of stiffness or strength. The effects of lateral forces on regular structures may be determined by static methods.



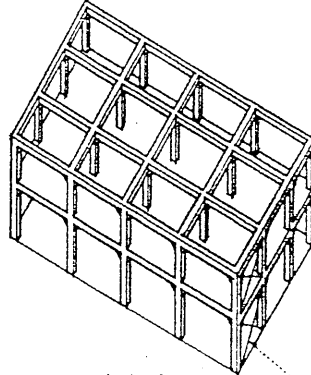
## bearing wall system

A structural system consisting of vertical planar elements for supporting gravity loads and shear walls or braced frames for resisting lateral forces.



## frame system

A structural system consisting of a three-dimensional array of interconnected linear members that functions as a complete, self-contained unit in supporting gravity loads and shear walls or braced frames for resisting lateral forces.



## moment-resisting frame

A frame system designed to resist lateral forces primarily by flexure in the members and joints.

## dual system

A structural system for resisting lateral forces, combining the ductility of a moment-resisting frame with the rigidity of a shear wall.

## eccentric bracing

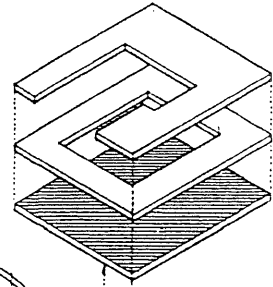
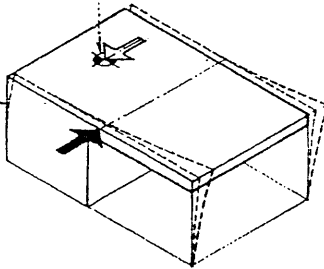
A structural system for resisting lateral forces, combining the ductility of a moment-resisting frame with the rigidity of a braced frame.

## irregular structure

A structural system characterized by any of various plan or vertical irregularities, as a soft or weak story, a discontinuous shear wall or diaphragm, or the asymmetrical layout of mass or lateral force resisting elements. Irregular structures generally require dynamic analysis in order to determine the torsional effects of lateral forces.

## center of resistance

The centroid of the vertical elements of a lateral force-resisting system, through which the shear reaction to lateral forces acts. Also called center of rigidity.

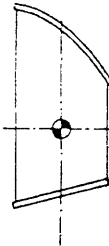


## discontinuous diaphragm

A horizontal diaphragm having a large cutout or open area, or a stiffness significantly less than that of the story above or below.

## torsional irregularity

The asymmetrical layout of mass or lateral force-resisting elements, resulting in noncoincident centers of mass and resistance and causing the story drift at one end of the structure to be more than the average of the story drifts at both ends.

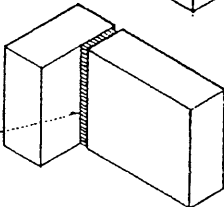
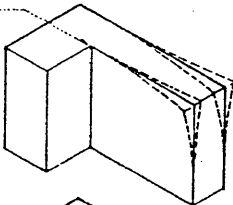


## nonparallel system

A structural system having lateral force-resisting elements neither parallel nor symmetrical about the major orthogonal axes of the system.

## reentrant corner

The plan configuration of a structure and its lateral force-resisting system having projections beyond a corner significantly greater than the plan dimension in the given direction. A reentrant corner tends to produce differential motions between different portions of the structure, resulting in local stress concentrations at the corner. Solutions include providing a seismic joint to separate the building into simpler shapes, tying the building together more strongly at the corner, or splicing the corner.



## seismic joint

A joint that physically separates two adjacent building masses so that free vibratory movement in each can occur independently of the other.

## soft story

A story having a lateral stiffness significantly less than that of the stories above.

## weak story

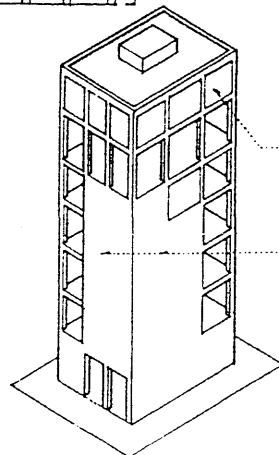
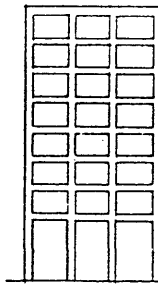
A story having lateral strength significantly less than that of the stories above.

## irregular mass

A story having an effective mass significantly greater than that of an adjacent story.

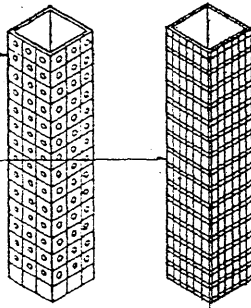
## discontinuous shear wall

A shear wall having a large offset or a significant change in horizontal dimension.





**perforated shell tube**  
A tube structure having perimeter shear walls with less than 30% of the surface area perforated by openings.

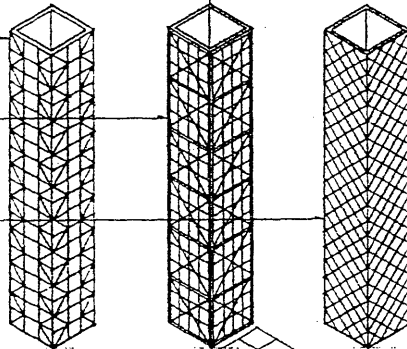


**framed tube**  
A tube structure having closely spaced perimeter columns rigidly connected by deep spandrel beams.

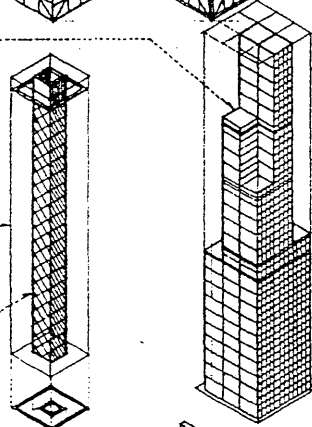
**braced tube**  
A framed tube structure tied together by a system of diagonal braces.

**trussed tube**  
A braced tube structure having trussed wall frames of widely spaced columns tied together by diagonal or cross bracing.

**latticed truss tube**  
A braced tube structure having perimeter frames of closely spaced diagonals with no vertical columns.

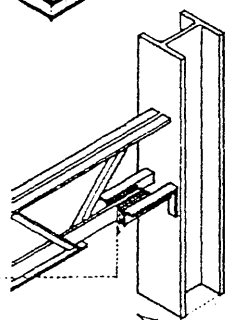


**bundled tubes**  
An assembly of narrow tubes tied directly to each other to form a modular structure that behaves like a multicellular box girder cantilevering out of the ground. More tubes are sometimes provided in the lower portion of a tall structure where greater lateral force resistance is needed.

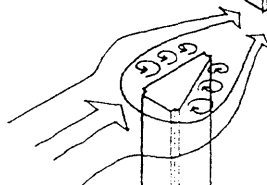


**tube-in-tube structure**  
A tube structure having an inner braced tube added to the perimeter tube to improve its shear stiffness in resisting lateral forces.

**braced core**  
An interior service core braced to provide additional stiffness in resisting lateral forces.

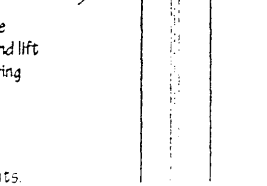


**internal damping**  
The damping that naturally occurs as a building undergoes elastic or plastic deformation, as from the internal friction of a stressed material (hysteresis damping), from the friction between two moving parts (frictional damping), or from the viscous resistance of a fluid such as air (viscous damping).

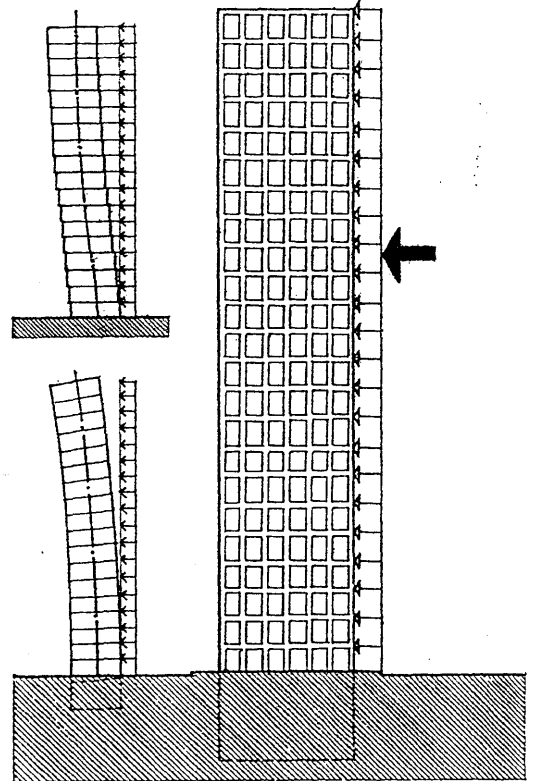


**aerodynamic damping**  
The shaping of a tall building to create turbulence which generates cross-wind lift to oppose cross-wind deflections during high winds.

**turbulence**  
Irregular motion of the atmosphere characterized by up-and-down currents.



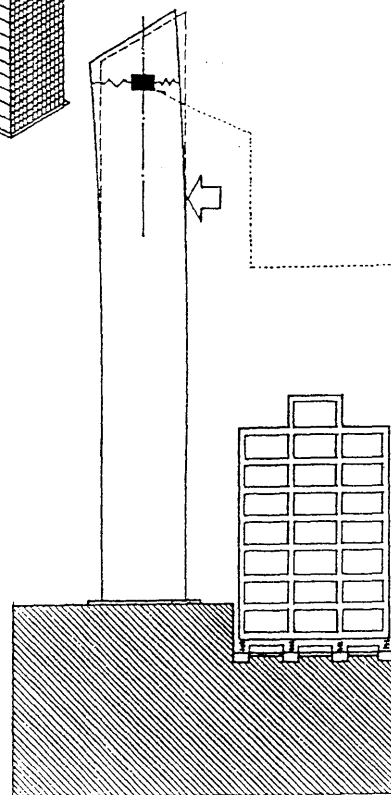
**tube structure**  
A high-rise structure having perimeter lateral force-resisting systems internally braced by rigid floor diaphragms. A tube structure acts as a cantilevered box beam in resisting lateral forces.



**damp**  
To cause a decrease in amplitude of successive oscillations or waves.

**damping mechanism**  
Any of various viscoelastic devices typically installed at structural joints to absorb the energy generated by wind or earthquake forces, progressively diminish or eliminate vibratory or oscillatory motions, and prevent destructive resonances from occurring.

**tuned mass damper**  
A heavy mass mounted on rollers and attached to the upper portion of a tall building with spring damping mechanisms, having an inertial tendency to remain at rest and thus counteracting and dissipating any building movements.



**base isolation**  
Isolating the base of a building from the ground with damping mechanisms to allow the superstructure to float as a rigid body and alter the natural period of vibration of the structure so that it is different from that of the ground, thus preventing destructive resonances from occurring.

# SURVEY

To determine the exact form, boundaries, extent, and position of a tract of land by linear and angular measurements and the application of the principles of geometry and trigonometry.

**true north**  
The direction of the north pole from a given point.

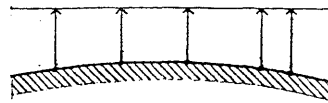
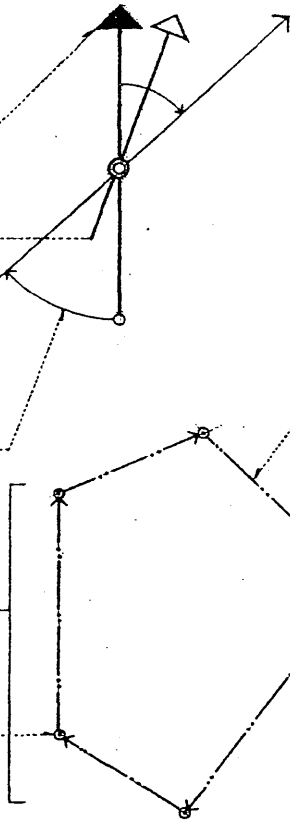
**magnetic north**  
North as indicated by the north-seeking pole of the magnetic needle in a compass.

**bearing**  
A horizontal direction expressed in degrees east or west of a true or magnetic north or south direction.

**azimuth**  
The angle of horizontal deviation, measured clockwise, of a bearing from a standard direction, as from north or south.

**traverse**  
A sequence of intersecting surveyed lines whose lengths and angles of intersection are recorded graphically on a map and as data in a table.

**place of beginning**  
The starting point for a metes-and-bounds survey.



**plane survey**  
A survey in which curvature of the earth's surface is ignored, and all distances and horizontal angles are assumed to be projected onto a horizontal plane.

**land survey**  
A survey made to establish the length and bearing of boundary lines and the area of the tract bounded by these lines.

**cadastral survey**  
A survey showing boundaries and property lines, usually made to create land units suitable for transfer of title.

**butts and bounds**  
A legal term for the boundary lines of a parcel of land as used in deeds and titles.

**plat**  
A plan or map of land in a city, town, section, or subdivision, indicating the location and boundaries of individual properties.

**survey plat**  
A legal document describing the location, boundaries, and dimensions of a tract or parcel of land, including zoning and planning commission approvals, easements and restrictions, and, for a subdivision, the dividing lines of streets, blocks, and lots, and the numbering and dimensions of each lot.

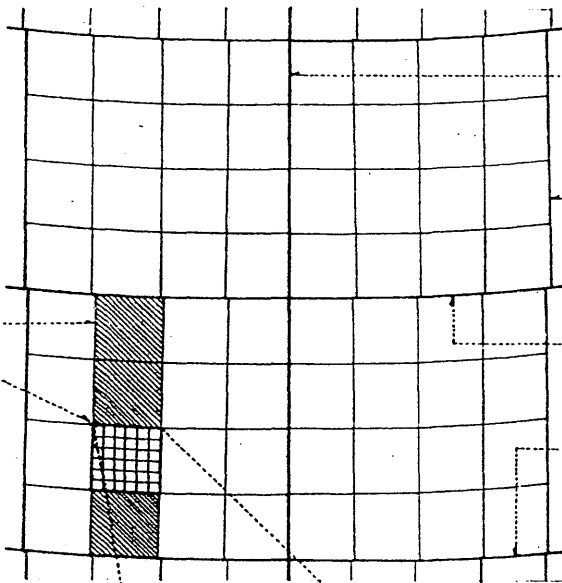
**legal description**  
A written description of the location and boundaries of a specific parcel of land, based on a metes-and-bounds survey or a rectangular system of survey, or made with reference to a recorded plat.

**metes and bounds**  
The property lines or boundaries of a parcel of line.

**metes-and-bounds survey**  
A system of land survey in which the course and length of each boundary line of a parcel of land are called out starting at a known reference point and working around the periphery of the plat until returning to the place of beginning.

**course**  
The compass direction from one reference point to the next for each leg of a metes-and-bounds survey, stated in degrees, minutes, and seconds as an angular deviation east or west of due north or south.

**rectangular system**  
A system of land survey based on a modified grid of north-south principal meridians and east-west baselines. Also called government system.



**range**  
One of a series of divisions numbered east or west from a guide meridian in the rectangular system of survey and consisting of a row of townships that are numbered north or south from a baseline.

**township**  
A unit of land area in the rectangular system of survey, approximately 36 sq. mi. (93.2 sq. km) containing 36 sections.

**section**  
One of the 36 numbered subdivisions of a township, each approximately one square mile (2.59 sq. km or 640 acres) and further subdivided into halves, quarters, and quarter quarters.

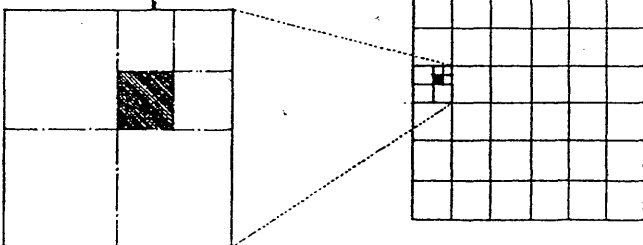
**principal meridian**  
In the rectangular system of survey, a north-south reference line established at a substantial landmark for a large area of land.

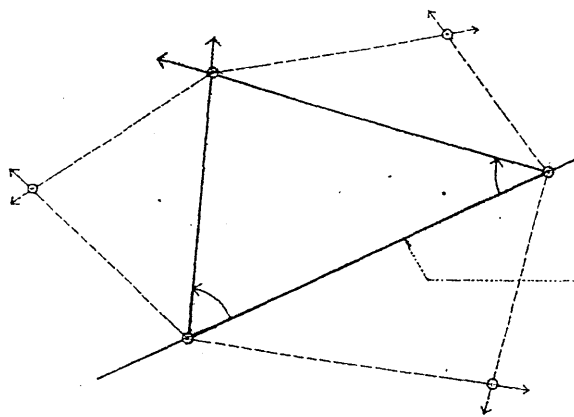
**guide meridian**  
In the rectangular system of survey, a north-south reference line located between correction lines at 24-mile intervals to the east and west of principal meridians.

**baseline**  
The principal east-west reference line for an area in the rectangular system of survey.

**correction line**  
An east-west reference line located at 24-mile intervals to the north and south of a baseline in the rectangular system of survey, established to correct for the convergence of meridians and equalize east-west distances.

**range line**  
In the rectangular system of survey, a north-south reference line located at 6-mile intervals between guide meridians.



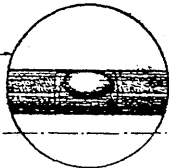


**trilateration**  
A method for determining the relative positions of three or more points by treating these points as vertices of a triangle or triangles of which the sides and angles can be measured.

**triangulation**  
A trigonometric method for determining the position of a point by taking bearings from the end points of a baseline of known or measurable length.

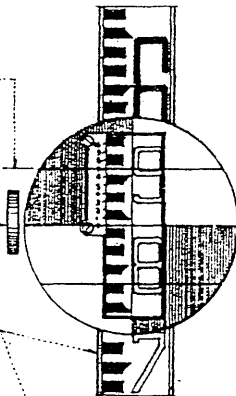
**baseline**  
A line of known length and position from which points or other lines may be established, as a corner of a building structure or a property line.

**level**  
A device for determining true horizontal or vertical directions by the centering of a bubble in a slightly bowed glass tube filled with alcohol or ether. Also called spirit level.



**artificial horizon**  
A level, as a surface of mercury.

**stadia**  
A method of surveying in which distances are read by noting the interval on a graduated rod intercepted by two horizontal cross hairs mounted in the telescope of a surveying instrument.



**target**  
A red and white disk on a leveling rod that facilitates the sighting and reading of the rod.

**rod**  
A straight pole or bar, conspicuously marked with graduations, and used in measuring the vertical distance between a point on the ground and the line of sight of a surveyor's level. Also called leveling rod, stadia rod.

**chain**  
A distance-measuring device consisting of 100 metal links of equal length.

**Gunter's chain**  
A distance-measuring device consisting of 100 metal links and a total length of 66 ft. (20 m). Also called surveyor's chain.

**engineer's chain**  
A distance-measuring device consisting of 100 metal links and a total length of 100 ft. (30 m).

**transit**  
A surveying instrument, as a theodolite, having a telescope that can be reversed by turning in a vertical plane, used for measuring horizontal and sometimes vertical angles.

**theodolite**  
A precision instrument having a telescopic sight for establishing horizontal and sometimes vertical angles.

**alidade**  
The entire upper part of a transit or theodolite, including the telescope, its supports, spirit level, horizontal circle, leveling devices, and the spindle.

**horizontal circle**  
A circular plate, graduated in degrees, minutes, and seconds, and fixed to the base of a transit for measuring horizontal angles.

**optical plummet**  
A device for centering a transit or theodolite over a reference point, used in place of a plumb bob in a strong wind.

**leveling**  
A procedure for determining the difference in elevation between two points by means of a level or transit and a rod. Also called differential leveling.

**elevation**  
The vertical distance above or below a datum.

**spot elevation**  
The elevation of a certain point relative to a specified datum.

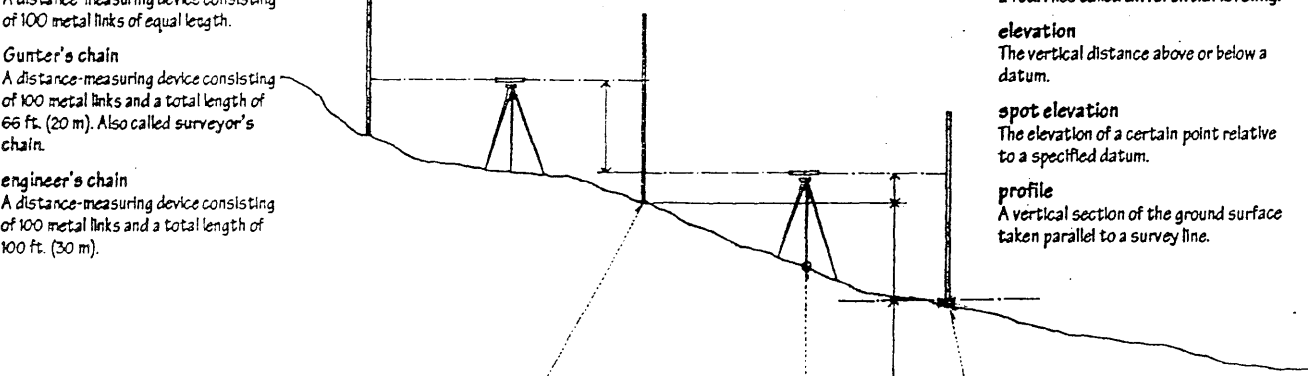
**profile**  
A vertical section of the ground surface taken parallel to a survey line.

**datum**  
Any level surface, line, or point used as a reference from which elevations are measured.

**turning point**  
A point temporarily located and marked in order to establish the elevation or position of a surveying instrument at a new station.

**station**  
A precisely located reference point over which a surveying instrument is centered. Also called instrument station, set-up.

**bench mark**  
A marked point of known or assumed elevation, usually on a permanent object, from which other elevations may be established.



## TEMPLE

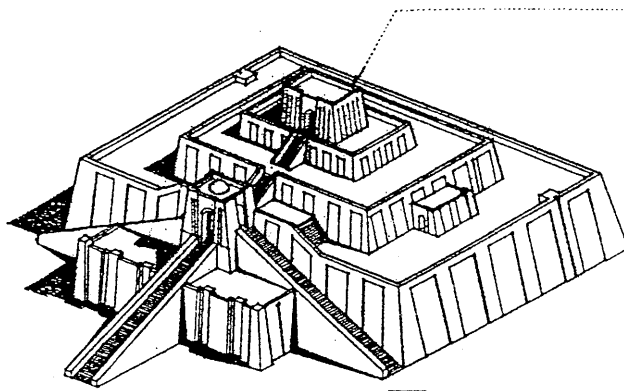
An edifice or place dedicated to the worship or presence of a deity.

### sacred

Of or pertaining to religious objects, rites, or practices, as opposed to the secular or profane.

### secular

Of or pertaining to the temporal or worldly rather than the sacred or spiritual. Also, profane.



### ziggurat

A temple-tower in Sumerian and Assyrian architecture, built in diminishing stages of mud brick with buttressed walls faced with burnt brick, culminating in a summit shrine or temple reached by a series of ramps; thought to be of Sumerian origin, dating from the end of the 3rd millennium B.C. Also, zikkurat.

### Tower of Babel

A temple-tower presumed to be the great ziggurat at Babylon, which no longer survives, though it was seen and described by the Greek historian, Herodotus, in the 5th century B.C.:

*"And they said to one another, Let us make brick, and burn it thoroughly. And they had brick for stone, and slime for mortar. And they said, Let us build a city and a tower, whose top may reach unto heaven; and let us make a name, lest we be scattered abroad upon the face of the whole earth."*  
—Genesis 11:4

### Lamassu

The monumental stone sculptures of human-headed, winged bulls or lions that guarded the entrances to Mesopotamian palaces and temples.



### menhir

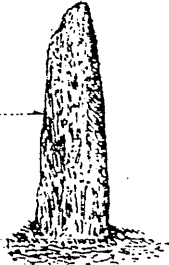
A prehistoric monument consisting of an upright megalith, usually standing alone but sometimes aligned with others.

### megalith

A very large stone used as found or roughly dressed, esp. in ancient construction work.

### monolith

A single block of stone of considerable size, often in the form of an obelisk or column.

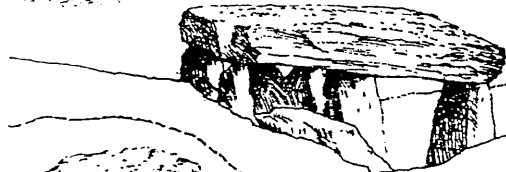


### cairn

A heap of stones piled up as a monument, tombstone, or landmark. Also, cairn.

### passage grave

A megalithic tomb of the Neolithic and early Bronze Ages found in the British Isles and Europe, consisting of a roofed burial chamber and narrow entrance passage, covered by a tumulus; believed to have been used for successive family or clan burials spanning a number of generations. Also called chamber grave.



### tumulus

An artificial mound of earth or stone, esp. over an ancient grave. Also called barrow.

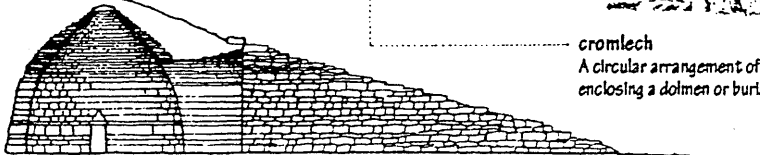


### dolmen

A prehistoric monument consisting of two or more large upright stones supporting a horizontal stone slab, found esp. in Britain and France and usually regarded as a tomb.

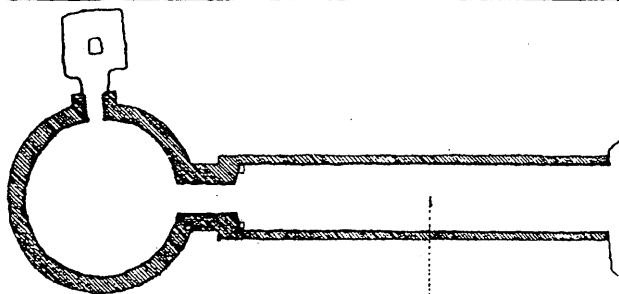
### trilithon

Two upright megaliths supporting a horizontal stone. Also called trilith.



### cromlech

A circular arrangement of megaliths enclosing a dolmen or burial mound.



### shaft grave

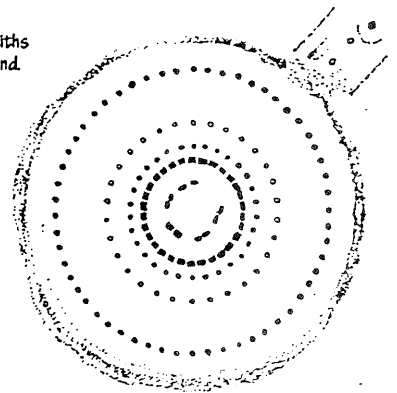
A tomb of the Aegean civilizations consisting of a deep rectangular cut into sloping rock and a roof of timber or stone.

### beehive tomb

A stone-built subterranean tomb of the Mycenaean civilization consisting of a circular chamber covered by a corbeled dome and entered by a walled passage through a hillside. Also called tholos.

### dromos

A long, deep passageway into an ancient subterranean tomb.



### Stonehenge

A megalithic monument erected in the early Bronze Age c.2700 B.C. on Salisbury Plain, Wiltshire, England, consisting of four concentric rings of trilithons and menhirs centered around an altar stone; believed to have been used by a sun cult or for astronomical observations.

**mastaba**

An ancient Egyptian tomb made of mud brick, rectangular in plan with a flat roof and sloping sides, from which a shaft leads to underground burial and offering chambers.

**serdab**

A small chamber inside a mastaba containing a statue of the deceased.

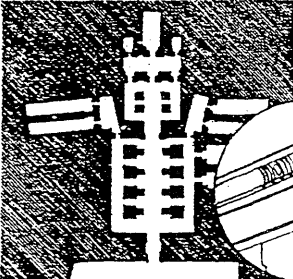
**uraeus**

The figure of the sacred asp, depicted on the headdress of ancient Egyptian rulers and deities as an emblem of supreme power.



**pharaoh**

Any of the rulers of ancient Egypt who were believed to be divine and had absolute power.



**rock-cut tomb**

A tomb hewn out of native rock, presenting only an architectural front with dark interior chambers, of which the sections are supported by masses of stone left in the form of solid pillars.

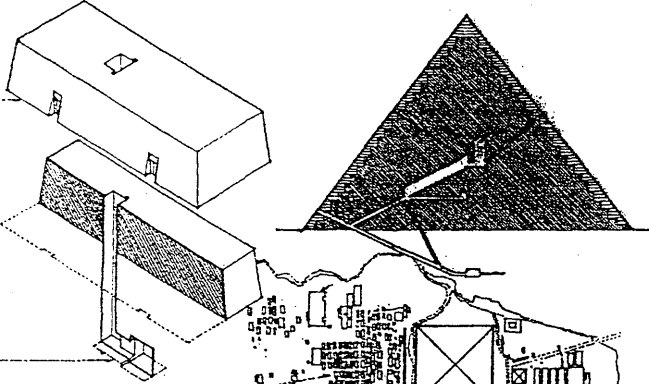
**obelisk**

A tall, four-sided shaft of stone that tapers as it rises to a pyramidal point, originating in ancient Egypt as a sacred symbol of the sun-god Ra and usually standing in pairs astride temple entrances.



**Osirian column**

An ancient Egyptian column incorporating the sculptured figure of Osiris, the Egyptian god of death and resurrection.



**pyramid**

A massive masonry structure having a rectangular base and four smooth, steeply sloping sides facing the cardinal points and meeting at an apex, used in ancient Egypt as a tomb to contain the burial chamber and the mummy of the pharaoh. The pyramid was usually part of a complex of buildings within a walled enclosure, including mastabas for members of the royal family, an offering chapel and a mortuary temple. A raised causeway led from the enclosure down to a valley temple on the Nile, where purification rites and mummification were performed.

**necropolis**

A historic burial ground, esp. a large, elaborate one of an ancient city.

**cavetto**

A concave molding having an outline that approximates a quarter circle.

**cavetto cornice**

A characteristic cornice of Egyptian buildings, consisting of a large cavetto decorated with vertical leaves and a roll molding below. Also called Egyptian gorge.

**sphinx**

A figure of an imaginary creature having the body of a lion and the head of a man, ram, or hawk, commonly placed along avenues leading to ancient Egyptian temples or tombs.

**syrinx**

A narrow rock-cut corridor in an ancient Egyptian tomb.

**causeway**

A raised passageway ceremonially connecting the valley temple with an ancient Egyptian pyramid.

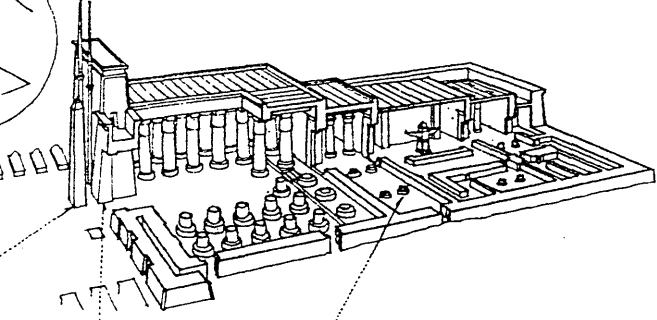


**cult temple**

An ancient Egyptian temple for the worship of a deity, as distinguished from a mortuary temple.

**mortuary temple**

An ancient Egyptian temple for offerings and worship of a deceased person, usually a deified king. In the New Kingdom, cult and funerary temples had many features in common: an avenue of sphinxes leading to a tall portal guarded by a towering pylon, an axial plan with a colonnaded forecourt and a hypostyle hall set before a dark, narrow sanctuary in which stood a statue of the deity, and walls lavishly decorated with pictographic carvings in low or sunken relief. Many of the major temples grew by accretion due to the pious ambitions of successive pharaohs, who believed in the afterlife and were determined to create an enduring reputation through their buildings.



**pylon**

A monumental gateway to an ancient Egyptian temple, consisting either of a pair of tall truncated pyramids and a doorway between them or of one such masonry mass pierced with a doorway, often decorated with painted reliefs.

**hypostyle hall**

A large hall having many columns in rows supporting a flat roof, and sometimes a clerestory; prevalent in ancient Egyptian and Achaemenid architecture.

**propylon**

A freestanding gateway having the form of a pylon and preceding the main gateway to an ancient Egyptian temple or sacred enclosure.

**Hathor-headed**

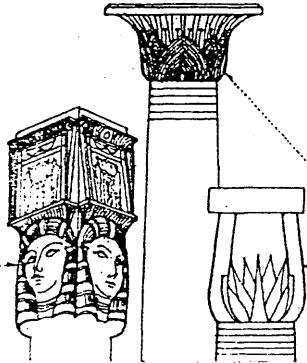
Noting an ancient Egyptian column having as its capital the head of Hathor, the Egyptian goddess of love and happiness, often represented with the head or horns of a cow. Also, Hathoric.

**palm capital**

An ancient Egyptian capital shaped like the crown of a palm tree.

**lotus capital**

An ancient Egyptian capital having the shape of a lotus bud.



# TEMPLE

## megaron

A building or semi-independent unit of a building, typically having a rectangular principal chamber with a center hearth and a porch, often of columns in antis; traditional in Greece since Mycenaean times and believed to be the ancestor of the Doric temple.

## Greek temple

A temple built as a shrine to the ancient Greek god or goddess to whom it was dedicated. Since the temple was not intended for internal worship, it was built with special regard for external effect. It stood on a stylobate of three or more steps, with a cella containing the statue of the deity and front and rear porticoes, the whole being surmounted by a low gable roof of timber, covered in terracotta or marble tiles.

## altar

An elevated place or structure upon which sacrifices are offered or incense burned in worship, or before which religious rites are performed.

## cella

The principal chamber or enclosed part of a classical temple, where the cult image was kept. Also called naos.

## pediment

A wide, low-pitched gable surmounting a colonnade or a major division of a facade.

## tympanum

The triangular space enclosed by the horizontal and raking cornices of a pediment, often recessed and decorated with sculpture.

## stylobate

A course of masonry forming the foundation for a row of columns, esp. the outermost colonnade of a classical temple.

## stereobate

A solid mass of masonry visible above ground level and serving as the foundation of a building, esp. the platform forming the floor and substructure of a classical temple. Also called crepidoma, podium.

## tabernacle

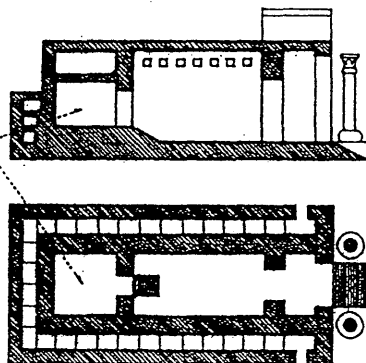
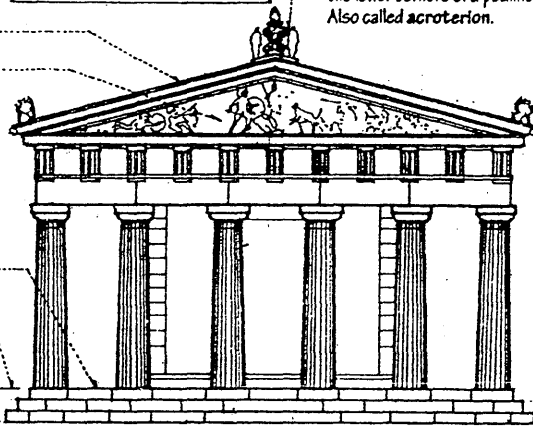
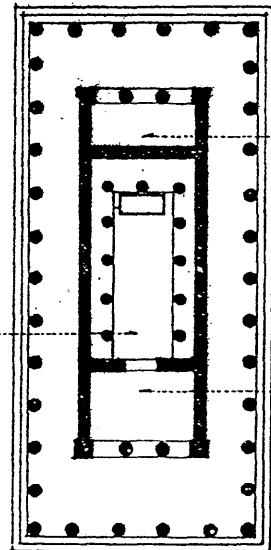
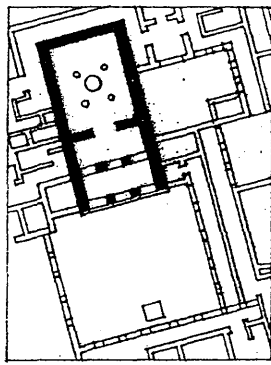
The portable sanctuary in which the Hebrews carried the ark of the covenant through the desert until the building of the Temple of Jerusalem by Solomon.

## holy of holies

The innermost chamber in the biblical Tabernacle and the Temple in Jerusalem where the ark of the covenant was kept. Also called sanctum sanctorum.

## Ark of the Covenant

The chest containing two stone tablets inscribed with the Ten Commandments, carried by the Hebrews during their desert wanderings after the Exodus.



**epinaos**  
The rear vestibule of a classical temple. Also called opisthodomos, posticum.

**pronaos**  
An open vestibule before the cella of a classical temple. Also called anticum.

**acroterium**  
A pedestal for a sculpture or ornament at the apex or at each of the lower corners of a pediment. Also called acroterion.

## agora

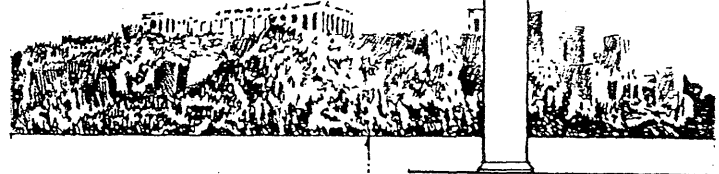
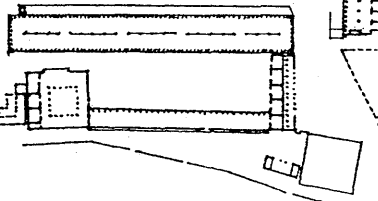
A marketplace or public square in an ancient Greek city, usually surrounded with public buildings and porticoes and commonly used as a place for popular or political assembly.

## stoa

An ancient Greek portico, usually detached and of considerable length, used as a promenade or meeting place around public places.

## temenos

In ancient Greece, a piece of ground specially reserved and enclosed as a sacred place.



**stela**  
An upright stone slab or pillar with a carved or inscribed surface, used as a monument or marker, or as a commemorative tablet in the face of a building. Also, stela.

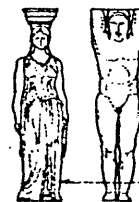
## acropolis

The fortified high area or citadel of an ancient Greek city.



## antefix

An upright ornament at the eaves of a tile roof concealing the foot of a row of convex tiles that cover the joints of the flat tiles.



## atlas

A sculptured figure of a man used as a column. Also called telamon.

## caryatid

A sculptured female figure used as a column. Also called canephora.

## Temple of Solomon

The first Temple of Jerusalem, completed c950 B.C. by Phoenician artisans under the direction of King Solomon and destroyed by Nebuchadnezzar II in 586 B.C. Based on Canaanite and Phoenician prototypes, it was oblong in shape, and consisted of three main parts: an outer hall (ulam), the main sanctuary (hekhal), and the holy of holies (debir), all decorated with massive carvings in ivory, gold, and cedar.

## synagogue

A building or place of assembly for Jewish worship and religious instruction.

## bimah

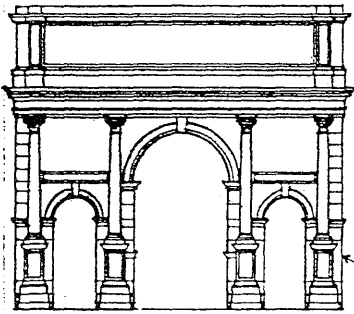
The platform in a synagogue from which services are conducted. Also called almamar, bema.

## Holy Ark

The cabinet in a synagogue in which the scrolls of the Torah are kept, set into or against the wall that faces toward Jerusalem.

**basilica**  
A large oblong building used as a hall of justice and public meeting place in ancient Rome, typically having a high central space lit by a clerestory and covered by timber trusses, and a raised dais in a semicircular apse for the tribunal. The Roman basilica served as a model for early Christian basilicas.

**tribunal**  
A raised platform in an ancient Roman basilica for the seats of magistrates. Also, tribune.



**triumphal arch**  
A monumental memorial arch erected astride the line of march of a victorious army during its triumphal procession.

**arch order**  
The engaged columns and entablature framing an arch, as in a triumphal arch.

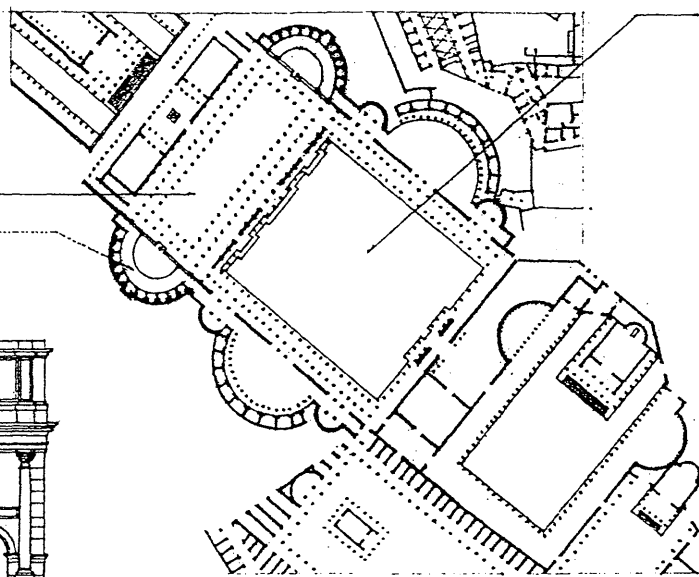
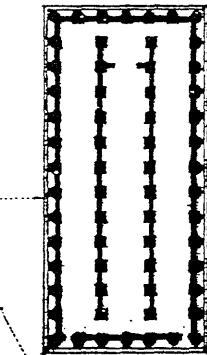
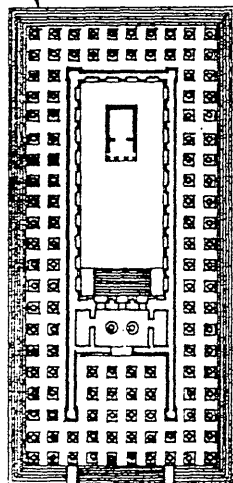
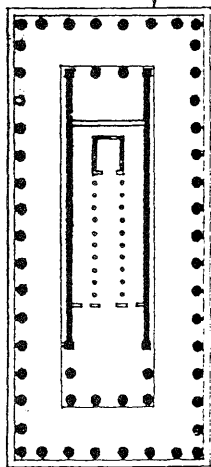
**clithral**  
Of or pertaining to a classical temple that is roofed over.

**hypethral**  
Of or pertaining to a classical temple that is wholly or partly open to the sky. Also, hypaethral.

**pseudoperipteral**  
Having engaged columns at the sides.

**dipteral**  
Having two rows of columns on all sides.

**pseudodipteral**  
Having an arrangement of columns suggesting a dipteral structure but without the inner colonnade.



**forum**  
The public square or marketplace of an ancient Roman city, the center of judicial and business affairs, and a place of assembly for the people, usually including a basilica and a temple.

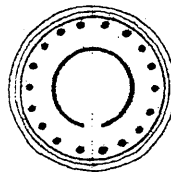
**pantheon**  
A temple dedicated to all the gods of a people.

**cenotaph**  
A monument erected in memory of a deceased person whose remains are buried elsewhere.

**cyrtostyle**  
A convex, usually semicircular portico.

**cyclostyle**  
A circular colonnade or peristyle open at the center.

**monopteron**  
A circular building having a single row of columns surrounding a central structure or a courtyard. Also, monopteros.



**distyle in antis**  
Having two columns in front between antae.

**antae**  
A rectangular pier or pilaster formed by thickening the end of a projecting wall.

**prostyle**  
Having a portico on the front only.

**apteral**  
Without a colonnade along the sides.

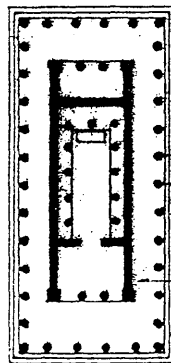
**amphiprostyle**  
Prostyle on both fronts.



**peripteral**  
Having a single row of columns on all sides.

**pteron**  
A colonnade parallel to, but apart from the cella.

**pterooma**  
The passage between the pteron and the cella.



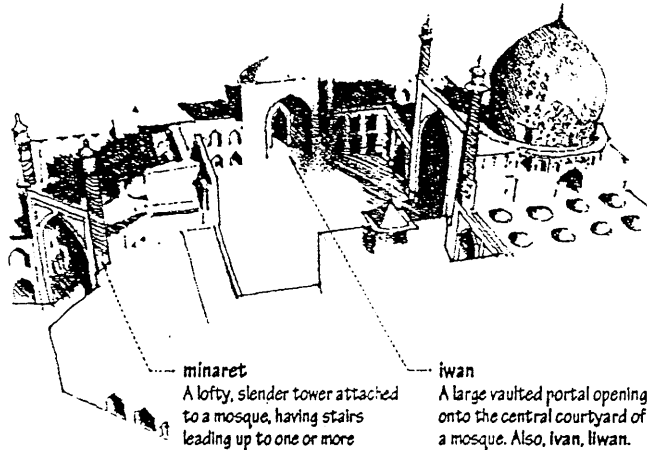
# TEMPLE

**mosque**  
A Muslim building or place of public worship. Also called *masjid*, *musjid*.

**madrasah**  
A Muslim theological school arranged around a courtyard and attached to a mosque, found from the 11th century on in Egypt, Anatolia, and Persia. Also, *madrasa*.

**maidaan**  
The large open square of a city, used as a marketplace or parade ground, esp. in India. Also, *meidan*, *meidan*.

**ziyada**  
A court or series of courts serving to shelter a mosque from immediate contact with secular buildings.



**minaret**  
A lofty, slender tower attached to a mosque, having stairs leading up to one or more projecting balconies from which the muezzin calls the Muslim people to prayer.

**iwān**  
A large vaulted portal opening onto the central courtyard of a mosque. Also, *ivan*, *liwan*.

**Islam**  
The religious faith of Muslims, based on the teachings of the prophet Muhammad, the central themes of which are belief in the one God, Allah, the existence of Paradise and Hell, and the universal Judgment Day to come. Also called *Muhammadanism*.

**Muslim**  
Of or pertaining to the law, religion, or civilization of Islam; a believer in Islam. Also, *Mostem*, *Muslem*.

**Muhammad**  
Arab prophet and founder of Islam, A.D. 570–632. Also, *Mohammed*.

**Koran**  
The sacred text of Islam, revered as the revelations made by Allah to Muhammad through the angel Gabriel and accepted as the foundation of Islamic law, religion, culture, and politics.

**mimbar**  
A pulpit in a mosque, recalling the three steps from which Muhammad addressed his followers.

**qibla**  
The wall in a mosque in which the mihrab is set, oriented to Mecca. Also, *qiblah*, *kibla*, *hblah*.

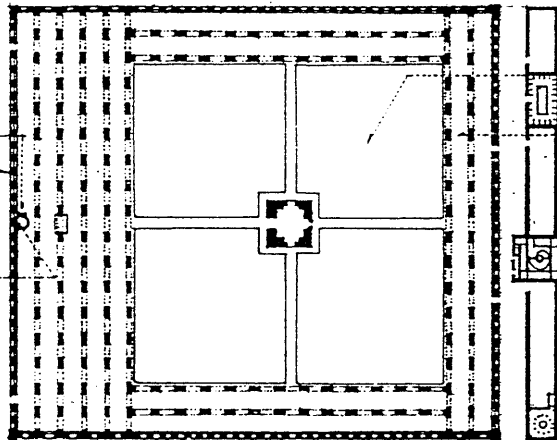
**mihrab**  
A niche or decorative panel in a mosque designating the qibla.

**Mecca**  
A city in Saudi Arabia, birthplace of Muhammad and spiritual center of Islam.

**Ka'ba**  
A small, cubical stone building in the courtyard of the Great Mosque at Mecca containing a sacred black stone and regarded by Muslims as the House of God, the objective of their pilgrimages, and the point toward which they turn in praying. Also, *Ka'aba*, *Ka'abah*.

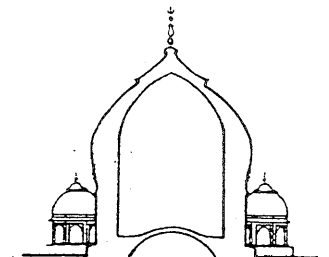
**caravansary**  
An inn in the Near East for the overnight accommodation of caravans, usually having a large courtyard enclosed by a solid wall and entered through an imposing gateway. Also, *caravanserai*.

**pyramid**  
A masonry mass having a rectangular base and four stepped and sloping faces culminating in a single apex, used in ancient Egypt and pre-Columbian Central America as a tomb or a platform for a temple.

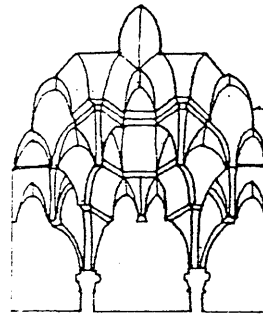
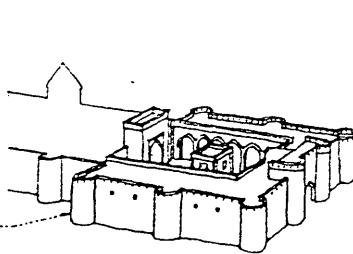


**sahn**  
The central courtyard of a mosque.

**riwaq**  
An arcaded hall of a mosque.



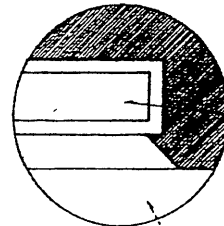
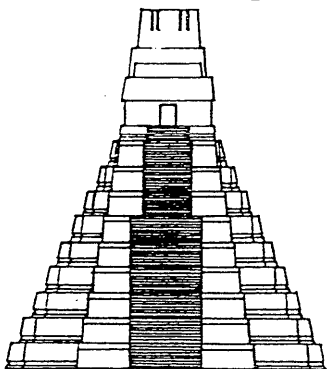
**melon dome**  
A bulbous ribbed dome, found esp. in Islamic architecture.



**stalactite work**  
A system of decoration in Islamic architecture, formed by the intricate corbeling of brackets, squinches, and inverted pyramids; sometimes wrought in stone but more often in plaster. Also called *honeycomb work*, *muqarna*.

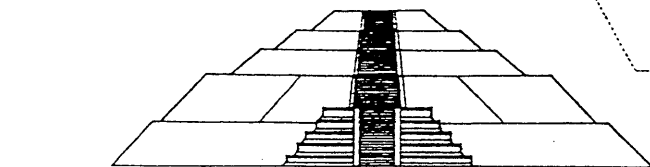
**pendentive bracketing**  
Corbeling having the general form of a pendentive, commonly found in Moorish architecture.

**maksoorah**  
An openwork screen or partition enclosing an area for prayer or a tomb in a mosque.



**tablero**  
A rectangular, strongly framed panel that overhangs a talud. An original contribution of Teotihuacán architecture, this tablero-talud combination was introduced c.A.D. 150 to differentiate the stages of stepped pyramids and altar platforms. It is widely copied throughout Mesoamerica, with regional variations.

**talud**  
In Mesoamerican architecture, an outer wall that slopes inward as it rises. The talud first appeared c.800 B.C. at the Olmec site of La Venta, in Tabasco state, Mexico.





**Hinduism**

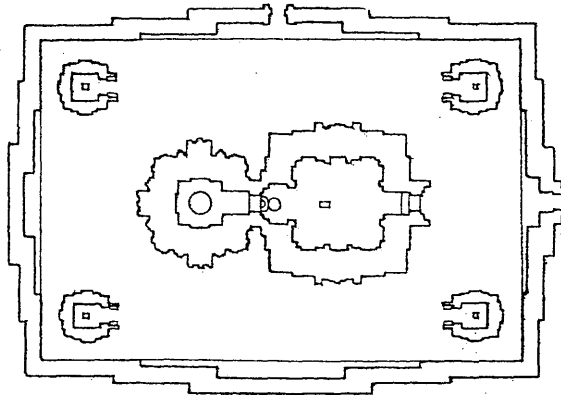
The dominant religion of India, based upon the religion of the original Aryan settlers as expounded and evolved in the Vedas, having a diverse body of philosophy and cultural practices, many popular cults, and a large pantheon symbolizing a supreme being of many forms and natures. Buddhism is outside the Hindu tradition but is regarded as a related religion.

**pantheon**

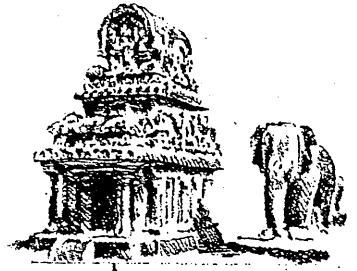
The officially recognized gods of a people.

**Vedas**

The oldest sacred writings of Hinduism, composed between 1500 and 800 B.C., incorporating four collections hymns, prayers, and liturgical formulas: Rig-Veda, Yajur-Veda, Sama-Veda, and Atharva-Veda.



**mandira**  
A Hindu temple.



**rath**  
A Hindu temple cut out of solid rock to resemble a chariot. Also, ratha.

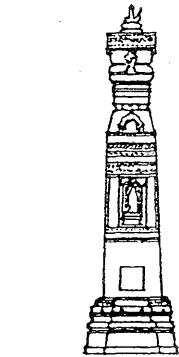
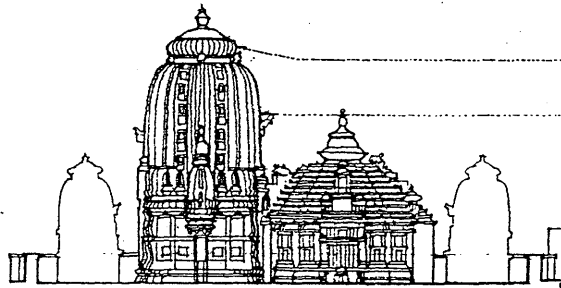
**vimana**  
The sanctuary of a Hindu temple in which a deity is enshrined.

**amalaka**  
The bulbous stone finial of a shikhara.

**shikhara**  
A tower of a Hindu temple, usually tapered convexly and capped by an amalaka. Also, sikra.

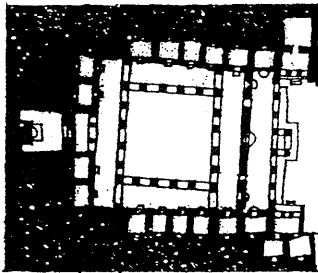
**mandapa**  
A large, porchlike hall leading to a Hindu temple and used for religious dancing and music.

**gopuram**  
A monumental, usually ornate gateway tower to a Hindu temple enclosure, esp. in southern India. Also, gopura.



**stamba**  
A freestanding memorial pillar in Indian architecture, bearing carved inscriptions, religious emblems, or a statue. Also, stambha.

**lit**  
A monolithic stamba, as distinguished from one built up of stone courses.



**vihara**  
A Buddhist monastery in Indian architecture often excavated from solid rock, consisting of a central pillared chamber surrounded by a verandah onto which open small sleeping cells. Adjacent to this cloister was a courtyard containing the main stupa.

**chaitya**  
A Buddhist shrine in India, usually carved out of solid rock on a hillside, having the form of an aisled basilica with a stupa at one end.

**wat**  
A Buddhist monastery or temple in Thailand or Cambodia.

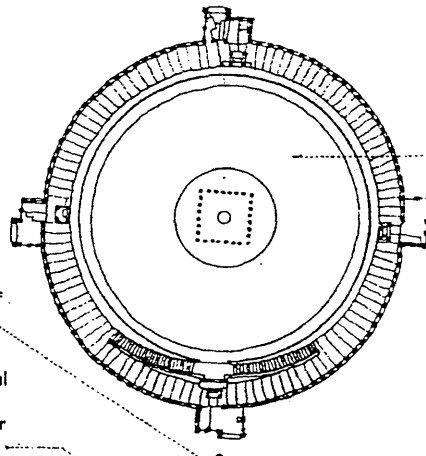
**Khmer**  
A people of Cambodia who established an empire in the 5th century A.D. and dominated most of Indochina from the 9th to the 12th centuries.

**tee**  
A finial in the form of a conventionalized umbrella, used on stupas, topes, and pagodas.

**chattri**  
An umbrella-shaped finial symbolizing dignity, composed of a stone disk on a vertical pole.

**torana**  
An elaborately carved, ceremonial gateway in Indian Buddhist and Hindu architecture, having two or three lintels between two posts.

**vedika**  
A railing enclosing a sacred area, as a stupa.

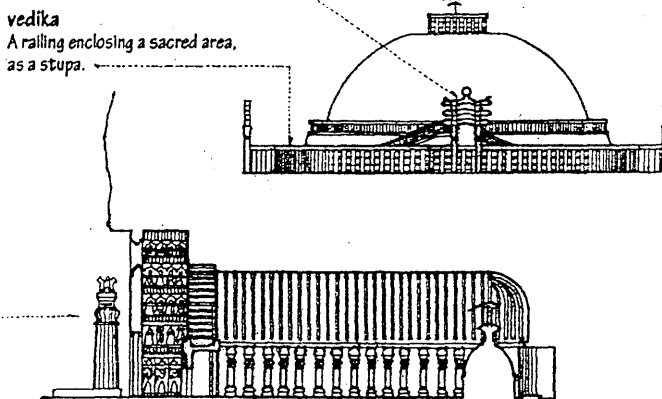


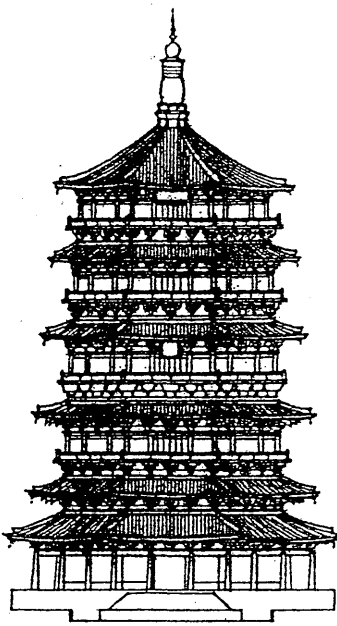
**stupa**  
A Buddhist memorial mound erected to enshrine a relic of Buddha and to commemorate some event or mark a sacred spot. Modeled on a funerary tumulus, it consists of an artificial dome-shaped mound raised on a platform, surrounded by an outer ambulatory with a stone vedika and four toranas, and crowned by a chattri. The name for the stupa in Ceylon is dagoba, and in Tibet and Nepal, chorten. Also called tope.

**Buddhism**  
A religion based on the Four Noble Truths, originated in India by Gautama Buddha and later spreading to China, Burma, Japan, Tibet, and parts of Southeast Asia.

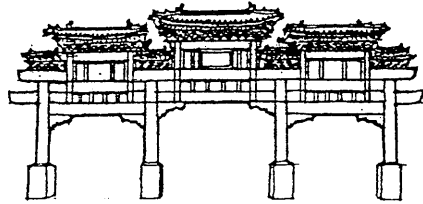
**Four Noble Truths**  
The doctrines of Buddha: all life is suffering; the cause of suffering is desire; cessation of suffering is possible through Nirvana – the extinction of craving; Nirvana can be reached through mental and moral self-purification.

**Buddha**  
Title of Gautama Siddhartha c563–c483 B.C., Indian philosopher, religious leader, and founder of Buddhism. Also called Gautama Buddha.





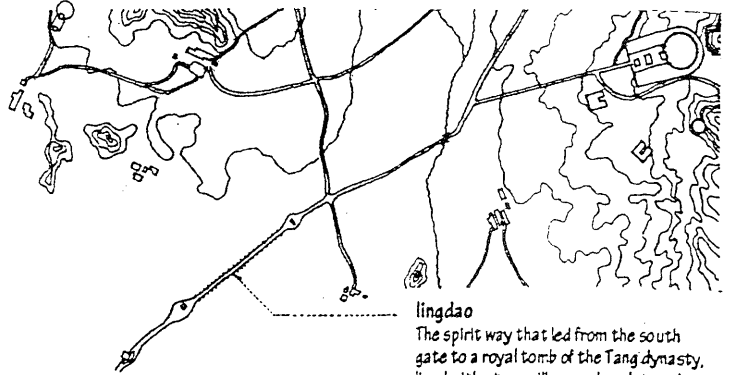
**pagoda**  
A Buddhist temple in the form of a square or polygonal tower with roofs projecting from each of its many stories, erected as a memorial or to hold relics. From the stupa, the Indian prototype, the pagoda gradually changed in form to resemble the traditional multistoried watch tower as it spread with Buddhism to China and Japan. Pagodas were initially of timber, but from the 6th century on, were more frequently of brick or stone, possibly due to Indian influence.



**pailou**  
A monumental gateway in Chinese architecture, having a trabeated form of stone or wood construction with one, three, or five openings and often bold projecting roofs, erected as a memorial at the entrance to a palace, tomb, or sacred place; related to the Indian toranas and the Japanese torii. Also, pailoo.

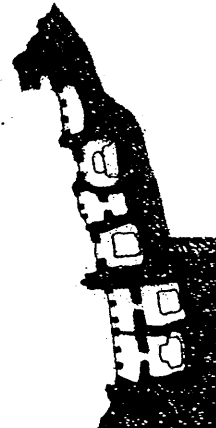
**zhonglou**  
A bell tower or pavilion in Chinese architecture, located at the right side of a city gate, palace entrance, or forecourt of a temple.

**gulou**  
A large drum tower or pavilion in Chinese architecture, located at the left side of a city gate, palace entrance, or forecourt of a temple.



**lingdao**  
The spirit way that led from the south gate to a royal tomb of the Tang dynasty, lined with stone pillars and sculptured animal and human figures.

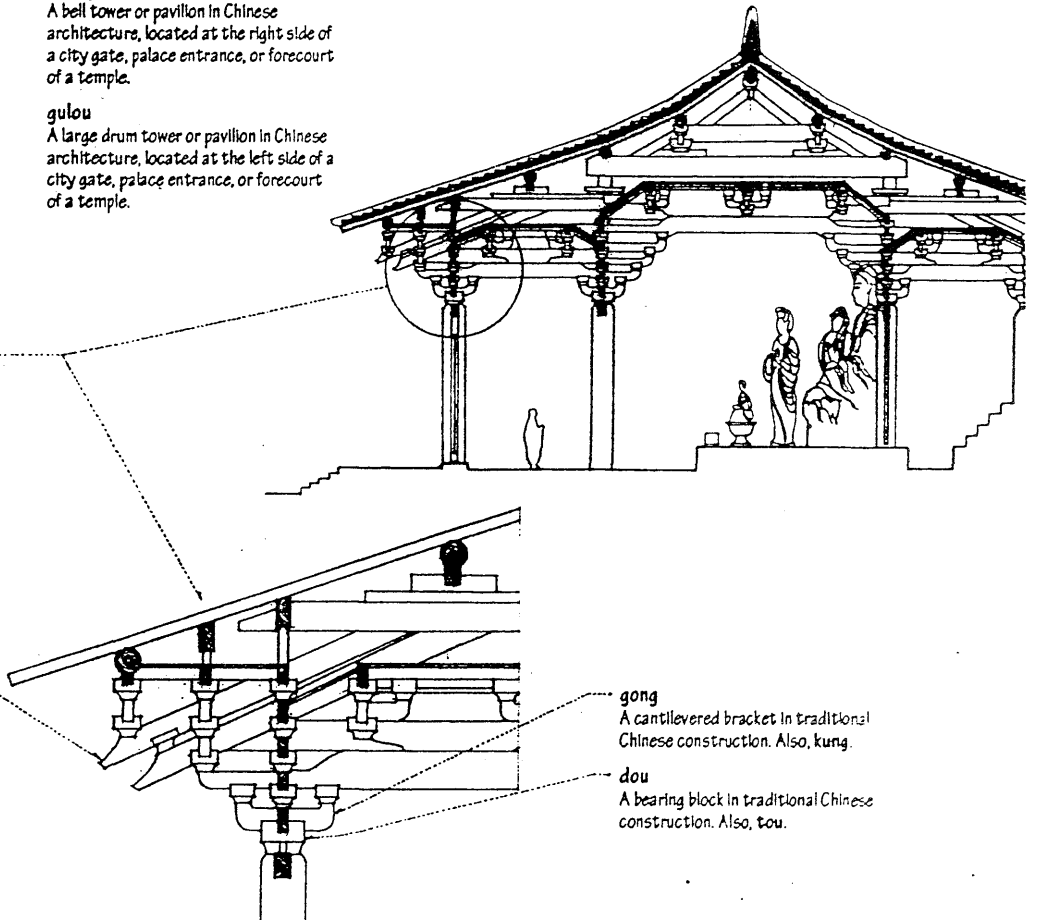
**Tang**  
A dynasty in China, A.D. 618–907, marked by territorial expansion, the invention of printing, prosperous trade, and the development of poetry. Also, Tang.



**Yungang**  
A large Buddhist monastic center in northwest China, begun in A.D. 460, where there are numerous cave temples, each having a shallow, oval-shaped interior with a massive central image of Buddha flanked by two smaller Buddhas; the concept of carving into cliffs is believed to have come to China from India. Also, Yün-kang.

**dougong**  
A bracket system used in traditional Chinese construction to support roof beams, project the eaves outward, and support the interior ceiling. The absence of a triangular tied frame in Chinese architecture made it necessary to multiply the number of supports under the rafters. In order to reduce the number of pillars this would normally require, the area of support afforded by each pillar was increased by the dougong. Also, tou-kung.

**ang**  
A lever arm in traditional Chinese construction, placed parallel to the rafters and raked at an angle to counterbalance the forces applied by the inner and outer purlins. The ang supports the outermost purlin by means of a bracket or cross-beam and is pinned at the inner end against a purlin.



**gong**  
A cantilevered bracket in traditional Chinese construction. Also, kung.

**dou**  
A bearing block in traditional Chinese construction. Also, tou.

**katsuogi**  
The short wooden billets placed at right angles to the ridge of a Shinto shrine.

**chigi**  
The crossed finial formed by the projecting barge boards at each end of the ridge of a Shinto shrine.

**hashira**  
A sacred post in Shinto architecture, shaped by human hands.

**Nagare-zukuri**  
A style of Shinto shrine, based on the Ise prototype, but with the front slope of the roof extending to form a canopy over the entrance stair; this space eventually developed into a prayer room for worshippers.

**Kasuga-zukuri**  
A style of Shinto shrine, characterized by a hipped roof extending from the main roof, over a centrally placed entrance stair at one gable end.

**haiden**  
The hall of worship of a Shinto shrine, usually in front of the honden.

**honden**  
The main sanctuary of a Shinto shrine.

**bent approach**  
An approach through two gateways that are not aligned, so that it is necessary to make a sharp turn to pass from the first through the second, used for privacy in houses or temples, or for security in fortifications.

**torii**  
A monumental, freestanding gateway on the approach to a Shinto shrine, consisting of two pillars connected at the top by a horizontal crosspiece and a lintel above it, usually curving upward.

**Shinto**  
The indigenous religion of Japan, marked by a cultic devotion to deities of natural forces, ancestor worship, and veneration of the emperor as a descendant of the Sun-Goddess, Amaterasu.

**Shimmei-zukuri**  
A style of Shinto shrine embodying the original style of Japanese building, before the introduction of Buddhism. It consists essentially of a small unpainted rectangular structure raised above ground level on posts inserted directly into the earth. A railed veranda surrounds the structure at floor level, a freestanding post at each gable end supports the ridge, and the bargeboards extend outward from the thickly thatched roof, forming chigi at each end.

**kodo**  
An assembly hall for monks in a Japanese Buddhist temple, in which sacred texts are read.

**to**  
A Japanese pagoda enshrining Buddhist holy relics.

**sorin**  
The crowning spire on a Japanese pagoda.

**kondo**  
Golden Hall: the sanctuary where the main image of worship is kept in a Japanese Buddhist temple. The Jodo, Shinshu, and Nichiren sects of Buddhism use the term hondo for this sanctuary, the Shingon and Tendai sects use chudo, and the Zen sect uses butsuden.

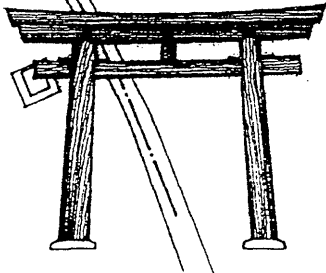
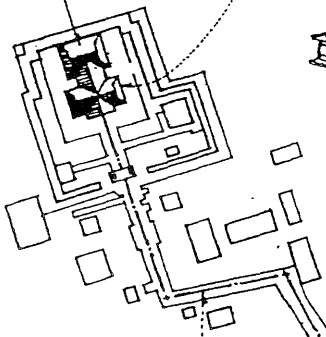
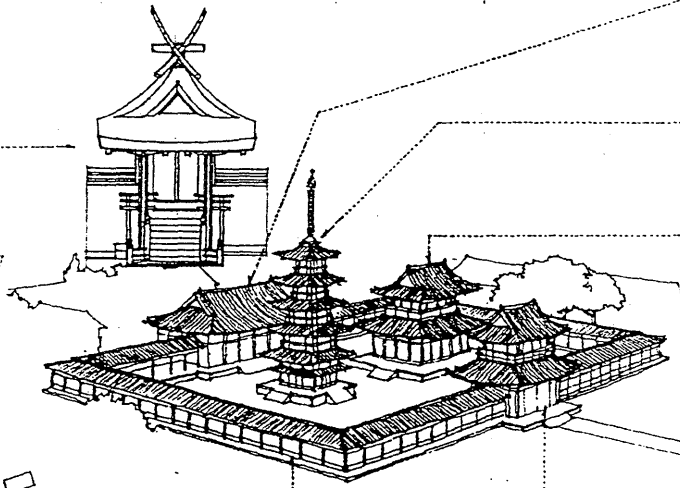
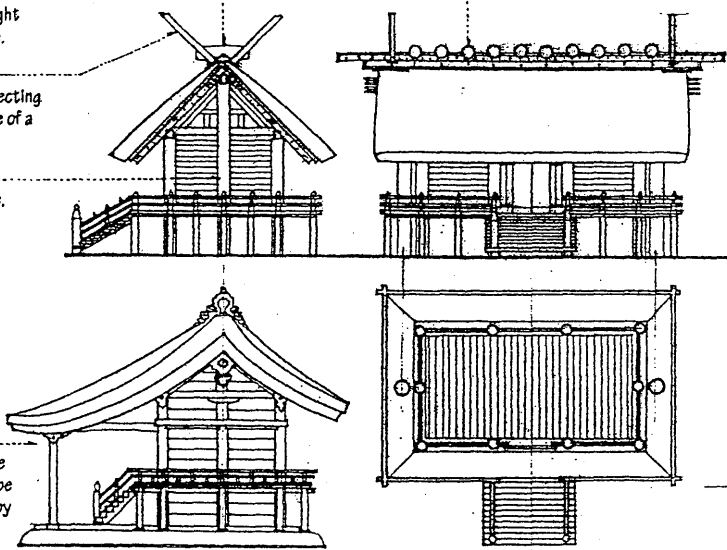
**nandaimon**  
The principal south gateway to a Japanese temple or shrine.

**chumon**  
The inner gateway to the precinct of a Japanese Buddhist temple.

**shoro**  
A structure from which the temple bell is hung, as one of a pair of small, identical, symmetrically placed pavilions in a Japanese Buddhist temple.

**butsu**  
A representation of Buddha.

**daibutsu**  
A large representation of Buddha.



# THEATER

A building, part of a building, or an outdoor area for housing dramatic presentations, stage entertainment, or motion-picture shows.

## Greek theater

An open-air theater, usually hollowed out of the slope of a hillside with a tiered seating area around and facing a circular orchestra backed by the skene, a building for the actors' use.

### orchestra

The circular space in front of the stage in the ancient Greek theater, reserved for the chorus.

### chorus

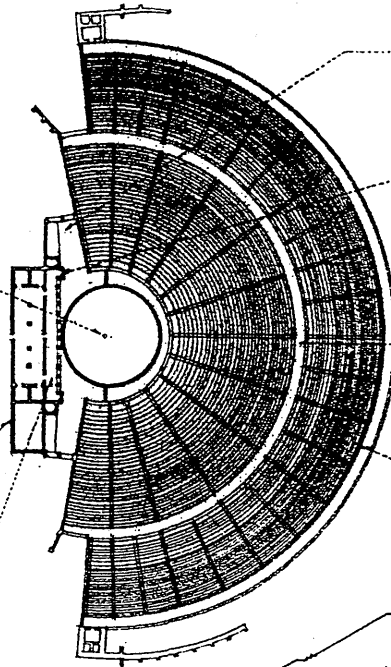
The group of actors in ancient Greece that served as major participants in or commentators on the main action of the drama.

### skene

A structure facing the audience in an ancient Greek theater, forming the background before which performances were given.

### proscenium

The front part of the stage of an ancient Greek or Roman theater upon which the actors performed.



### parodos

One of the two side passageways to an ancient Greek theater, between the stage and the seating area, through which the chorus entered the orchestra.

### parascenium

Either of two wings flanking and projecting forward from the skene of an ancient Greek theater, containing apartments for the actors.

### diazoma

An aisle between the lower and upper tiers of seats in an ancient Greek theater, concentric with the orchestra and the outer wall and communicating with the radial aisles.

### cercis

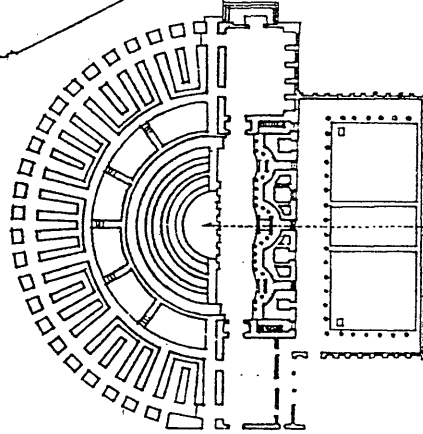
A wedge-shaped section of seats between two stepped passageways in an ancient Greek theater.

## Roman theater

An open-air theater modeled upon that of the ancient Greeks, but often built on level ground with colonnaded galleries, a semicircular orchestra, and a raised stage backed by an elaborate architectural structure.

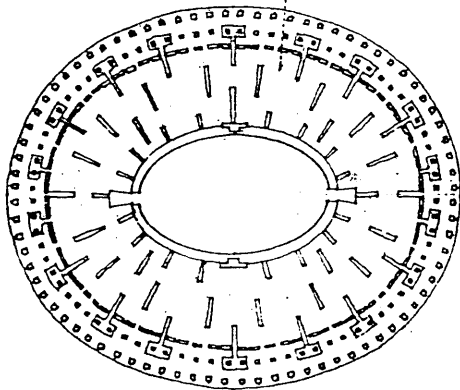
### orchestra

A semicircular space in the front of the stage of an ancient Roman theater, reserved for senators and other distinguished spectators.



### gradin

One of a series of steps or tiered seats, as in an amphitheater. Also, gradine.



## amphitheater

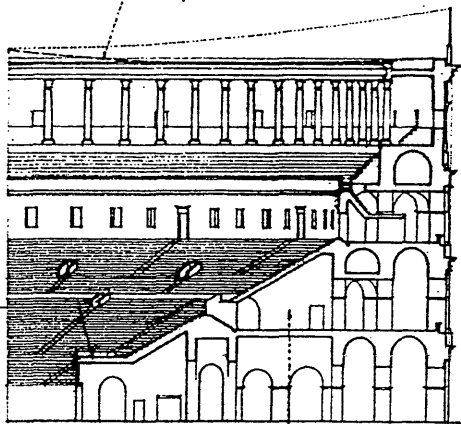
An oval or round building with tiers of seats around a central arena, as those used in ancient Rome for gladiatorial contests and spectacles.

### podium

A raised platform encircling the arena of an ancient Roman amphitheater, having on it the seats of privileged spectators.

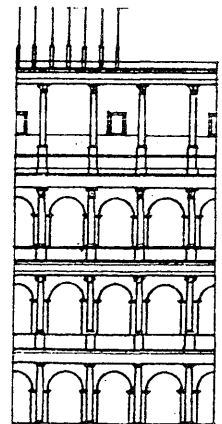
### velarium

A canvas awning drawn over an ancient Roman amphitheater to protect the audience from rain or sun.



### vomitory

A large opening, as in an ancient Roman amphitheater or stadium, permitting large numbers of people to enter or leave. Also, vomitorium.



### supercoluniation

The placing of one order of columns above another, usually with the more elaborate orders at the top.

**proscenium stage**  
A stage that is framed by a proscenium arch.

**proscenium arch**  
The arch that separates the stage from the auditorium. Also called proscenium.

**seating**  
The arrangement of seats in a theater, stadium, or other place of assembly.

**continental seating**  
A theater seating plan in which there is no center aisle, but with wide spacing between each row of seats to permit ease of passage.

**aisle**  
A walkway between or along sections of seats in a theater, auditorium, church, or other place of assembly.

**blind row**  
A row of seats having its first seat at a side aisle and its last seat at a side wall.

**stagehouse**  
The part of a theater on the stage side of the proscenium, including the stage, wings, and storage area.

**gridiron**  
A steel structure above the stage of a theater, from which hung scenery and equipment are manipulated. Also called grid.

**flies**  
The space above the stage used chiefly for storing and hanging scenery and equipment. Also called fly loft.

**bridge**  
A gallery or platform that can be raised or lowered over a stage and is used by technicians and stagehands.

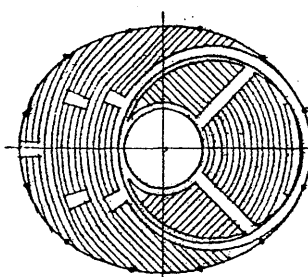
**batten**  
A length of metal pipe hung from the gridiron, for suspending scenery or equipment, as drop scenes, flats, or lighting units. Also called pipe batten.

**flat**  
A piece of scenery consisting of a wooden frame, usually rectangular, covered with lightweight board or fabric.

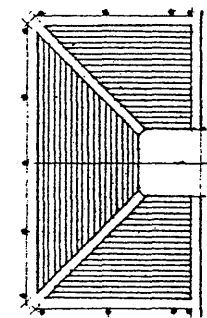
**orchestra shell**  
A sound-reflecting structure that closes off the flies and wings of a stage to form a performing area for music.

**stage**  
The platform, usually raised, on which the actors perform in a theater. Also, the platform and all the parts of a theater back of the proscenium.

**drop stage**  
A stage floor that moves vertically on an elevator, usually so that one set can quickly replace another. Also called lift stage.

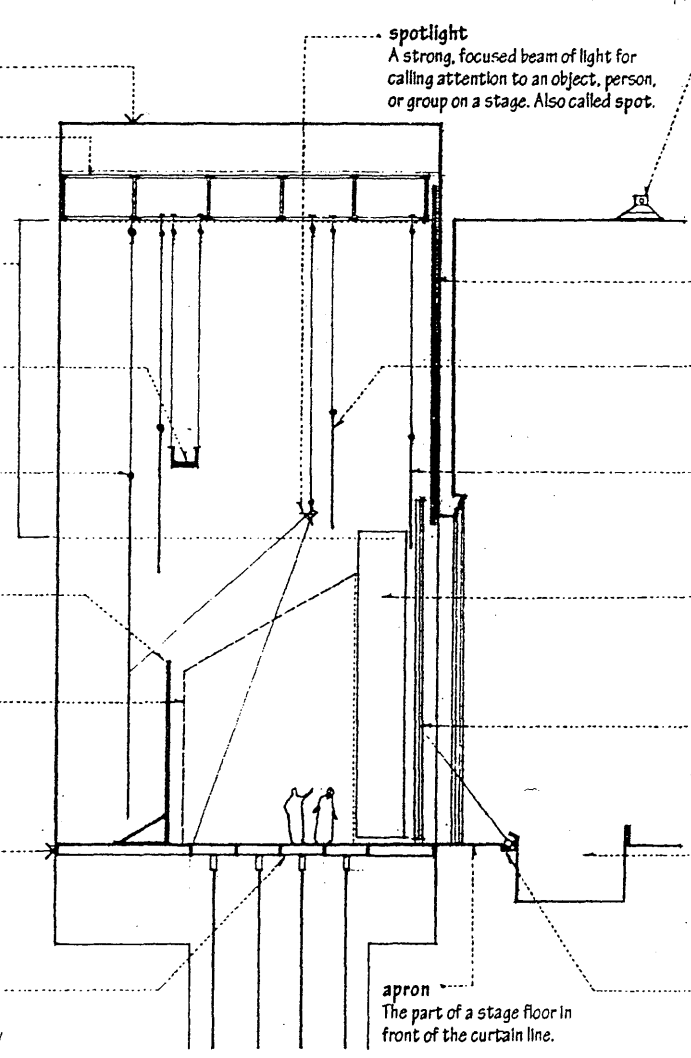


**surround theater**  
A theater or concert hall in which the seating is arranged around or on all four sides of a central stage.



**arena theater**  
A theater with seats arranged on at least three sides around a central stage. Also called theater-in-the-round.

**thrust stage**  
A stage that extends beyond the proscenium arch and is usually surrounded on three sides by seats.



**spotlight**  
A strong, focused beam of light for calling attention to an object, person, or group on a stage. Also called spot.

**houselights**  
The lamps providing illumination of an auditorium or the seating area of a theater.

**fire curtain**  
A curtain of asbestos or other fireproof material that can be lowered just inside the proscenium arch in case of fire, sealing off the backstage area from the auditorium. Also called safety curtain.

**border**  
A narrow curtain or strip of painted canvas hung above the stage to mask the flies and form the top of the stage set.

**teaser**  
A drapery or flat piece hung across the top of the proscenium arch to mask the flies and, together with the tormentors, frame the stage opening.

**tormentor**  
A curtain or framed structure used directly behind the proscenium at each side of the stage to screen the wings and sidelights from the audience.

**act curtain**  
A curtain for closing the proscenium opening between acts or scenes. Also called act drop, house curtain.

**orchestra pit**  
The space reserved for musicians, usually the front part of the main floor, sometimes wholly or partly under the forward part of the stage.

**apron**  
The part of a stage floor in front of the curtain line.

**footlights**  
The row of lights on the front of a stage, usually set in a trough, nearly on a level with the feet of the performers.

# THEATER

**opera house**  
A theater devoted chiefly to the public performance of operas.

**front of the house**  
The parts of a theater that are on the audience side of the fire wall.

**balcony**  
A gallery that projects over the main floor of a theater to accommodate additional people.

**gallery**  
An upper floor projecting over the main floor of a theater or hall.

**wing balcony**  
The part of a balcony that extends along the sidewalls of an auditorium.

**loge**  
A private seating area for a small group of spectators in a theater or opera house.

**peanut gallery**  
The rearmost and cheapest section of seats in the uppermost balcony of a theater.

**sight line**  
Any of the lines of sight between the spectators and the stage or playing area of a theater or stadium.

**dress circle**  
A curved or circular division of seats in a theater, opera house, or the like, usually the first gallery, originally set apart for spectators in evening dress.

**mezzanine**  
The lowest balcony or forward part of such a balcony in a theater.

**grand tier**  
The first tier of boxes immediately above the parterre in a large opera house or theater.

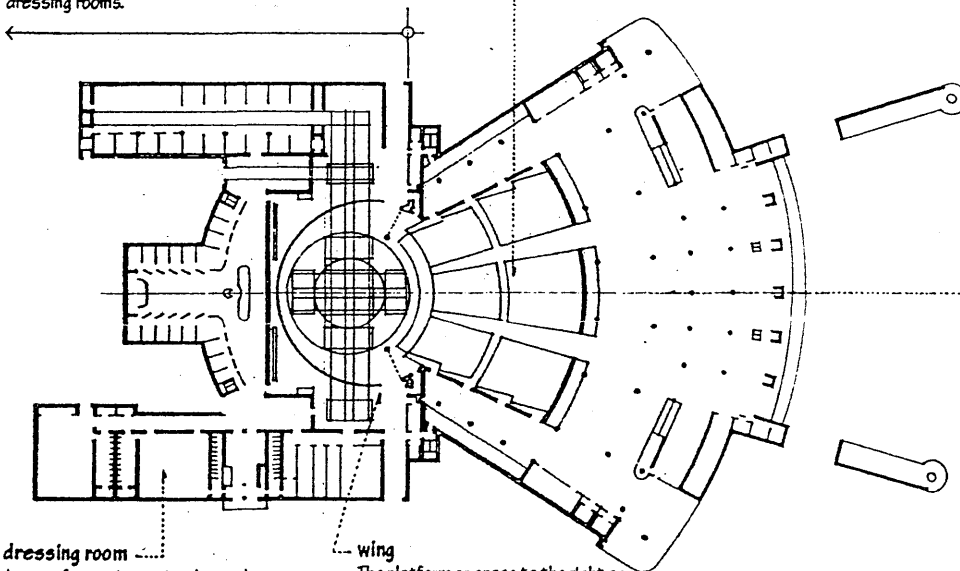
**tier**  
One of a number of galleries, as in a theater.

**orchestra**  
The entire main-floor space for spectators in a theater or auditorium.

**parterre**  
The rear section of seats, and sometimes also the side sections, of the main floor of a theater, opera house, or concert hall. Also called **parquet circle**.

**backstage**  
The area behind the proscenium in a theater, esp. in the wings and dressing rooms.

**auditorium**  
The space set apart for the audience in a theater or meeting hall.



**dressing room**  
A room for use in getting dressed, esp. one for performers backstage in a theater or television studio.

**wing**  
The platform or space to the right or left of the stage proper.

**lobby**  
A hall serving as a passageway or waiting room at or near the entrance to a theater, hotel, or apartment house. Also called **foyer**.

**lounge**  
A large public waiting room, as in a theater, hotel, or air terminal, often having adjoining washrooms.

**box office**  
The office of a theater or stadium at which tickets are sold.

**marquee**  
A tall rooflike projection above a theater entrance, usually containing the name of a currently featured play or film and its stars.

**green room**  
A lounge in a theater, concert hall, or broadcasting studio, for use by performers when they are not on stage.

**runway**  
A narrow platform or ramp extending from a stage into the orchestra pit or into an aisle of an auditorium.

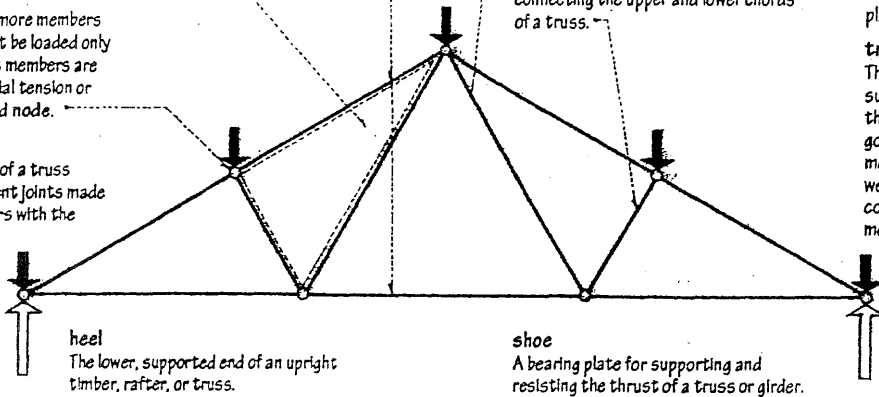
**panel**  
The space within the web of a truss between any two panel points on a chord and a corresponding pair of joints or a single joint on an opposite chord.

**panel point**  
A joint between two or more members of a truss. A truss must be loaded only at its panel points if its members are to be subject only to axial tension or compression. Also called node.

**panel length**  
The space on the chord of a truss between any two adjacent joints made by principal web members with the chord.

**chord**  
Either of the two principal members of a truss extending from end to end and connected by web members.

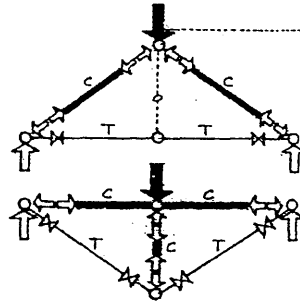
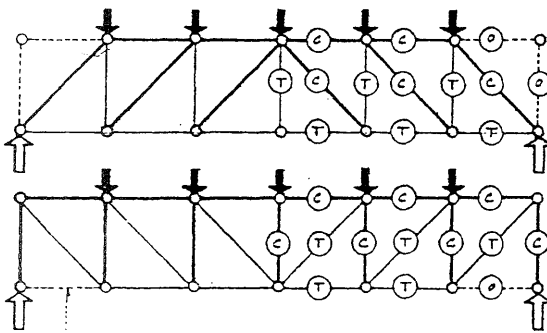
**web**  
The integral system of members connecting the upper and lower chords of a truss.



A structural frame based on the geometric rigidity of the triangle and composed of linear members subject only to axial tension or compression.

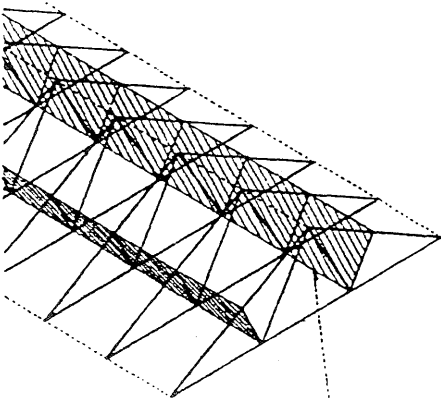
**plane truss**  
A truss all of whose members lie in a single plane.

**trussing**  
The rigid members forming a truss, subject to axial forces proportional to the rise of the truss. Buckling generally governs the size of compression members, while tensile stresses at the weakest points, usually at the connections, control the size of tension members.



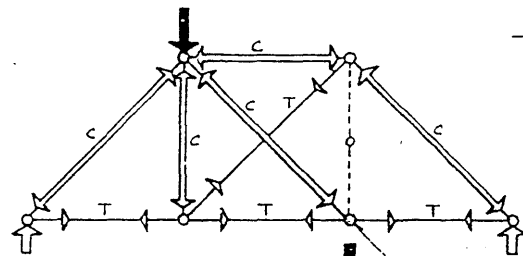
**panel load**  
A concentrated load applied to a panel point of a truss. To prevent secondary stresses from developing, the centroidal axes of truss members and the load at a joint should pass through a common point.

**zero-force member**  
A truss member that theoretically carries no direct load and whose omission would not alter the stability of the truss configuration.



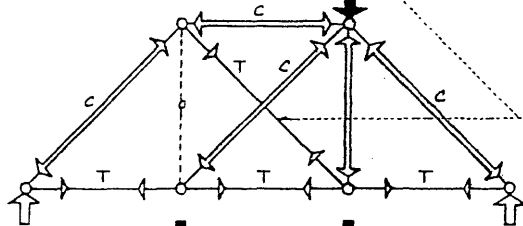
**direct stress**  
The tensile or compressive stress that is constant through the depth of a structural member subject to axial tension or compression.

**secondary stresses**  
Additional bending and shear stresses in a truss member resulting from an eccentric connection or a joint fixed against relative rotation. While trusses are assumed to have idealized pin connections, truss connections in reality may be bolted, welded, or riveted, imparting a degree of rigidity to the joints.



**stress reversal**  
A change in the force of a truss member from tension to compression or vice versa caused by a change in the loading pattern.

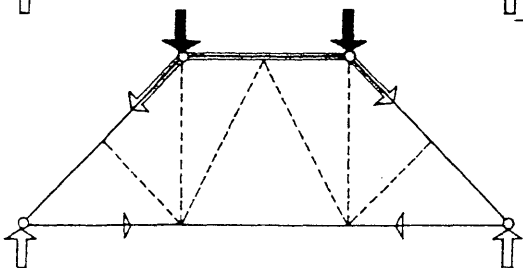
**counterbrace**  
A truss member subject to tension or compression under varying load conditions.

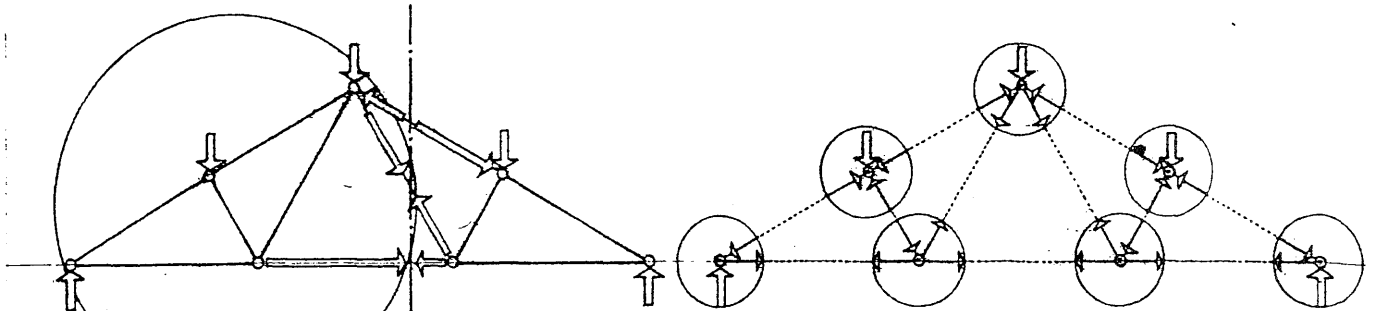


**trussing**  
A structure formed by trusses. While rigid in its own plane, a truss must be braced in a perpendicular direction to prevent lateral buckling.

**local buckling**  
The buckling of a thin compressed element of a structural member, leading to failure of the whole.

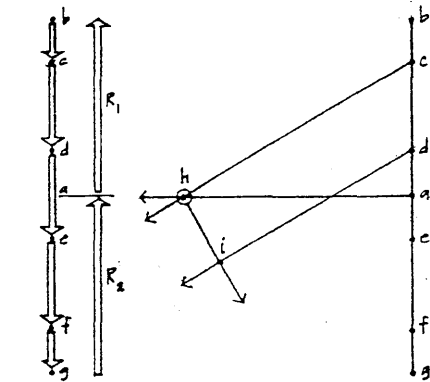
**funicular truss**  
A truss having an overall shape derived from the funicular shape for a particular set of loads. The interior members of a funicular truss are zero-force members which serve only to brace compression members but they will carry forces if any changes occur in the pattern or magnitude of the loads.





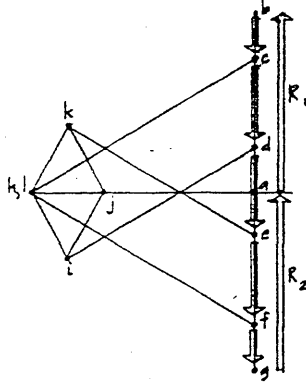
**method of sections**  
 A method for determining member forces in a truss by considering the equilibrium of any portion of the truss assembly.

**method of joints**  
 A method for determining member forces in a truss by considering the equilibrium of the various joints idealized as points in free-body diagrams.



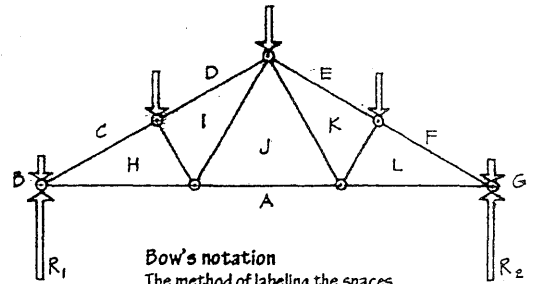
A force polygon for external forces and reactions is constructed first, followed by the construction of force polygons for the member forces at individual joints.

Since theoretically only axial forces are transmitted from one member to another at the joints, the direction of member forces can be drawn parallel to the truss members. Working from two known points, a third point of intersection can be found by projecting force lines of known direction.

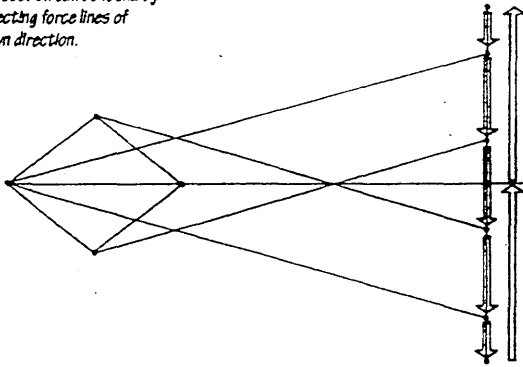


**Maxwell diagram**  
 A graphic method for determining the magnitude and character of the stresses in the members of a truss.

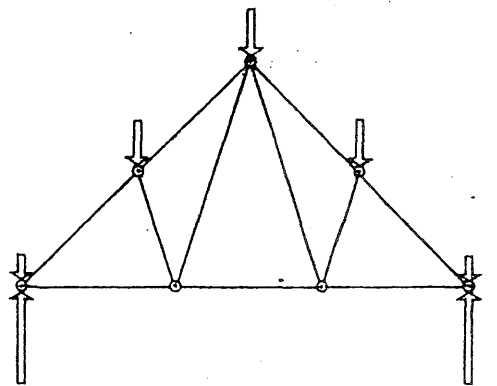
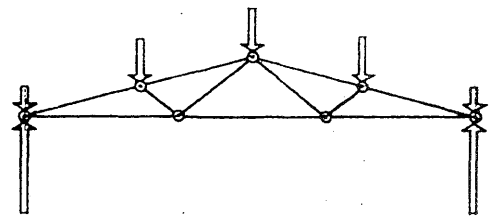
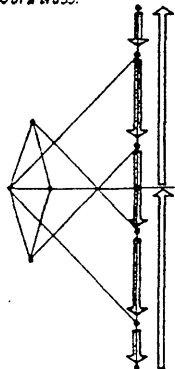
Capital letters designate panel spaces, while lowercase letters designate ends of the force vectors.



**Bow's notation**  
 The method of labeling the spaces between forces or their lines of action with letters, each force being identified by the two letters in the adjacent spaces when proceeding in a clockwise manner around a joint.

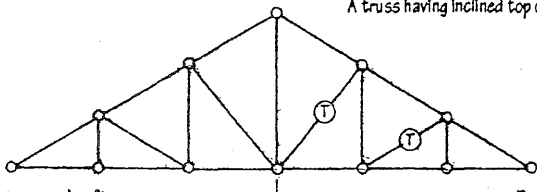


Member forces are inversely proportional to the rise of a truss.





**pitched truss**  
A truss having inclined top chords.



**flat truss**  
A truss having parallel top and bottom chords. Flat trusses are generally not as efficient as pitched or bowstring trusses. Also called parallel-chord truss.



**trussed rafter**  
A lightweight wood truss used in framing a roof, usually prefabricated of 2x4s and 2x6s joined with toothed plate connectors.

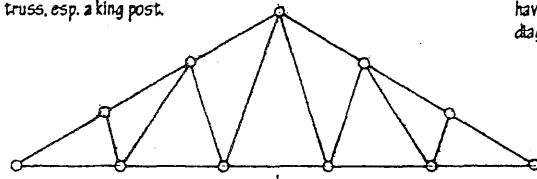
**Pratt**  
Of or pertaining to a flat or pitched truss having vertical web members in compression and diagonal web members in tension.

**trussed joist**  
A lightweight, flat wood truss used in framing a floor, usually prefabricated of 2x4s and 2x6s joined with toothed plate connectors.

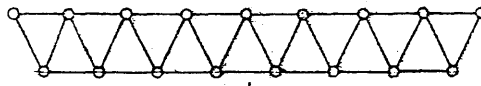


**crown post**  
Any vertical member in a pitched truss, esp. a king post.

**Howe**  
Of or pertaining to a flat or pitched truss having vertical web members in tension and diagonal web members in compression.



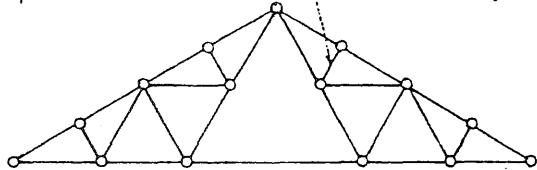
**Belgian**  
Of or pertaining to a pitched truss having only inclined web members.



**Warren**  
Of or pertaining to a flat or bowstring truss having inclined web members forming a series of equilateral triangles. Vertical web members are sometimes introduced to reduce the panel lengths of the top chord which is in compression.

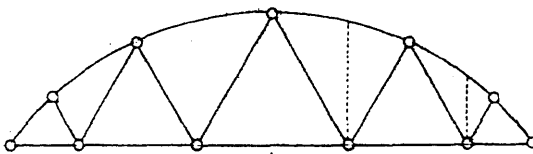
**diagonal**  
An inclined web member joining the top and bottom chords of a truss.

**subdiagonal**  
An inclined web member joining a chord with a main diagonal.

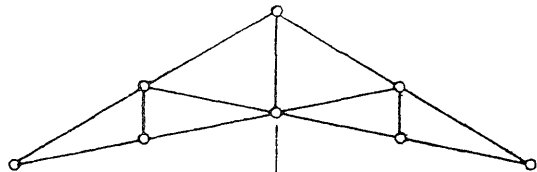


**fan truss**  
A truss having more than two web members radiating from a common point on the bottom chord.

**Fink truss**  
A Belgian truss having subdiagonals to reduce the length of compression web members toward the centerline of the span.

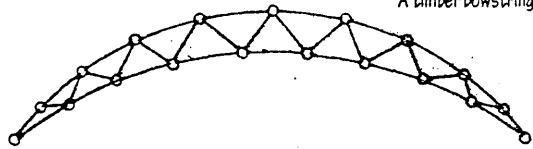


**bowstring truss**  
A truss having a curved top chord meeting a straight bottom chord at each end.



**raised-chord truss**  
A truss having a bottom chord raised substantially above the level of the supports.

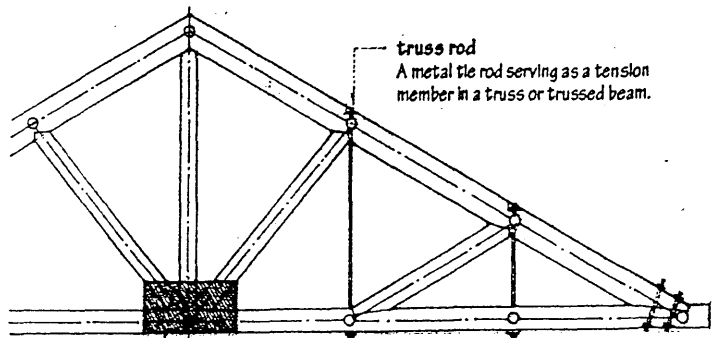
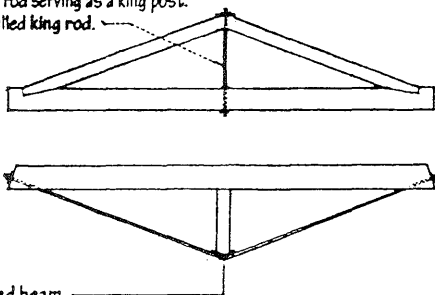
**scissors truss**  
A pitched truss having tension members extending from the foot of each top chord to an intermediate point on the opposite top chord.



**Belfast truss**  
A timber bowstring truss.

**kingbolt**  
A steel rod serving as a king post. Also called king rod.

**truss rod**  
A metal tie rod serving as a tension member in a truss or trussed beam.



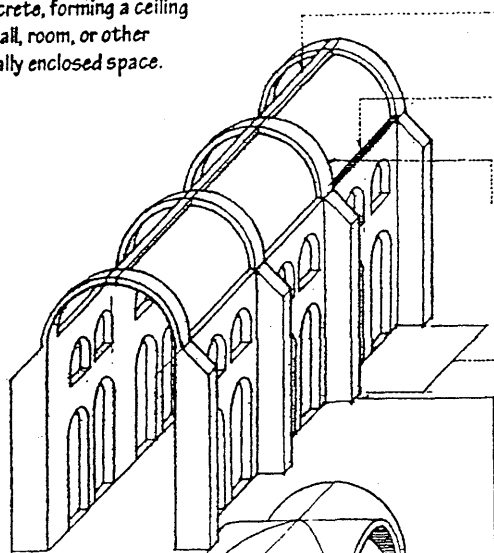
**trussed beam**  
A timber beam stiffened by a combination of diagonal truss rods and either compression struts or suspension rods.

**gusset**  
A plate for uniting structural members meeting in a single plane. Also called gusset plate.

**composite truss**  
A truss having timber compression members and steel tension members.

# VAULT

An arched structure of stone, brick, or reinforced concrete, forming a ceiling or roof over a hall, room, or other wholly or partially enclosed space.



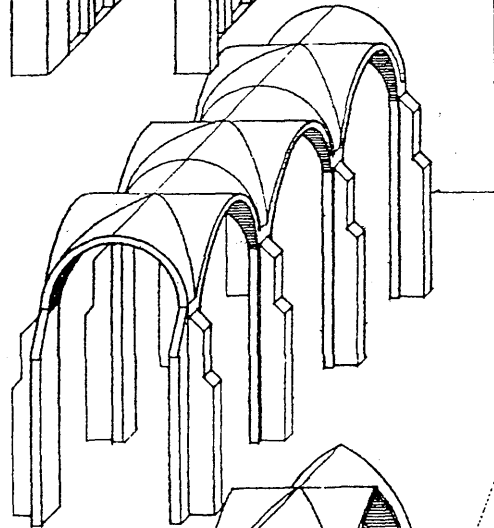
**key course**  
A course of keystones in the crown of a masonry vault.

**vaulting course**  
A horizontal course forming the abutments or springers of a masonry vault.

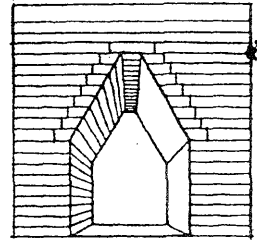
**transverse arch**  
An arch for stiffening a barrel vault or supporting a groin vault.

**severy**  
A bay between two transverse arches in a vaulted structure.

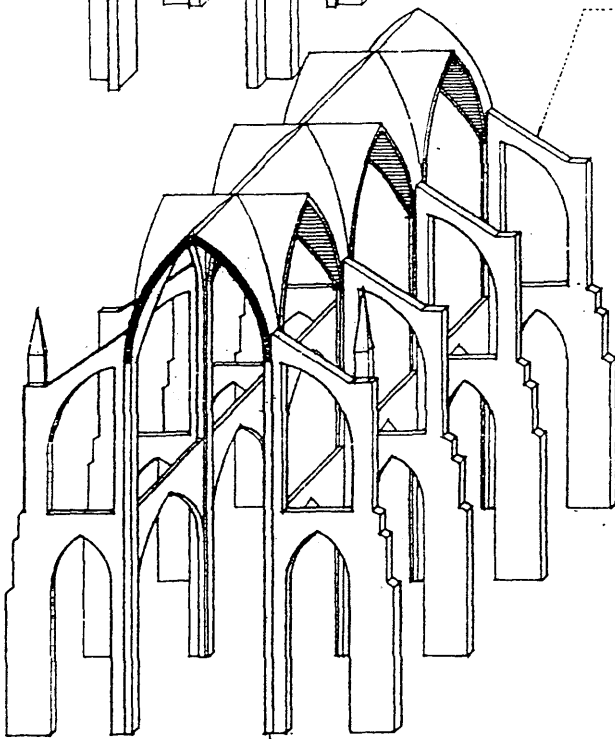
*Since it behaves as an arch extended in a third dimension, the longitudinal supporting walls must be buttressed to counteract the thrusts of the arching action.*



**buttress**  
An external support built to stabilize a structure by opposing its outward thrusts, esp. a projecting support built into or against the outside of a masonry wall.



**corbel vault**  
A vault constructed by corbeling courses of stone masonry. The resulting stepped surface can be smoothed or curved, but no arch action is incurred.



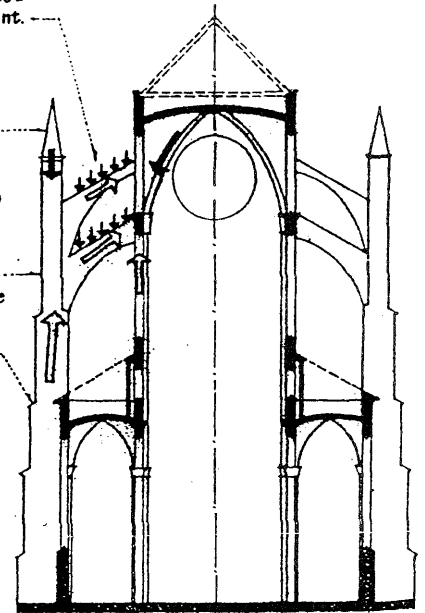
**flying buttress**  
An inclined bar of masonry carried on a segmental arch and transmitting an outward and downward thrust from a roof or vault to a solid buttress that through its mass transforms the thrust into a vertical one. Also called arc-boutant.

**pinnacle**  
A subordinate vertical structure terminating in a pyramid or spire, used esp. in Gothic architecture to add weight to a buttress pier.

**buttress pier**  
The part of a pier that rises to take the thrust of a flying buttress.

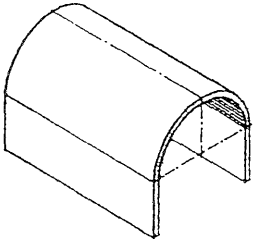
**amortizement**  
A sloping top on a buttress or projecting pier to shed rainwater.

**nosing**  
A projecting edge of a buttress.

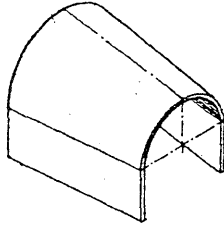


**shaft**  
A distinct, slender, vertical masonry feature engaged in a wall or pier and supporting or feigning to support an arch or a ribbed vault.

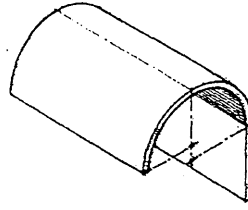
**vaulting shaft**  
A shaft that leads to the springer of a rib or group of ribs, either rising from the ground or from a corbel at a greater height in the face of the masonry.



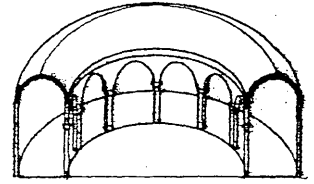
**barrel vault**  
A vault having a semicircular cross section. Also called *cradle vault*, *tunnel vault*, *wagon vault*.



**conical vault**  
A vault having a circular cross section that is larger at one end than the other.

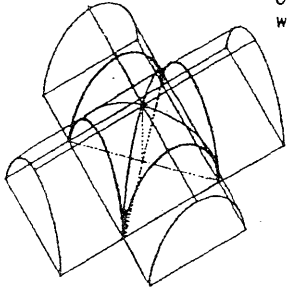


**rampant vault**  
A vault springing from an abutment higher at one side than at the other.

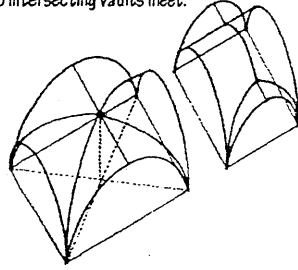


**annular vault**  
A barrel vault having a circular plan in the shape of a ring.

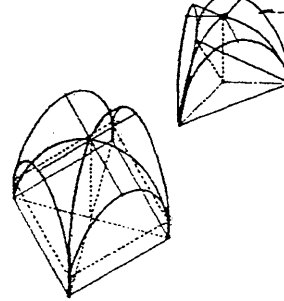
**groin**  
One of the curved lines or edges along which two intersecting vaults meet.



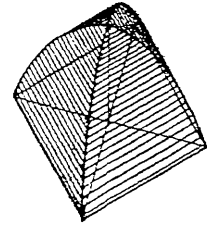
**groin vault**  
A compound vault formed by the perpendicular intersection of two vaults, forming arched *diagonal arrises* called *groins*. Also called *cross vault*.



**underpitch vault**  
A compound vault having a central vault intersected by vaults of lower pitch. Also called *Welsh vault*.

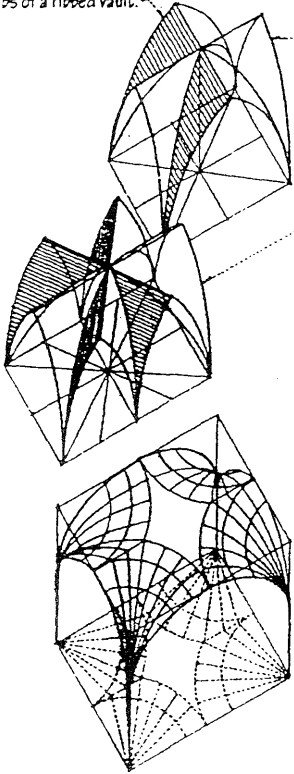


**tripartite vault**  
A compound vault for covering a triangular space, formed by the intersection of three barrel vaults.



**cloister vault**  
A compound vault formed by four *coes* meeting along diagonal vertical planes. Also called *coved vault*.

**web**  
A surface framed by the ribs of a ribbed vault.



**rib vault**  
A vault supported by or decorated with arched diagonal ribs. Also, *ribbed vault*.

**quadrupartite vault**  
A rib vault divided into four parts by intersecting diagonal ribs.

**sexpartite vault**  
A rib vault divided into six compartments by two diagonal ribs and three transverse ribs.

**rib**  
Any of several archlike members supporting a vault at the groins, defining its distinct surfaces or dividing these surfaces into panels.

**arc doubleau**  
A rib spanning the longitudinal axis of a rib vault and dividing it into bays or compartments. Also called *transverse rib*.

**tierceron**  
A rib springing from a point of support on either side of the ogives or transverse ribs of a rib vault. Also called *intermediate rib*.

**formeret**  
A rib against a wall, parallel to the longitudinal axis of a rib vault. Also called *wall rib*.

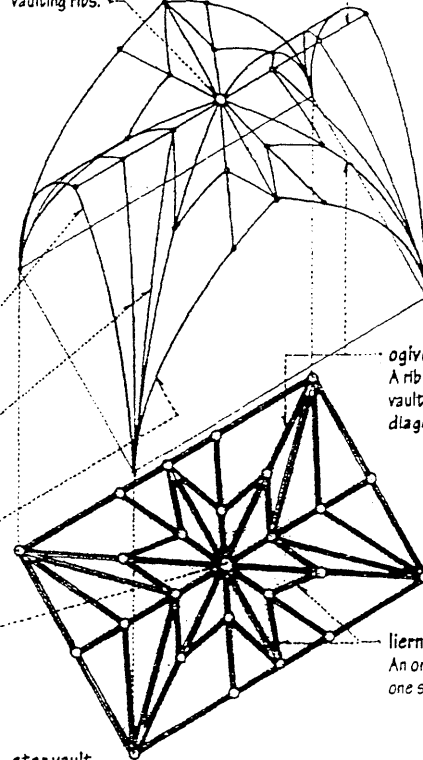
**boss**  
An ornamental, knoblike projection, as a carved keystone at the intersection of ogives.

**pendant**  
A sculptured ornament suspended from a roof truss, vault, or ceiling. Also called *drop*.

**fan vault**  
A vault composed of a number of concave conoidal sections, usually four, springing from the corners of the vaulting compartment, often decorated with ribs that radiate from the springing like the framework of a fan.

**key**  
The keystone at the crown of an arch or at the intersection of two or more vaulting ribs.

**ridge rib**  
A horizontal rib marking the crown of a vaulting compartment.



**ogive**  
A rib crossing a compartment of a rib vault on a diagonal. Also called *diagonal rib*, *groin rib*.

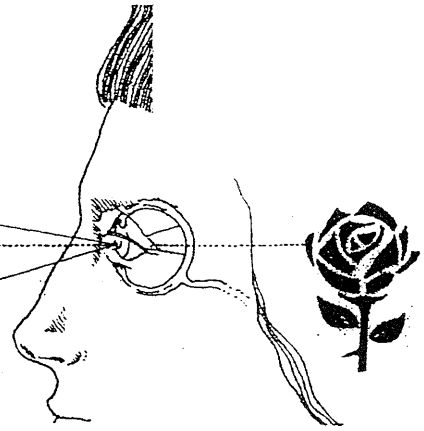
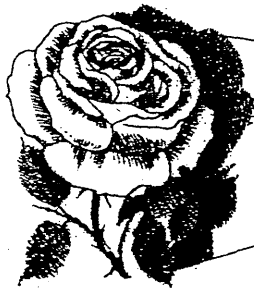
**lierne**  
An ornamental vaulting rib other than one springing from a pier or a ridge rib.

**star vault**  
A vault having ribs, liernes, or tiercerons arranged in a star-shaped pattern. Also called *stellar vault*.

# VISION

**Sight:** the act or power of sensing with the eyes.

**see**  
To perceive with the eyes. The act of seeing is a dynamic and creative process. It is capable of delivering a stable, three-dimensional perception of the moving, changing images which make up our visual world. There are three steps in the swift and sophisticated processing which results in the images we see.



reception: our eyes receive energy input in the form of light.

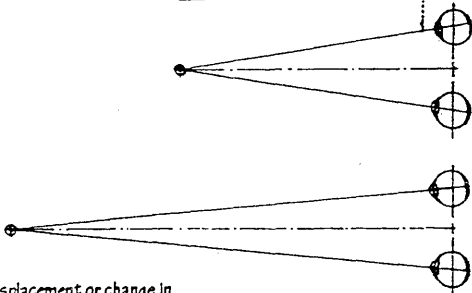
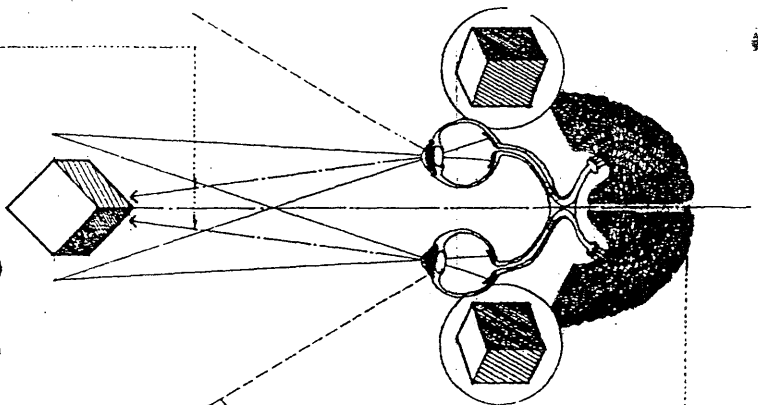
extraction: basic visual features are extracted from this input.

inference: on the basis of these extracted features, inferences are made about our world.

**binocular vision**  
The three-dimensional, stereoscopic vision resulting from the use of both eyes at the same time.

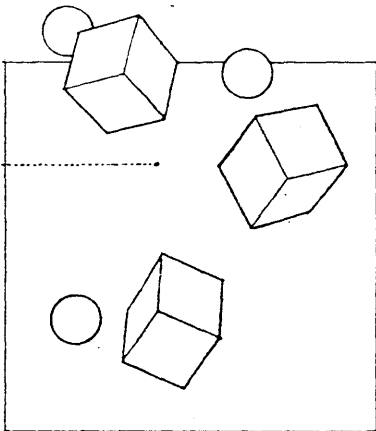
**convergence**  
The coordinated turning of the eyes inward to focus on a nearby point.

**accommodation**  
The process by which the human eye changes focus for objects at various distances, involving changes in the shape of the crystalline lens.



**parallax**  
The apparent displacement or change in direction of an observed object caused by a change in the position of the observer that provides a new line of sight.

**visuospatial**  
Pertaining to perception of the spatial relationships among objects within the field of vision.

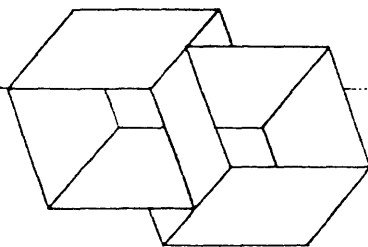


**orientation**  
The ability to locate oneself in one's environment with reference to time, place, and people.

**visual literacy**  
The ability to apprehend and interpret pictures, drawings, or other visual images.

**eye**  
Apperceptive or discriminating visual perception.

**optical illusion**  
A perception of visual stimuli that represents what is perceived in a way different from the way it is in reality.



**field of vision**  
The entire field encompassed by the human eye when it is trained in any particular direction. Also called visual field.

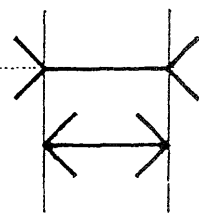
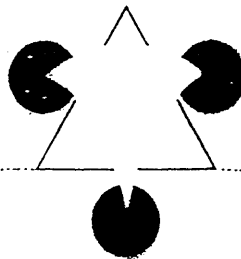
**visual angle**  
The angle that an object or detail subtends at the point of observation, usually measured in minutes of arc.

**visual cortex**  
The portion of the cerebral cortex of the brain that receives and processes impulses from the optic nerves.

**visual acuity**  
Acuteness of vision as determined by a comparison with the normal ability to define certain letters at a given distance, usually 20 ft. (6 m).

**discrimination**  
The ability or power to see or make fine distinctions.

**aspect**  
Appearance to the human eye or mind.



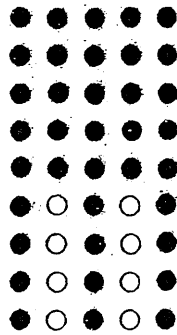
**camouflage**

The obscuring of a form or figure that occurs when its shape, pattern, texture, or coloration is similar to that of its surrounding field or background.



**projection**

A property of perception in which the mind's eye searches for meaning by imagining and projecting known or familiar images onto the seemingly amorphous shapes of a pattern until it finds a match which makes sense. This attempt to complete an incomplete pattern, or find a meaningful pattern embedded in a larger one, is in accordance with what we already know or expect to see. Once seen and understood, it is difficult to not see the image.



**similarity**

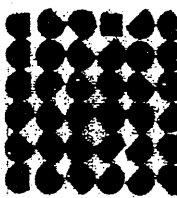
A property of perception in which there is a tendency to group things which have some visual characteristic in common, as a similarity of shape, size, color, orientation or detail.

**proximity**

A property of perception in which there is a tendency to group elements which are close together, to the exclusion of those which are further away.

**continuity**

A property of perception in which there is a tendency to group elements which continue along the same line or in the same direction. This search for continuity of line and direction can also lead to our perception of the simpler, more regular figures or patterns in a composition.

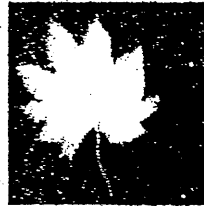
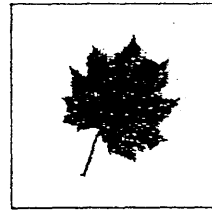
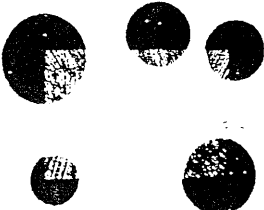


**constancy**

A perceptual phenomenon in which apparent differences in size are ignored in order to identify and categorize things, regardless of how distant they are, leading to the perception of a class of objects as having uniform size and constant color and texture.

**closure**

A property of perception in which there is a tendency for an open or incomplete figure to be seen as if it were a closed or complete and stable form.



**perception**

The act or faculty of apprehending by means of the senses or of the mind.

**visual perception**

An awareness derived by the visual system in response to an external stimulus.

**figure-ground**

A property of perception in which there is a tendency to see parts of a visual field as solid, well-defined objects standing out against a less distinct background.

**figure**

A shape or form, as determined by outlines or exterior surfaces.

**ground**

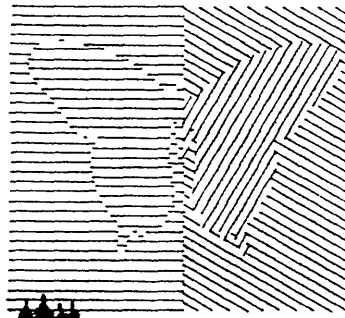
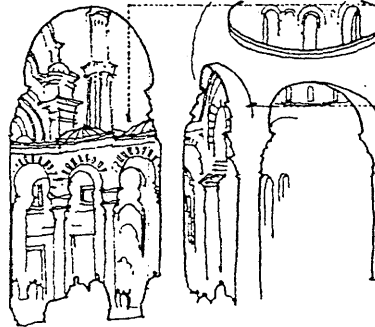
The receding part of a visual field against which a figure is perceived. Also called background.

**background**

The parts or portion of a scene, situated in the rear, as opposed to foreground.

**foreground**

The parts or portion of a scene situated in the front, nearest to the viewer.



**Gestalt psychology**

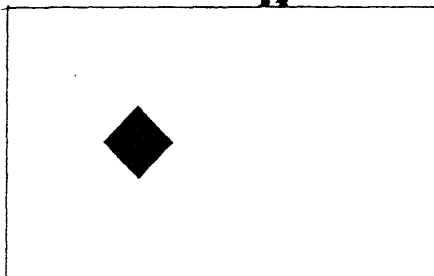
The theory or doctrine that physiological or psychological phenomena do not occur through the summation of individual elements, as reflexes or sensations, but through gestalts functioning separately or interrelatedly. Also called configurationism.

**gestalt**

A unified configuration, pattern, or field of specific properties that cannot be derived from the summation of the component parts.

**pattern**

A consistent, characteristic, or coherent arrangement based on the interrelation of component parts.

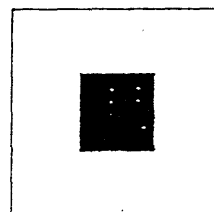
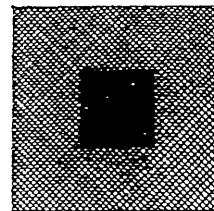


**successive contrast**

A phenomenon of visual perception in which intense exposure to one color or value leads to the sensation of its complement, which is projected as an afterimage on another color or surface viewed immediately thereafter.

**afterimage**

A visual sensation that persists after the stimulus that caused it is no longer operative or present.



**simultaneous contrast**

A phenomenon of visual perception in which the stimulation of one color or value leads to the sensation of its complement, which is projected instantaneously on a juxtaposed color or value. Simultaneous contrast intensifies complementary colors and shifts analogous colors toward each other's complementary hue, esp. when the juxtaposed colors are similar in value. When two colors of contrasting value are juxtaposed, the lighter color will deepen the darker color while the darker color will lighten the lighter one.

# WALL

Any of various upright constructions presenting a continuous surface and serving to enclose, divide, or protect an area.

**bearing wall**  
A wall capable of supporting an imposed load, as from a floor or roof of a building. Also called **load-bearing wall**.

**nonbearing wall**  
A wall supporting no load other than its own weight. Also called **non-load-bearing wall**.

**canton**  
A plaster or similar feature projecting from a corner of a building.

**pilaster**  
A shallow rectangular feature projecting from a wall, having a capital and a base and architecturally treated as a column.

**engaged column**  
A column built so as to be truly or seemingly bonded to the wall before which it stands.

**return wall**  
A short wall perpendicular to the end of a longer wall.

**pier**  
A vertical supporting structure, as a section of wall between two openings or one supporting the end of an arch or lintel.

**discharging arch**  
An arch built above another structural member to relieve its load. Also called **relieving arch**.

**lintel**  
A beam supporting the weight above a door or window opening.

**template**  
A horizontal timber or stone set in a wall to receive and distribute the pressure of a girder or beam, as over an opening. Also, **templet**.

**exterior wall**  
A wall forming part of the envelope of a building, having one face exposed to the weather or to earth. Also called **external wall**.

**interior wall**  
Any wall within a building, entirely surrounded by exterior walls.

**partition**  
An interior wall dividing a room or part of a building into separate areas.

**bearing partition**  
An interior wall carrying a structural load. Also called **load-bearing partition**.

**nonbearing partition**  
An interior wall supporting no load other than its own weight. Also called **non-load-bearing partition**.

**screen**  
A movable or fixed device, esp. a framed construction, designed to divide, conceal, or protect.

**movable partition**  
A partition capable of being moved to different locations. Also called **demountable partition**.

**coping**  
A finishing or protective cap or course to an exterior wall, usually sloped or curved to shed water.

**splayed coping**  
A coping that slopes only in one direction. Also called **wedge coping**.

**saddle coping**  
A coping that slopes to either side of a center ridge. Also called **saddlebacked coping**.

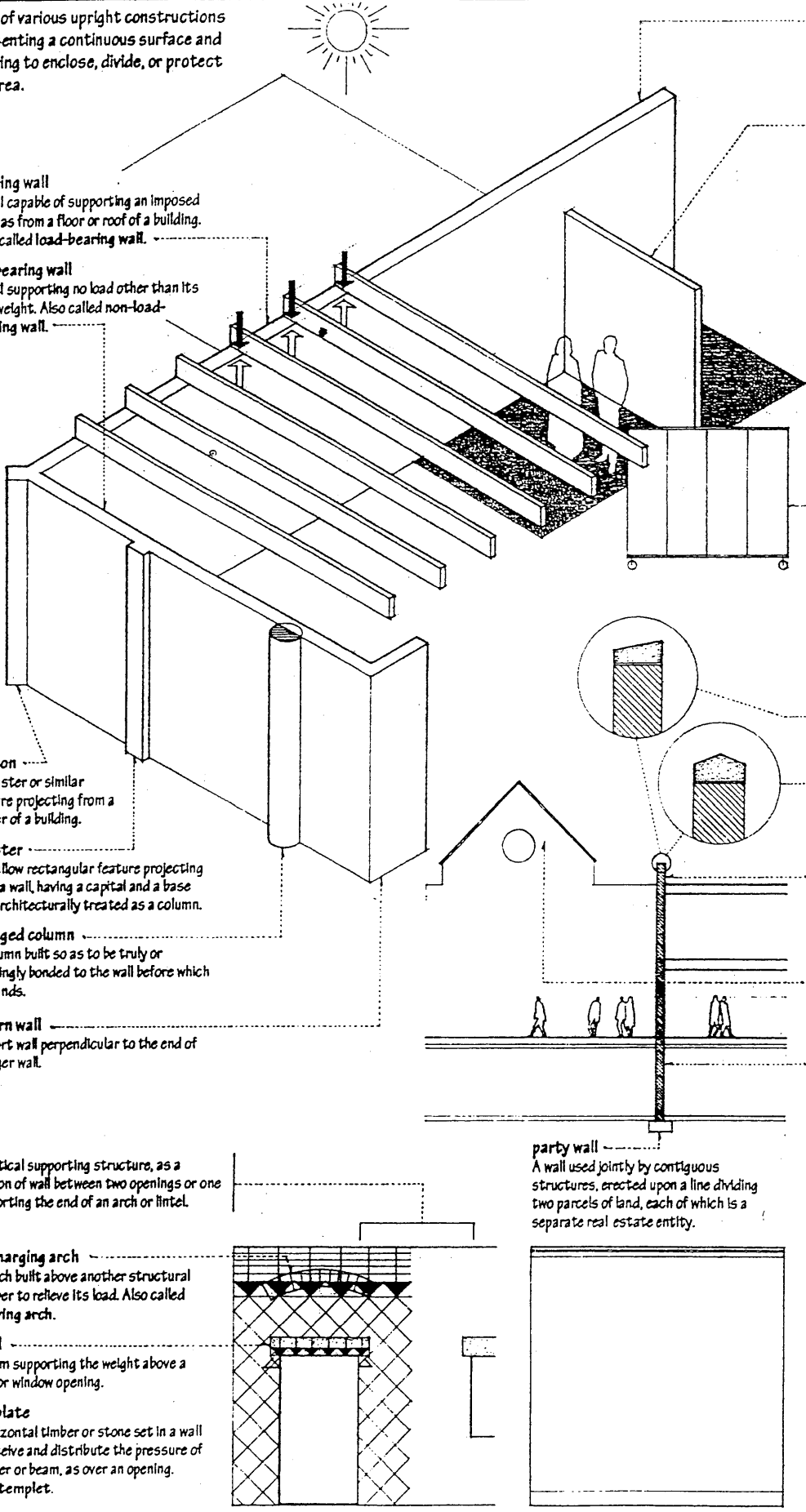
**parapet**  
A low, protective wall at the edge of a terrace, balcony, or roof, esp. that part of an exterior wall, fire wall, or party wall that rises above the roof.

**gable wall**  
A wall bearing or crowned by a gable.

**basement wall**  
A foundation wall that encloses a usable area under a building.

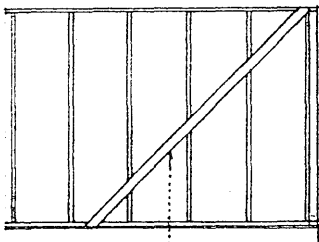
**party wall**  
A wall used jointly by contiguous structures, erected upon a line dividing two parcels of land, each of which is a separate real estate entity.

**blind wall**  
A wall having no windows, doorways, or other openings.



**frame house**

A house constructed with a skeletal framework of timber, usually sheathed with siding or shingles.



**corner brace**

A diagonal brace let into studding to reinforce the corner of a frame structure.

**let in**

To insert into the surface of a stud, wall, or the like as a permanent addition.

**corner post**

An assembly of two or three studs spiked together at the intersection of two framed walls to provide a nailing surface for finish materials.

**backing**

A narrow wood strip fixed to the corner of a framed partition to provide a nailing surface for finish materials.

**firestop**

A material or member built into a building frame to block a concealed hollow space through which a fire might spread from one part of the building to another.

**ledger strip**

A piece attached to the face of a beam at the bottom as a support for the ends of joists.

**ribbon**

A thin, horizontal board let into studding to carry the ends of joists. Also called ledger, ribband, ribbon strip.

**balloon frame**

A wooden building frame having studs that rise the full height of the frame from the sill plate to the roof plate, with joists nailed to the studs and supported by sills or by ribbons let into the studs.

**plate**

Any of various horizontal timbers laid flat across the heads of studding or upon floors to support joists, rafters, or studs at or near their ends.

**wall plate**

A horizontal member built into or laid along the top of a wall to support and distribute the load from joists or rafters. Also called raising plate.

**top plate**

The uppermost horizontal member of a framed wall on which joists or rafters rest.

**blocking**

A number of small wood pieces inserted to space, join, or reinforce members of a building frame, fill the spaces between them, or provide a nailing surface for finish materials.

**stud wall**

A wall or partition framed with studs and faced with sheathing, siding, wallboard, or plasterwork. Also called stud partition.

**stud**

Any of a series of slender, upright members of wood or metal forming the structural frame of a wall or partition.

**cripple**

Any framing member that is shorter than usual, as a stud above a door opening or below a window sill.

**center-to-center**

From the centerline of one element, member, or part to the centerline of the next. Also called on center.

**soleplate**

The bottom horizontal member of a framed wall upon which a row of studs is erected. Also called shoe, sole, solepiece.

**platform frame**

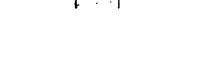
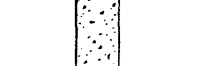
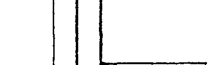
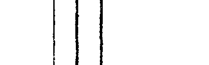
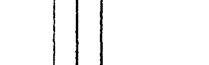
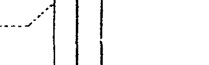
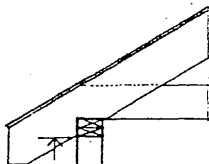
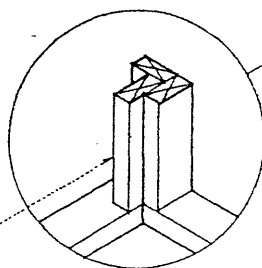
A wooden building frame having studs only one story high, regardless of the stories built, each story resting on the top plates of the story below or on the sill plates of the foundation wall. Also called western frame.

**pony wall**

A dwarf wall for supporting floor joists.

**dwarf wall**

A wall less than a full story in height.



**anchor bolt**

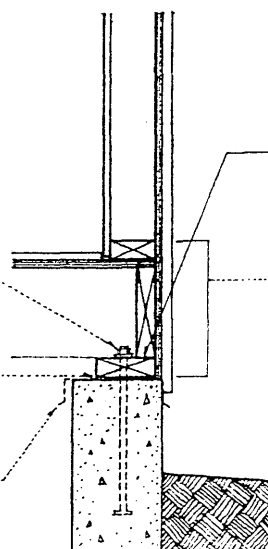
Any of various rods or bolts embedded in masonry or concrete to hold, secure, or support a structural member.

**sill sealer**

A resilient, fibrous material placed between a sill and a foundation wall to reduce air infiltration.

**termite shield**

Sheet metal installed atop a foundation wall or around pipes to prevent the passage of termites.



**sill**

The lowest horizontal member of a frame structure, resting on and anchored to a foundation wall. Also called mudsill, sill plate.

**box sill**

A sill for a building frame, composed of a plate resting on a foundation wall and a joist or header at the outer edge of the plate, as well as a soleplate for studs resting either directly on the joists or on the rough flooring.

**L sill**

A sill for a building frame, composed of a plate resting on a foundation wall and a joist or header at the outer edge of the plate.

# WALL

## siding

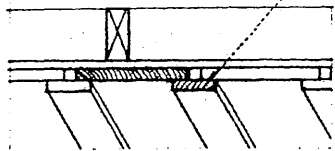
A weatherproof material, as shingles, boards, or units of sheet metal, used for surfacing the exterior walls of a frame building.

## corner board

A board against which siding is fitted at the corner of a frame structure.

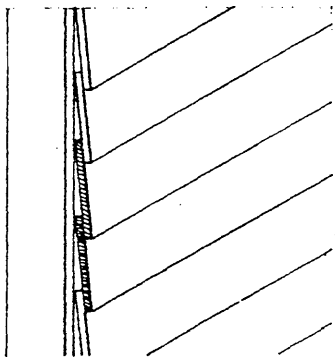
## batten

A small board or strip of wood used for various building purposes, as to cover joints between boards, support shingles or roofing tiles, or provide a base for lathing.



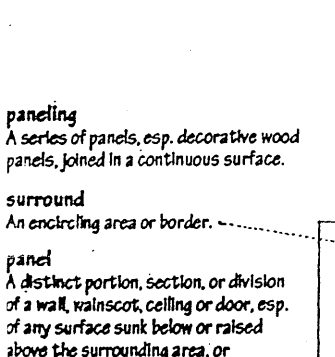
## board and batten

Siding consisting of wide boards or plywood sheets set vertically with butt joints covered by battens.



## colonial siding

Siding composed of plain, square-edged boards laid horizontally so that the upper overlaps the one below.



## wainscot

A facing of wood paneling, esp. when covering the lower portion of an interior wall.

## nullion

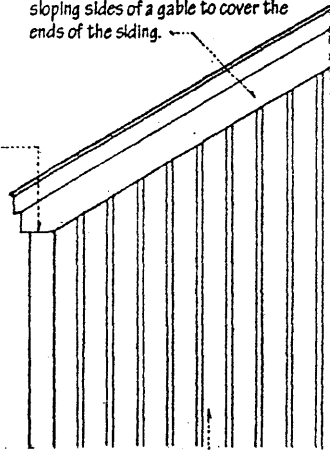
Vertical member dividing the panels in wainscoting.

## ado

The lower portion of an interior wall when faced or treated differently from the upper section, as with paneling or wallpaper.

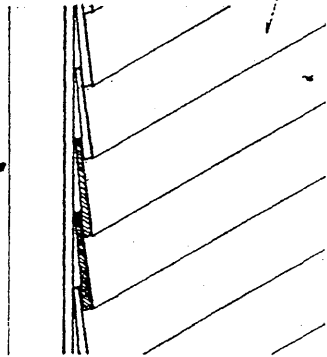
## rake

A board or molding placed along the sloping sides of a gable to cover the ends of the siding.



## vertical siding

Siding consisting of matched boards applied vertically.

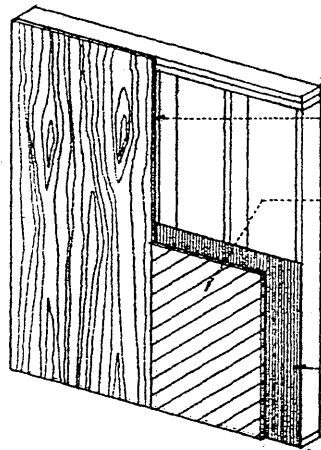
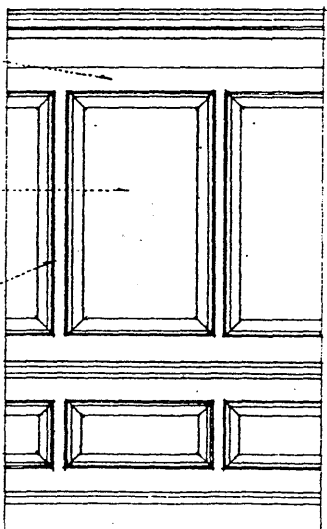


## bevel siding

Siding composed of tapered boards, as clapboards, laid horizontally with the thicker lower edge of each board overlapping the thinner upper edge of the board below it. Also called lap siding.

## flush panel

A panel having a surface in the same plane as the surrounding frame.



## sheathing

A rough covering of boards, plywood, or other panel materials applied to a frame structure to serve as a base for siding, flooring, or roofing.

## structural sheathing

Sheathing capable of bracing the plane of a framed wall or roof.

## diagonal sheathing

A sheathing of boards applied diagonally for lateral strength.

## boarding

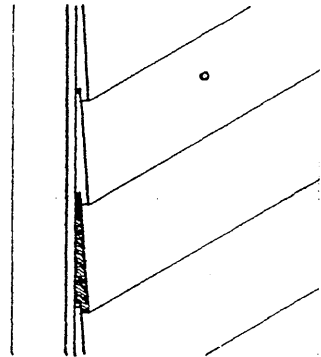
A structure of boards, as for sheathing or subflooring.

## building paper

Any of various papers, felts, or similar sheet material used in construction to prevent the passage of air or moisture.

## clapboard

A long, thin board with one edge thicker than the other, laid horizontally as bevel siding.

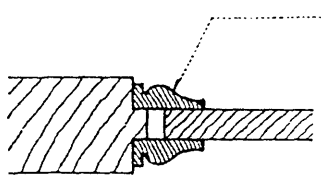
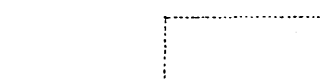


## Dolly Yarden siding

Bevel siding rabbeted along the lower edge to receive the upper edge of the board below it.

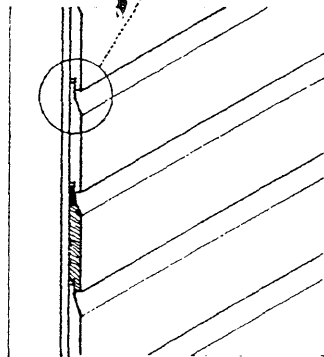
## raised panel

A panel having a center portion thicker than the edges or projecting above the surrounding frame. Also called fielded panel.



## shiplap

A flush, overlapping joint, as a rabbet, between two boards joined edge to edge. Also, the boarding joined with such overlapping joints.



## drop siding

Siding composed of boards narrowed along the upper edges to fit into rabbets or grooves in the lower edges, laid horizontally with their backs flat against the sheathing or studs of the wall. Also called novelty siding, rustic siding.

## sunk panel

A panel having a surface recessed below the surrounding frame or surface.

## flush bead

A bead having its outer surface at the same level as the adjoining surfaces.

## cock bead

A bead that projects above or beyond the adjoining surfaces.

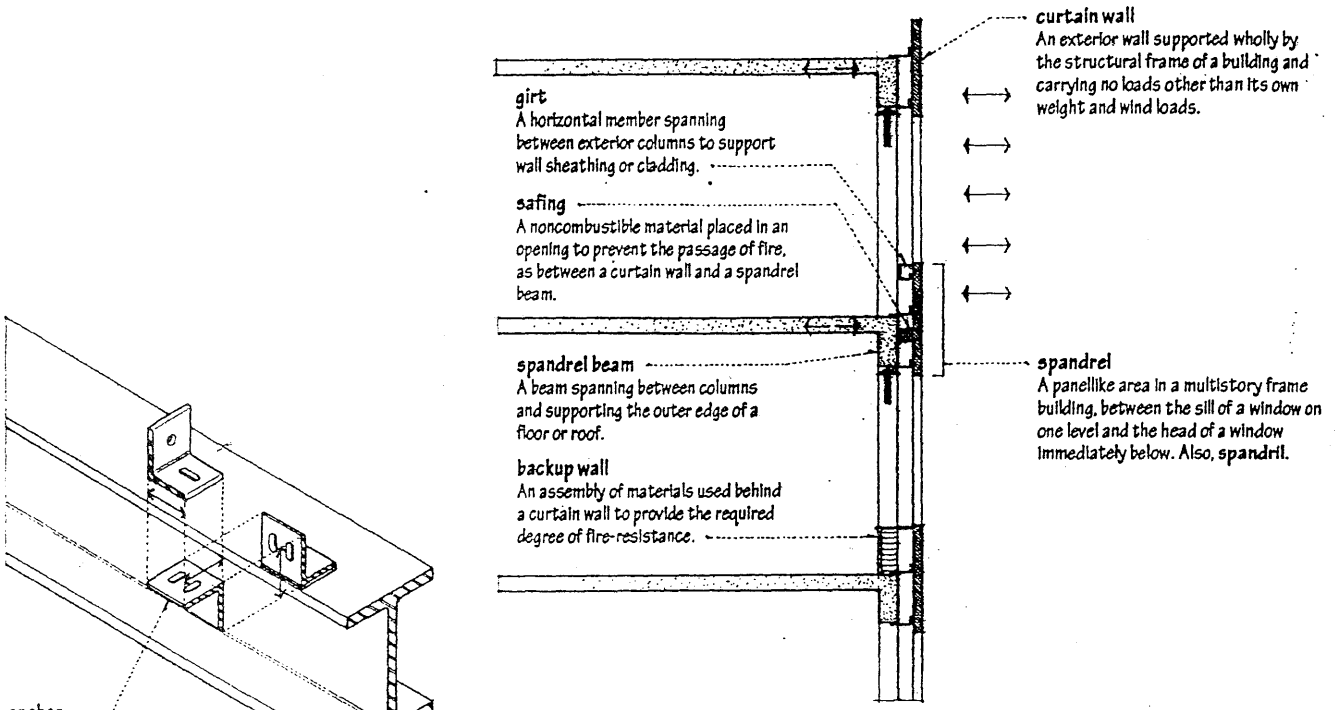
## quirk

A groove or acute angle dividing a bead or other molding from adjoining members or surfaces.

## bolelection

A raised molding for framing a panel, doorway, or fireplace, esp. when the meeting surfaces are at different levels. Also, bilelection.





**girt**  
A horizontal member spanning between exterior columns to support wall sheathing or cladding.

**safing**  
A noncombustible material placed in an opening to prevent the passage of fire, as between a curtain wall and a spandrel beam.

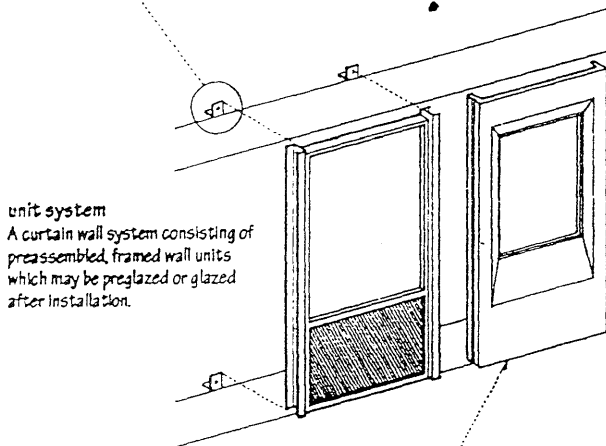
**spandrel beam**  
A beam spanning between columns and supporting the outer edge of a floor or roof.

**backup wall**  
An assembly of materials used behind a curtain wall to provide the required degree of fire-resistance.

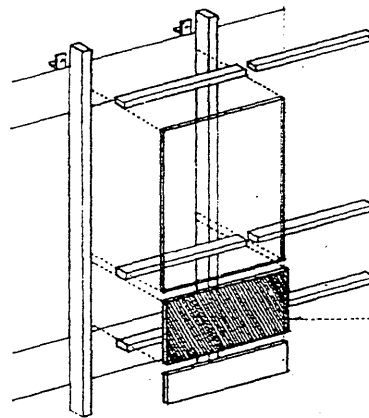
**curtain wall**  
An exterior wall supported wholly by the structural frame of a building and carrying no loads other than its own weight and wind loads.

**spandrel**  
A panellike area in a multistory frame building, between the sill of a window on one level and the head of a window immediately below. Also, spandril.

**anchor**  
Any of various metal devices used in curtain wall construction to secure a frame or panel to the building structure, usually allowing for adjustment in three dimensions.

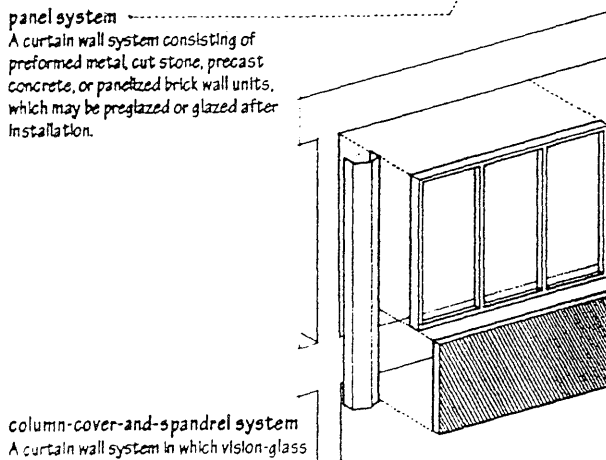


**unit system**  
A curtain wall system consisting of preassembled, framed wall units which may be preglazed or glazed after installation.

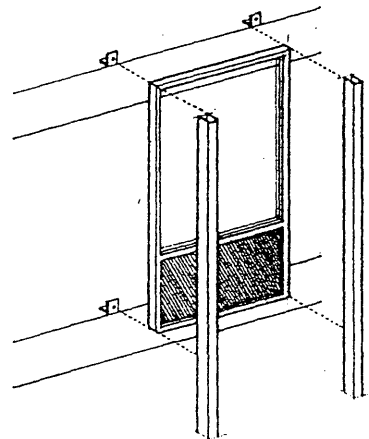


**stick system**  
A curtain wall system in which tubular metal mullions and rails are assembled piece by piece on-site to frame vision glass and spandrel units.

**spandrel glass**  
An opaque glass for concealing the structural elements in curtain wall construction, produced by fusing a ceramic frit to the interior surface of tempered or heat-strengthened glass.



**panel system**  
A curtain wall system consisting of preformed metal, cut stone, precast concrete, or paneled brick wall units, which may be preglazed or glazed after installation.

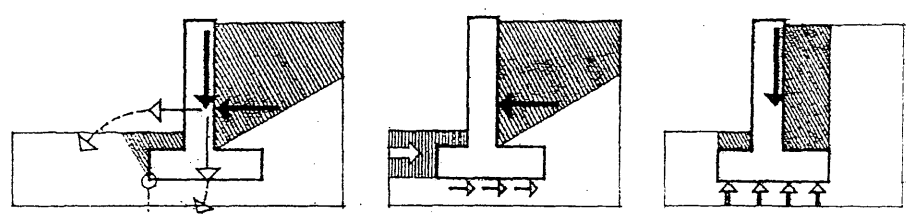


**unit-and-mullion system**  
A curtain wall system in which one- or two-story-high mullions are installed before preassembled wall units are lowered into place behind the mullions. The framed wall units may be preglazed or glazed after installation.

**column-cover-and-spandrel system**  
A curtain wall system in which vision-glass assemblies and spandrel units are supported by spandrel beams between exterior columns clad with cover sections.

# WALL

**retaining wall**  
A wall of treated timber, masonry, or concrete for holding in place a mass of earth. A retaining wall can fall by overturning, sliding, or settling. Also called breast wall.

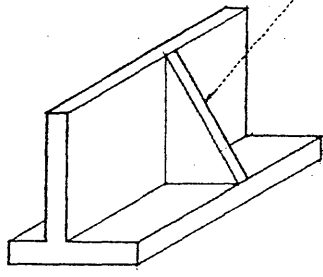
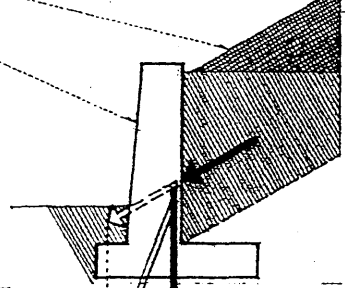


**surcharge**  
An additional or excessive load or burden, as that of the earth above the level of the top of a retaining wall.

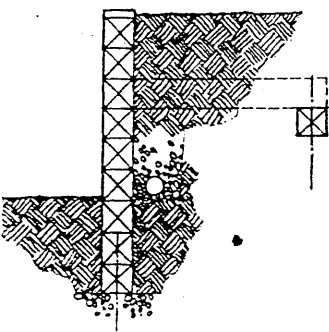
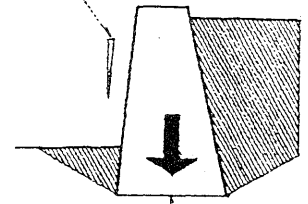
**toe**  
The forward, lower tip of the base of a footing or retaining wall, extended to give broader bearing and greater stability.

**counterfort**  
A triangular-shaped cross wall tying a concrete retaining wall to its base at regular intervals, built on the side of the material to be retained in order to stiffen the vertical slab and add weight to the base.

**cantilever wall**  
A retaining wall of reinforced concrete or reinforced concrete masonry, cantilevered from and securely tied to a spread footing that is shaped to resist overturning and sliding.

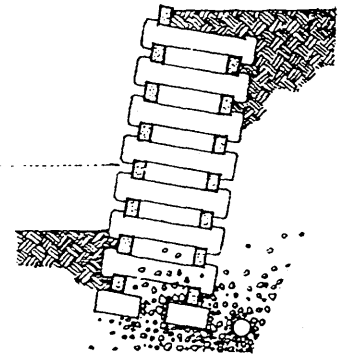


**batter**  
A backward slope of the face of a wall as it rises.



**deadman**  
A log, concrete block, or similar mass buried in the ground as an anchor.

**gravity wall**  
A masonry or concrete retaining wall that resists overturning and sliding by the sheer weight and volume of its mass.



**bin wall**  
A type of gravity retaining wall formed by stacking modular, interlocking precast concrete units and filling the voids with crushed stone or gravel. Also called cellular wall.

**cribbing**  
A system of cribs for retaining earth or for a building being moved or having its foundation rebuilt. Also called cribwork.

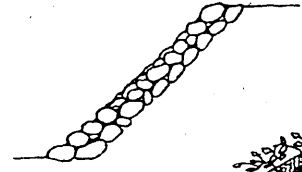
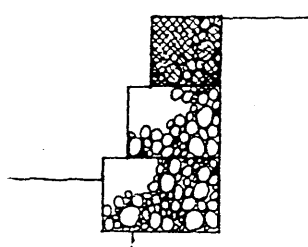


**earth tieback wall**  
A retaining wall consisting of precast concrete panels fastened to long galvanized steel straps extending into a compacted soil backfill.

**crib**  
A cellular framework of squared timbers, or steel or concrete members of similar form, assembled in layers at right angles, often filled with earth or stones and used in the construction of foundations and retaining walls.

**riprap**  
A layer of broken stones thrown together irregularly on an embankment slope to prevent erosion.

**critical height**  
The maximum height at which a vertical cut in a cohesive soil will stand without shoring.



**angle of repose**  
The maximum slope, measured in degrees from the horizontal, at which loose solid material will remain in place without sliding.

**angle of slide**  
The minimum slope, measured in degrees from the horizontal, at which loose solid material will begin to slide or flow.

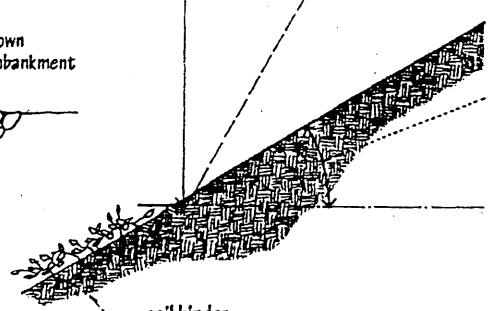
**gabion**  
Galvanized wire basket filled with stones and used in constructing an embankment or retaining structure.

**revet**  
To face a sloping surface or embankment with stone or other material.

**soil binder**  
A plant that prevents or inhibits erosion by providing a ground cover and forming a dense network of roots that hold the soil.

**soil stabilizer**  
A chemical admixture for maintaining or increasing the stability of a soil mass.

**revetment**  
A facing of masonry or other suitable material for protecting an embankment against erosion.



**window unit**

A manufactured assembly of a frame, sash, glazing, and necessary hardware, made to fit a window opening.

**sash**

The fixed or movable framework of a window or door in which panes of glass are set.

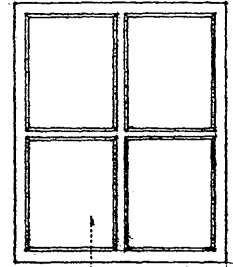
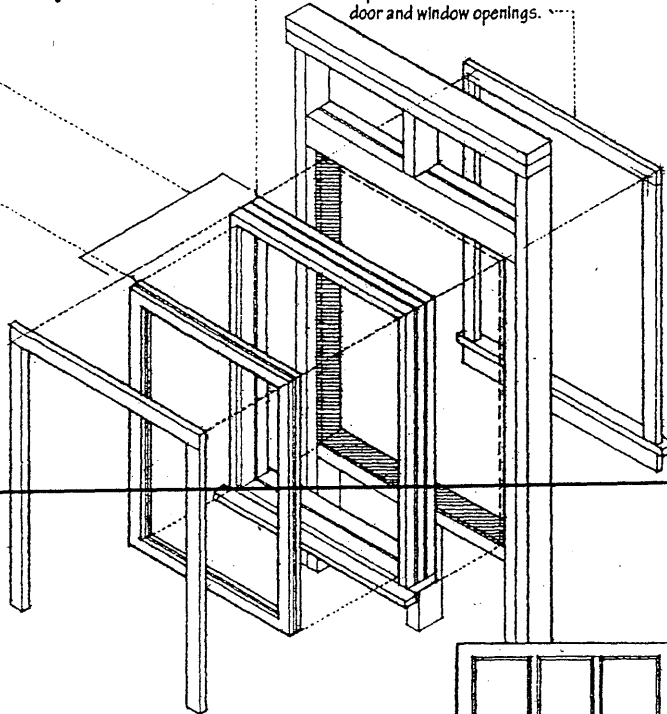
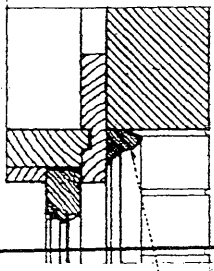
**window frame**

The fixed frame of a window, consisting of two jambs, a head, and a sill.

**dressing**

The ornamental detail of a building, esp. the molded framework around door and window openings.

An opening in the wall of a building for admitting light and air, usually fitted with a frame in which are set operable sashes containing panes of glass.



**pane**

One of the divisions of a window or door, consisting of a single unit of glass set in a frame.

**windowpane**

A pane of glass fitting a window sash.

**brick molding**

A wood molding covering the gap between a doorframe or window frame and the masonry reveal into which the frame is set. Also called staff bead.

**head flashing**

The flashing over a window opening or a projection in a masonry wall.

**drip**

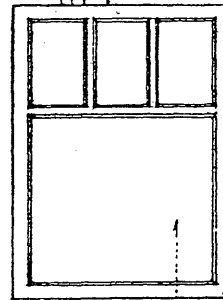
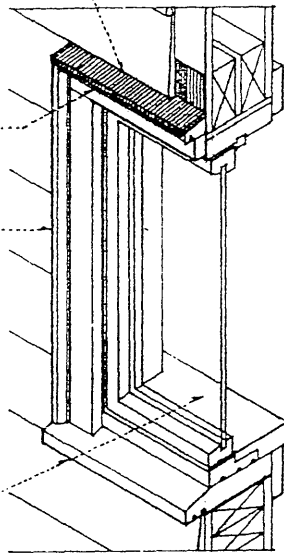
Any of various devices for shedding rainwater so as to keep it from running down a wall or falling onto the sill of an opening.

**drip cap**

A projecting molding over an exterior door or window opening for catching and shedding rainwater.

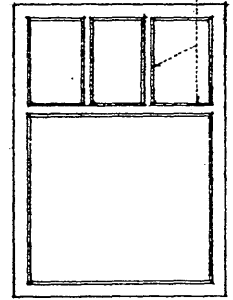
**backband**

A molding surrounding the trim at the top and sides of a door or window.



**muntin**

A rabbeted member for holding the edges of windowpanes within a sash. Also called glazing bar, sash bar.



**mullion**

A vertical member between the lights of a window.

**light**

A medium for admitting light, as one compartment of a window or window sash. Also called day.

**windowsill**

The horizontal member at the base of a window opening, esp. the ledge formed by such a member.

**wash**

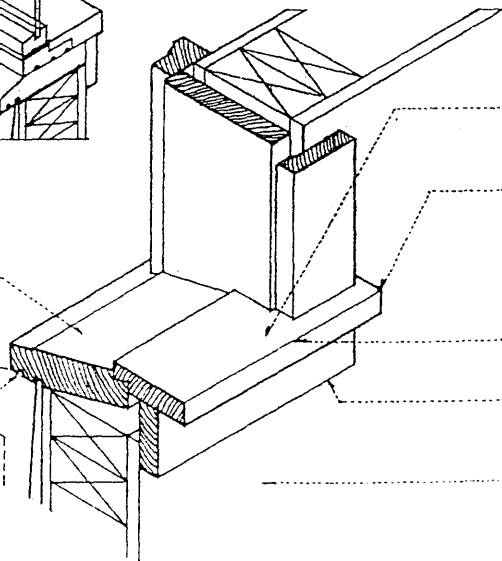
The upper surface of a building member, as a windowsill or coping, sloped to shed rainwater. Also called weathering.

**check throat**

A groove cut or formed on the underside of a sill or other exterior horizontal member to prevent the capillary flow of rainwater to a wall.

**subsill**

An additional sill fitted to a window frame to cause rainwater to drip farther away from a wall surface. Also called sill drip molding.



**slip sill**

A sill cut to fit between the jambs of a window or door opening.

**lug sill**

A sill extending beyond a window or door opening and built into the jambs.

**horn**

That part of a jamb extending above the head of a door or window frame, or the horizontal extension of a windowsill beyond the jamb.

**stool**

The interior sill of a window.

**apron**

A flat piece of trim immediately beneath the stool of a window. Also called skirt.

**back**

The area of interior wall, usually paneled, between a windowsill and the floor.

# WINDOW

## double-hung window

A window having two vertically sliding sashes, each in separate grooves or tracks and closing a different part of the window.

## hung sash

A vertically sliding window sash balanced by a counterweight or a pretensioned spring on each side so that it can be raised or lowered with relatively little effort. Also called *balanced sash*.

## meeting rail

The rail of each sash in a double-hung window that meets at the rail of the other when the window is closed.

## sash fast

A fastener on the meeting rail of one sash which swings across to the meeting rail of another sash and engages with a spur on it. Also called *sash fastener*.

## check rail

A meeting rail, esp. one closing against a corresponding rail with a diagonal or rabbeted overlap.

## plain rail

A meeting rail equal in thickness to the other members of the frame.

## box-head window

A double-hung window constructed with a pocket in the head, into which one or both sashes can pass to increase the opening available for ventilation.

## drop window

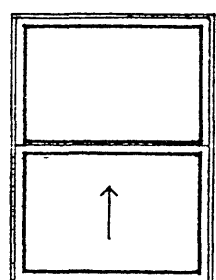
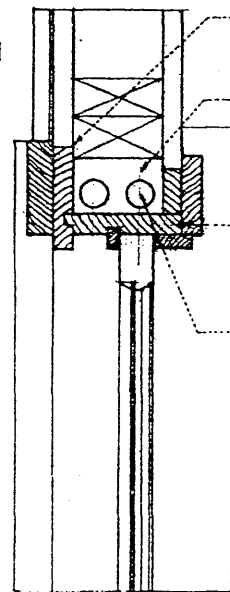
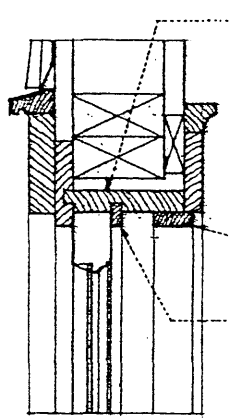
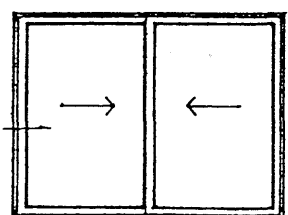
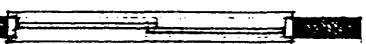
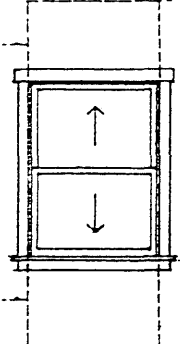
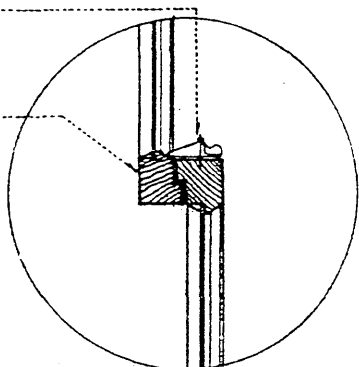
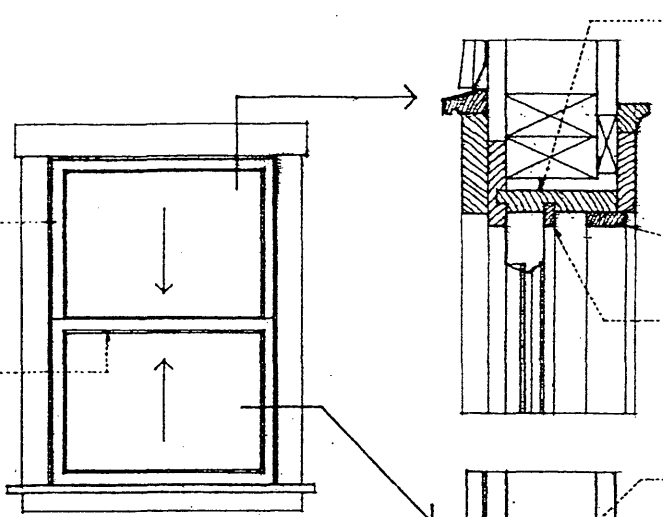
A window constructed with a pocket below the sill, into which a sash can slide to increase the opening available for ventilation.

## horizontally sliding window

A window having two or more sashes, of which at least one slides along horizontal grooves or tracks.

## sliding sash

A sash that opens by moving horizontally along grooves or tracks at the top and bottom of the window frame.



## yoke

A horizontal piece forming the top of a frame for a double-hung window.

## stop

A strip of molding along the inside of window frame for holding a sliding sash, or against which a sash closes. Also called *sash stop*, *window stop*.

## stop bead

A strip of molding along the inside of a window frame for holding a sliding sash.

## parting bead

A strip of molding used on each side of a frame of a double-hung window to keep the upper and lower sashes apart when raised or lowered. Also called *parting strip*.

## blind casing

The rough casing of a box frame to which trim is secured.

## box frame

A window frame having hollow jambs or mullions for sash weights.

## hanging stile

A stile in a window frame against which a window sash slides. Also called *pulley stile*.

## sash weight

A cylindrical casing of iron or lead used as a counterweight to balance a vertically sliding window sash.

## sash line

A rope (*sash cord*) or chain (*sash chain*) for connecting a vertically sliding window sash with a counterweight.

## sash ribbon

A strip of steel or aluminum alloy used in place of a sash cord to connect a vertically sliding window sash with a counterweight.

## pocket piece

A removable part of a hanging stile permitting access to insert a sash weight or to replace the sash line.

## single-hung window

A window having two sashes, of which only one is movable.

## vertically sliding window

A window having one or more sashes which move vertically and are held in various open positions by means of friction or a ratchet device instead of by sash balances or counterweights.

## sash balance

A spring-loaded device used in place of sash weights to counterbalance a vertically sliding window sash. Also called *spring balance*.

**extension casement hinge**

A hinge for an outward-swinging casement window, located to allow cleaning from the inside when the window is open.

**casement stay**

A bar for holding a casement in any of several open positions.

**lever operator**

A gearless device for operating a casement and holding it in an open position.

**cam handle**

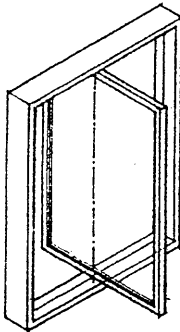
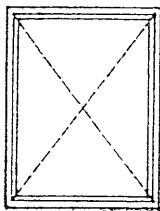
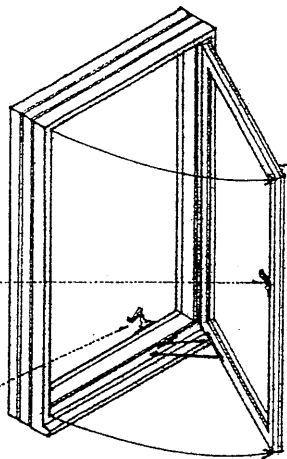
A handle that locks a hinged sash in a closed position by wedging it against a keeper plate. Also called locking handle.

**roto operator**

A crank-driven worm drive for opening and closing awning windows, casement windows, and jalousies.

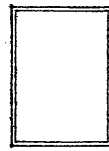
**wicket screen**

A small sliding or hinged portion of a larger screen providing access for operating a window sash.



**pivoted window**

A window having a sash that rotates 90° or 180° about a vertical or horizontal axis at or near its center, used in air-conditioned multistory or high-rise buildings and operated only for cleaning, maintenance, or emergency ventilation.



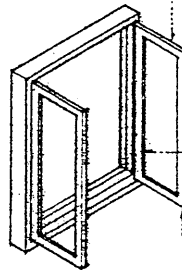
**fixed light**

A window or sash of a window that does not open for ventilation. Also called fixed sash.



**operable window**

A window having a sash that may be opened for ventilation.



**casement window**

A window with at least one casement, often used in combination with fixed lights.

**casement**

A window sash opening on hinges generally attached to the upright side of its frame.

**folding casement**

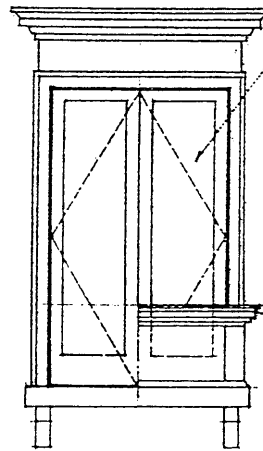
A pair of casements with rabbeted meeting stiles, hung in a frame having no mullion.

**hanging stile**

The stile of a window frame from which a casement is hung.

**meeting stile**

One of the abutting stiles in a pair of casement.



**French window**

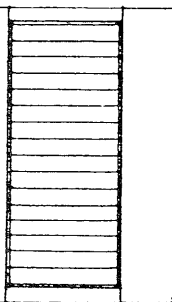
A pair of casement windows extending to the floor and serving as a doorway, esp. from a room to an outside porch or terrace.

**cremorne bolt**

A vertical bolt used on a French window or the like, consisting of two rods moved by a knob mechanism and extending into pockets in the head and sill of the opening to provide a secure fastening. Also, cremone bolt.

**balconet**

A railing or balustrade projecting slightly beyond the plane of a window and reaching to the floor, having the appearance of a balcony when the window is fully open. Also, balconette.



**jalousie window**

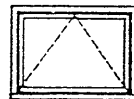
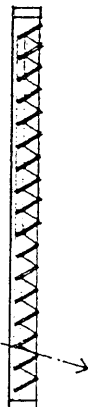
A window having horizontal glass or wood louvers which pivot simultaneously in a common frame, used primarily in mild climates to control ventilation and to cut off visibility from the outside.

**jalousie**

A blind or shutter having horizontal slats that can be adjusted to admit light and air but exclude sun and rain.

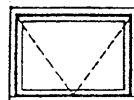
**shielding angle**

The angle below which something can be seen when viewed through a louver.



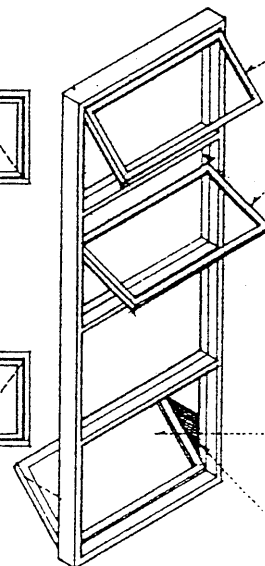
**awning window**

A window having one or more sashes swinging outward on hinges generally attached to the top of the frame.



**projected window**

A casement or awning window in which the inner end of the sash slides along a track on the sill or jamb as the sash swings outward.



**hopper window**

A window having one or more sashes swinging inward on hinges generally attached on the bottom. Also called hospital window.

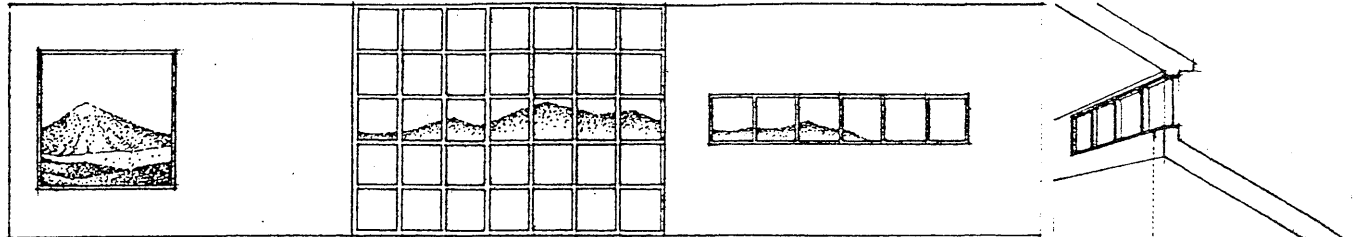
**hopper light**

A window light hinged on the bottom and swinging inward. Also called hospital light.

**hopper**

One of the triangular draft barriers on each side of a hopper light.

# WINDOW



**picture window**  
A large, usually fixed single-pane window, placed to frame an attractive exterior view.

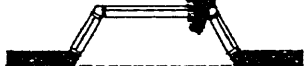
**window wall**  
A nonbearing wall composed primarily of vertical and horizontal framing members containing a combination of fixed lights and operating sashes.

**ribbon window**  
A horizontal band of windows, separated only by mullions.

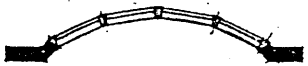
**clerestory**  
A portion of an interior rising above adjacent rooftops and having windows admitting daylight to the interior. Also, clerestory.

**bay window**  
A window or series of windows projecting outward from the main wall of a building and forming a bay or alcove in a room within, esp. one having its own foundation.

**window seat**  
A seat built into a recess of a window between the jambs.



**cant bay window**  
A bay window having canted sides.



**bow window**  
A bay window having a rounded projection.

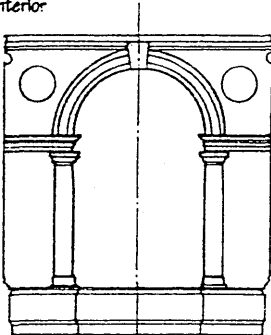
**dormer window**  
A vertical window in a projection built out from a sloping roof. Also called luthern.

**internal dormer**  
A vertical window set below the line of a sloped roof.

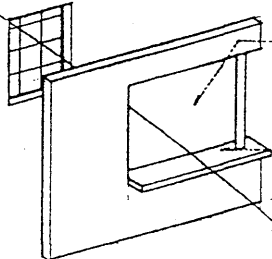
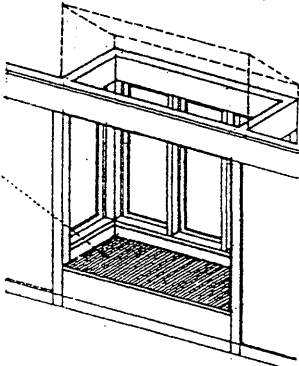
**lucarne**  
A dormer window in a roof or spire.

**oxeye**  
A comparatively small round or oval window, as in a frieze or dormer. Also called oeil-de-boeuf.

**hood mold**  
A projecting molding over the arch of a window or door, esp. in interior work. Also, hood molding.

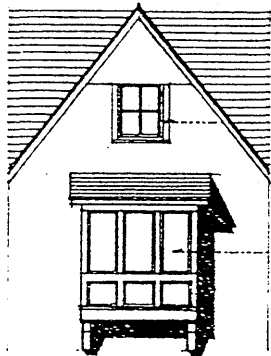


**Palladian motif**  
A window or doorway in the form of a round-headed archway flanked on either side by narrower compartments, the side compartments being capped with entablatures on which the arch of the central compartment rests. Also called Serlian motif, Venetian motif.



**borrowed light**  
A window opening in an interior partition allowing light to be transmitted from one space to another.

**pass-through**  
A windowlike opening in a wall or partition through which things may be passed, as between a kitchen and a dining room.



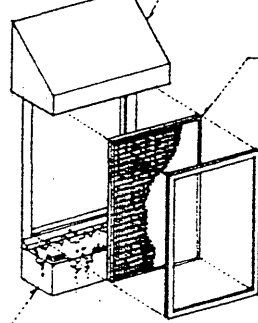
**gable window**  
A window in or under a gable.

**oriel**  
A bay window supported from below by corbels or brackets.

**meshrebeeyeh**  
An oriel screened by latticework, through which the air may draw freely while the interior is concealed from view, found along the streets of Cairo and other towns of the Levant. Also, mashrebeeyeh, mashrebeeyah.

**lychnoscope**  
A small window set low in the wall of a medieval church, permitting the interior to be seen from the outside. Also called lowside window.

**awning**  
A rooflike cover of canvas or other material extending in front of a doorway or window, or over a deck, to provide protection from the sun or rain.



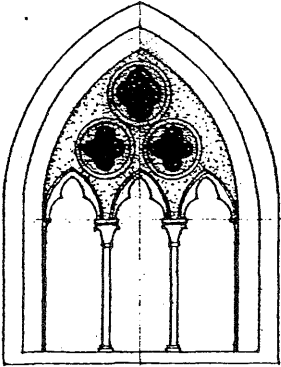
**screen**  
A frame holding a fine mesh of metal or fiberglass, placed in a window or doorway, or around a porch to admit air but exclude insects.

**storm window**  
A supplementary sash placed outside an existing window as additional protection against severe weather. Also called storm sash.

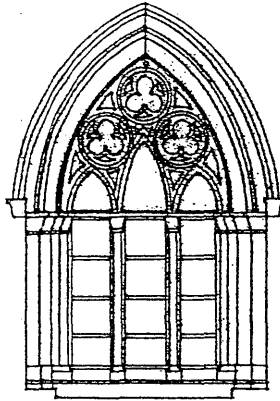
**combination window**  
A window equipped with interchangeable screen and glass sections for summer and winter use.

**window box**  
A box designed to hold soil for growing plants at or on a windowsill.

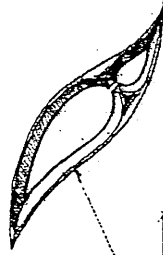
**tracery**  
Ornamental work of branchlike lines, esp. the lacy openwork in the upper part of a Gothic window.



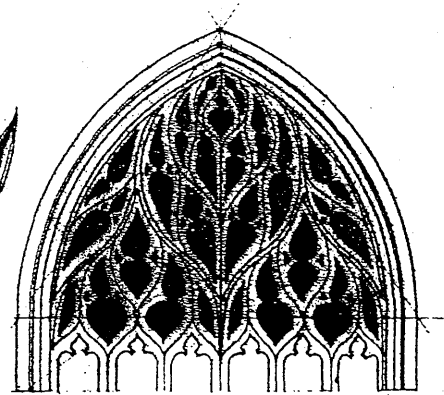
**plate tracery**  
Early Gothic tracery formed of pierced slabs of stone set on edge, the design being in the shape and disposition of the openings. Also called perforated tracery.



**geometric tracery**  
Gothic tracery characterized by a pattern of geometric shapes, as circles and foils.

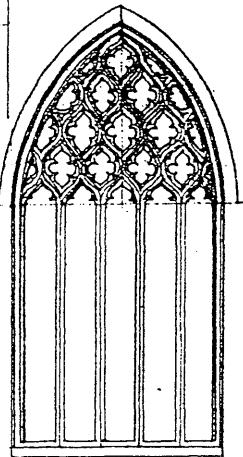


**mouchette**  
A daggerlike motif found esp. in Gothic tracery, formed by elliptical and ogee curves.



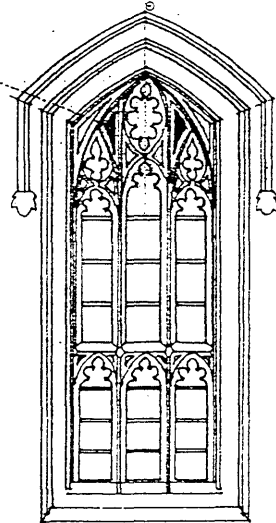
**curvilinear tracery**  
Gothic tracery characterized by a pattern of irregular, boldly curved forms. Also called flowing tracery.

**bar tracery**  
Gothic tracery that succeeded plate tracery, consisting of molded stone mullions that divide into various branching elements which fill the window head.



**reticulated tracery**  
Gothic tracery consisting mainly of a netlike arrangement of repeated geometrical figures. Also called net tracery.

**angel light**  
A triangular light in a Gothic window, formed by the arch of the window, an arch of a lower tier of tracery, and a mullion of an upper tier of tracery.



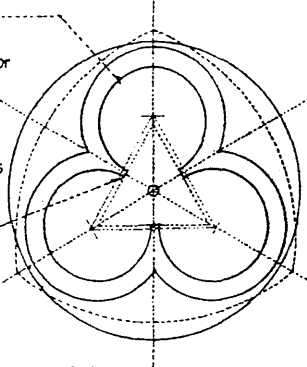
**perpendicular tracery**  
Predominantly vertical Gothic tracery having mullions rising to the curve of the arch, crossed at intervals by horizontal transoms. Also called rectilinear tracery.

**foil**  
Any of several arcs or rounded spaces divided by cusps and tangent to the interior of a larger arc, as of an arch or circle.

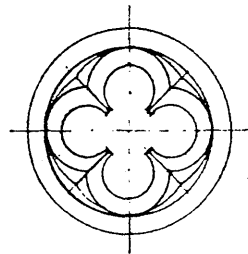
**foliation**  
Ornamentation of an archway, window, or other opening with foils or representations of foliage.

**cusps**  
A pointed projection formed by two intersecting arcs, used esp. to vary the outlines of intradoses or to form foils.

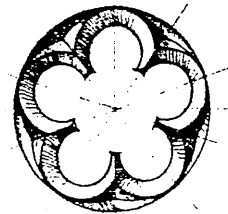
**cuspidation**  
Decoration with cusps.



**trefoil**  
An arrangement of three foils divided by cusps and radiating from a common center.



**quatrefoil**  
An ornament composed of four foils, divided by cusps and radiating from a common center.

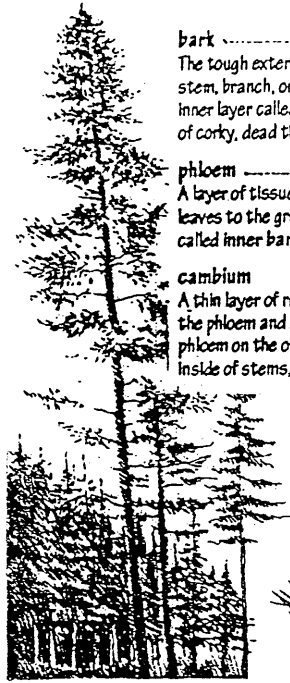


**cinquefoil**  
A design composed of five foils, divided by cusps and radiating from a common center.

**multifoil**  
Having more than five foils.

# WOOD

The tough, fibrous cellular substance that makes up most of the stems and branches of trees beneath the bark.



**bark**  
The tough external covering of a woody stem, branch, or root, composed of a living inner layer called phloem and an outer bark of corky, dead tissue.

**phloem**  
A layer of tissue that carries food from the leaves to the growing parts of a tree. Also called inner bark.

**cambium**  
A thin layer of reproductive tissue between the phloem and xylem, which produces new phloem on the outside and new xylem on the inside of stems, branches, and roots.

**pith**  
The soft, central core about which first growth takes place in a newly formed stem.

**xylem**  
The woody tissue of a tree that provides support and conducts water and mineral nutrients upward from the roots.

**lignin**  
An organic substance that, with cellulose, forms the woody cell walls of plants and the cementing material between them.

**cellulose**  
An inert carbohydrate that is the chief constituent of the cell walls of plants and of dried woods, jute, hemp, and cotton, used in the manufacture of a wide variety of synthetic building materials.

**sapwood**  
The younger, softer, living portion of wood between the cambium and heartwood, comparable in strength to heartwood but usually lighter in color, more permeable, and less durable. Also called albumen.

**heartwood**  
The older, harder, inactive core of a tree, usually darker, denser, and more durable than the surrounding sapwood. Also called duramen.

**annual ring**  
A concentric layer of wood produced during a single year's growth of a temperate tree. Also called growth ring.

**springwood**  
The softer, more porous portion of an annual ring that develops early in the growing season, characterized by large, thin-walled cells. Also called early wood.

**summerwood**  
The harder, darker, less porous portion of an annual ring that develops late in the growing season, characterized by compact, thick-walled cells. Also called late wood.

**softwood**  
The wood from a conifer. The term is not descriptive of the actual softness of the wood.

**conifer**  
Any of various predominantly evergreen, cone-bearing trees, as pine, fir, hemlock, and spruce.

**evergreen**  
Having foliage that remains green and functional throughout the year or through more than one growing season.

**crown**  
The leaves and living branches of a tree.

**trunk**  
The main stem of a tree apart from its branches and roots.

**resin duct**  
A tubular, intercellular space in a woody stem that secretes resins, esp. in conifers. Also called resin canal.

**resin**  
A viscous, clear to translucent, organic substance exuded by certain pines, used in making varnishes, adhesives, and plastics.

**pitch**  
The resinous sap that exudes from various conifers.

**tracheid**  
One of the elongated, supporting and conductive cells in woody tissue, having tapering closed ends and lignified walls oriented parallel to the axis of a stem or branch.

**vessel**  
A tubular structure of woody tissue for conducting water and mineral nutrients, formed by the fusion and loss of end walls in a series of connected cells.

**ray**  
One of the vertical bands of transverse cells that radiate between pith and bark for the storage and horizontal conduction of nutrients.

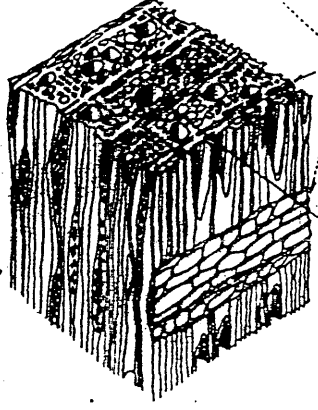
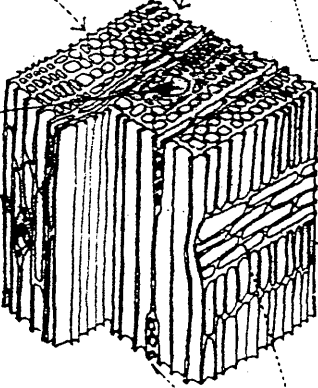
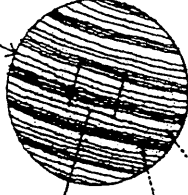
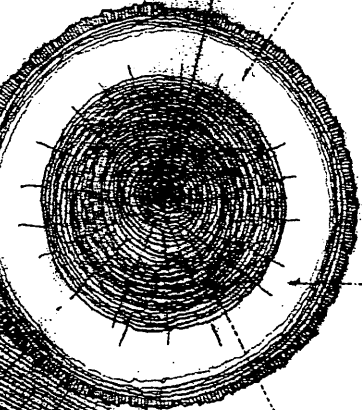
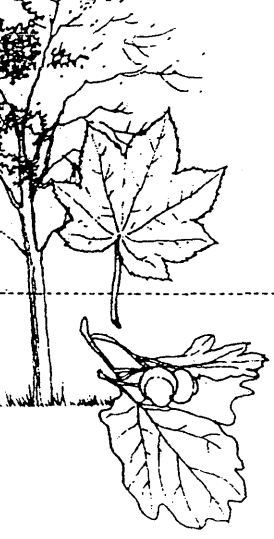
**pore**  
One of the relatively large vertical cells for conducting sap, esp. in hardwood trees.

**sap**  
The vital fluid of water, nitrogen, and mineral nutrients that circulates through a plant.

**fiber**  
One of the slender, thick-walled cells which together serve to strengthen plant tissue.

**hardwood**  
The wood from a broad-leaved flowering tree, as cherry, maple, or oak. The term is not descriptive of the actual hardness of the wood.

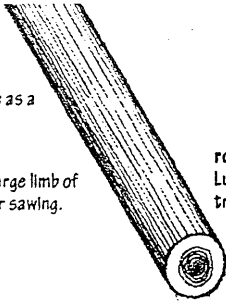
**deciduous**  
Shedding leaves annually or at the end of a growing season. The term is descriptive of most hardwoods and a few softwoods.



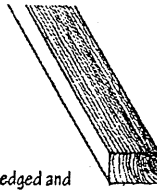


**timber**  
Wood suitable for use as a building material.

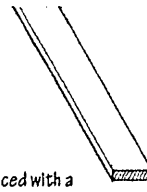
**log**  
A length of trunk or large limb of a felled tree, ready for sawing.



**rough lumber**  
Lumber that is sawn, edged and trimmed, but not surfaced.



**dressed lumber**  
Lumber that is surfaced with a planing machine to attain a smooth surface and uniform size.



**lumber**  
The timber product manufactured by sawing, resawing, passing lengthwise through a planing machine, cross-cutting to length, and grading.

**seasoned**  
Of or pertaining to lumber that has been dried to reduce its moisture content and improve its serviceability.

**kiln-dried**  
Of or pertaining to lumber seasoned in a kiln under controlled conditions of heat, air circulation, and humidity.

**air-dried**  
Of or pertaining to lumber seasoned by exposure to the atmosphere.

**surfaced green**  
Of or pertaining to dressed lumber having a moisture content exceeding 19% at the time of manufacture.

**surfaced dry**  
Of or pertaining to dressed lumber having at a moisture content of 19% or less at the time of manufacture.

**oven-dry**  
Of or pertaining to lumber dried to a point at which no moisture can be extracted when exposed in a kiln to a temperature of 214° to 221°F (101° to 105°C).

**equilibrium moisture content**  
The moisture content at which wood neither gains nor loses moisture when surrounded by air at a given temperature and relative humidity.

**fiber-saturation point**  
The stage in the drying or wetting of wood at which the cell walls are fully saturated but the cell cavities are void of water, ranging from a moisture content of 25% to 32% for commonly used species. Further drying results in shrinkage and generally greater strength, stiffness, and density of the wood.

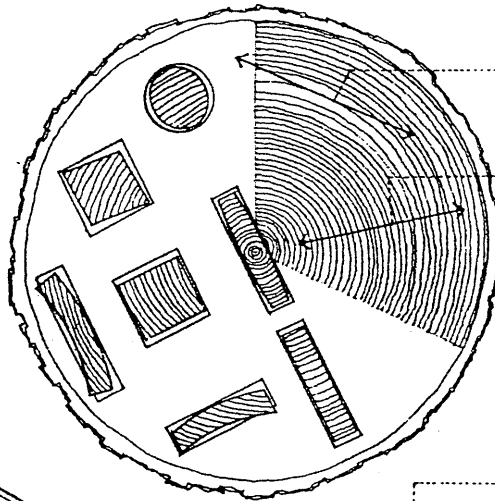
**moisture content**  
The amount of water contained in a wood piece, expressed as a percentage of the weight of the wood when oven-dry.



**shrinkage**  
The dimensional contraction of a wood piece occurring when its moisture content falls below the fiber-saturation point. Shrinkage is very slight along the grain, but significant across the grain.

**working**  
The alternate swelling and shrinkage of seasoned wood occurring with changes in moisture content caused by changes in relative humidity of the surrounding air.

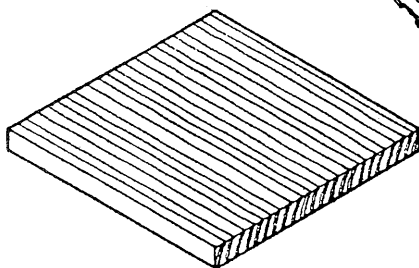
**acclimatize**  
To store wood products, as millwork and flooring, in an interior space until the materials adapt to the moisture content and temperature of the new environment.



**tangential shrinkage**  
Wood shrinkage in a direction tangent to the growth rings, about double that of radial shrinkage.

**radial shrinkage**  
Wood shrinkage perpendicular to the grain, across the growth rings.

**longitudinal shrinkage**  
Wood shrinkage parallel to the grain, about 2% of radial shrinkage.

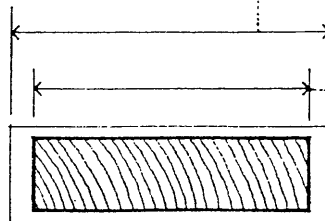


**board foot**  
A unit of quantity for lumber equal to the volume of a piece whose nominal dimensions are 12 in. (304.8 mm) square and 1 in. (25.4 mm) thick.

**board measure**  
Lumber measurement in board feet.

**nominal dimension**  
The dimension of lumber before drying and surfacing, used for convenience in defining size and computing quantity. Nominal dimensions are always written without inch marks. Also called nominal size.

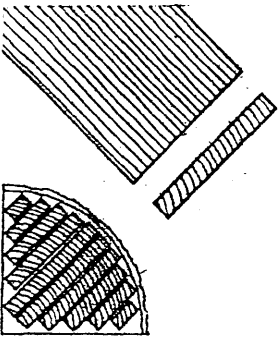
**dressed size**  
The dimension of lumber after seasoning and surfacing, from 3/8 to 3/4 in. (9.5 to 19.1 mm) less than the nominal dimension. A dressed size is always written with inch marks ("). Also called dressed dimension.



# WOOD

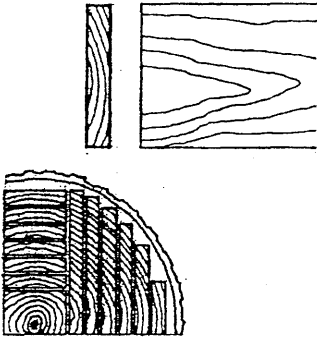
**grain**  
The direction, size, arrangement, and appearance of the fibers in a piece of dressed wood.

**edge grain**  
Wood grain resulting from quartersawing, having the annual rings forming an angle of 45° or more with the broad faces of a piece. Also called **vertical grain**.



**quartersaw**  
To saw quartered logs approximately at right angles to the annual rings.

**flat grain**  
Wood grain resulting from plain-sawing, having the annual rings forming an angle of less than 45° with the broad faces of a piece.



**plain-saw**  
To saw a squared log into boards with evenly spaced parallel cuts. Also called **bastard-saw**.

**warp**  
Any deviation from a plane or true surface of a board or panel, usually caused by uneven drying during the seasoning process or by a change in moisture content.

**cup**  
A curvature across the width or face of a wood piece, measured at the point of greatest deviation from a straight line drawn from edge to edge of the piece.

**bow**  
A curvature along the length of a wood piece, measured at the point of greatest deviation from a straight line drawn from end to end of the piece.

**crook**  
A curvature along the edge of a wood piece, measured at the point of greatest deviation from a straight line drawn from end to end of the piece.

**twist**  
A warp resulting from the turning of the edges of a wood piece in opposite directions.

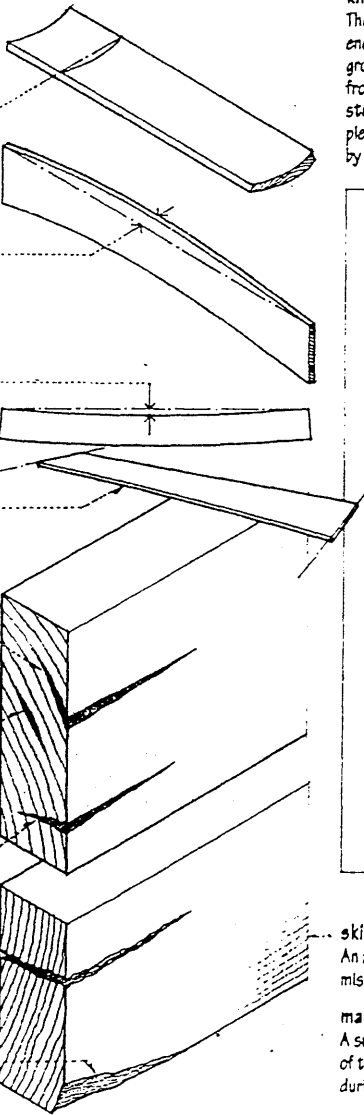
**shake**  
A separation along the grain of a wood piece, usually between the annual rings, caused by stresses on a tree while standing or during felling.

**pitch pocket**  
A well-defined opening between the annual rings of a softwood, containing or having once contained solid or liquid pitch.

**check**  
A lengthwise separation of wood across the annual rings, caused by uneven or rapid shrinkage during the seasoning process.

**split**  
A check that extends completely through a board or wood veneer. Also called **through check**.

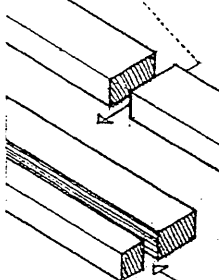
**wane**  
The presence of bark or absence of wood at corner or along an edge of a piece.



**mixed grain**  
Any combination of edge-grained and flat-grained lumber.

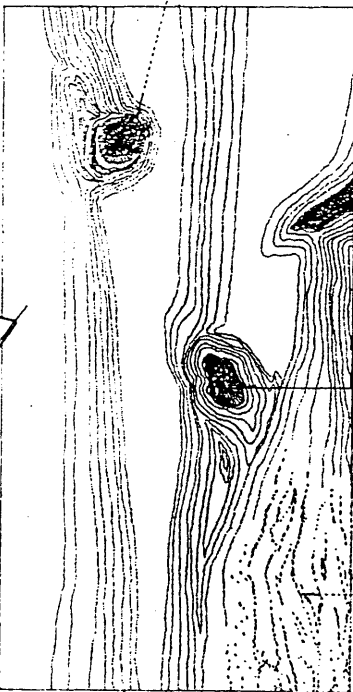
**end grain**  
Wood grain resulting from a cut across the grain.

**crosscut**  
A cut made across the grain of wood.



**rip**  
To saw wood in the direction of the grain. Also called **ripsaw**.

**knot**  
The base of a woody branch enclosed by a subsequent growth of wood in the stem from which it rises. In the structural grading of a wood piece, knots are restricted by size and location.



**skip**  
An area on the surface of a board or panel missed by a planing machine.

**machine burn**  
A surface charring caused by overheating of the cutting blades or abrasive belts during shaping or finishing of a material.

**diagonal grain**  
Wood grain having the annual rings at an angle to the length of a piece, resulting from sawing at an angle to the axis of a log.

**cross grain**  
Wood grain having the cells and fibers running transversely or diagonally to the length of a piece as a result of sawing, or irregularly as a result of a growth characteristic.

**close grain**  
Wood grain characterized by narrow, inconspicuous annual rings with little difference in pore size between springwood and summer wood.

**coarse grain**  
Wood grain characterized by wide, conspicuous annual rings with considerable contrast in pore size between springwood and summer wood.

**coarse texture**  
Wood grain having large pores. Also called **open grain**.

**fine texture**  
Wood grain having small, closely spaced pores.

**raised grain**  
A dressed wood surface having the denser summerwood rising above the softer springwood.

**live knot**  
A knot having annual rings intergrown with those of the surrounding wood. Live knots are allowable in structural timber within certain size limits. Also called **intergrown knot**.

**sound knot**  
A knot that is solid across its face, at least as hard as the surrounding wood and undecayed.

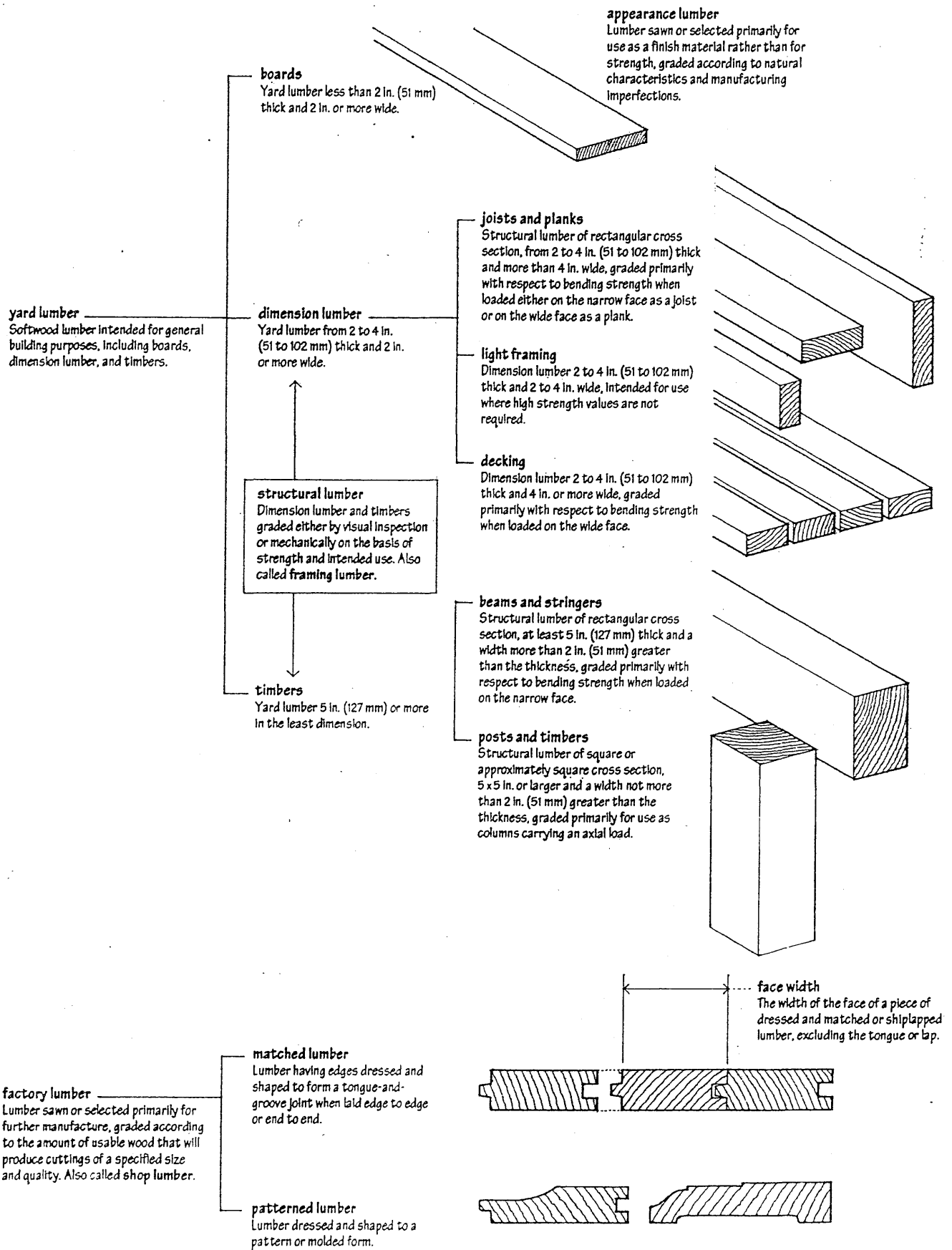
**tight knot**  
A knot held firmly in place by growth or position.

**dead knot**  
A knot having annual rings not intergrown with those of the surrounding wood. Encasement may be partial or complete, but a dead knot is considered to be a defect since it can easily loosen or be knocked out. Also called **encased knot**, **loose knot**.

**decay**  
The decomposition of wood by fungi and other microorganisms, resulting in softening, loss of strength and weight, and often a change of texture and color.

**dry rot**  
A decay of seasoned timber caused by fungi that consume the cellulose leaving a soft, brittle skeleton readily reduced to powder.

**pecky**  
Having isolated spots of incipient decay from fungi, as pecky cypress or pecky cedar.



# WOOD

## visual grading

The visual examination and grading of structural lumber by trained inspectors according to quality-reducing characteristics that affect strength, appearance, durability, or utility.

## machine rating

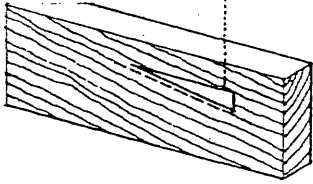
The grading of structural lumber by a machine that flexes a test specimen, measures its resistance to bending, calculates its modulus of elasticity, and electronically computes the appropriate stress grade, taking into account such factors as the effects of knots, slope of grain, growth rate, density, and moisture content. Also called machine stress-rating.

## grademark

A stamp applied to each piece of lumber indicating the assigned stress grade, mill of origin, moisture content at time of manufacture, species or species group, and the grading authority.

## slope of grain

The angle of grain relative to a line parallel to the length of a wood piece.

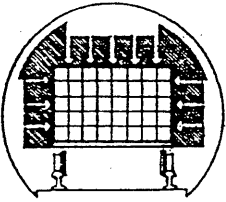


## treated wood

Wood that has been coated or impregnated with chemicals to improve its resistance to decay, insect infestation, or fire.

## pressure-treated wood

Wood impregnated with chemicals applied under pressure to reduce its resistance to decay and insect infestation.



## non-pressure-treated wood

Wood coated, dipped, or impregnated with a preservative under atmospheric pressure.

## fire-retardant wood

Wood treated with mineral salts impregnated under pressure to reduce flammability or combustibility. The salts react chemically at temperatures below the ignition point of wood, causing the combustible vapors normally generated in the wood to break down into water and carbon dioxide.

## stress grade

Any of the grades of structural lumber for which a set of base values and corresponding modulus of elasticity is established for a species or group of species by a grading agency.

## design value

Any of the allowable unit stresses for a species and grade of structural lumber obtained by modifying the base value by factors related to size and conditions of use.

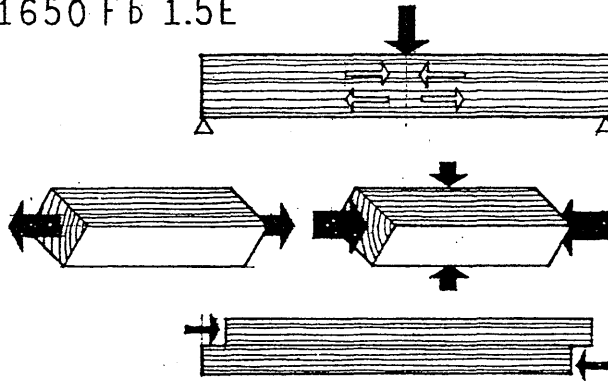
## size-adjusted value

A base value for a species or group of species of structural lumber, adjusted for cross-sectional size.

## base value

Any of the allowable unit stresses for bending, compression perpendicular and parallel to grain, tension parallel to grain, horizontal shear, and corresponding modulus of elasticity, established by a grading agency for various species and grades of structural lumber. Base values must be adjusted first for size and then for conditions of use.

## MACHINE RATED



## full-cell process

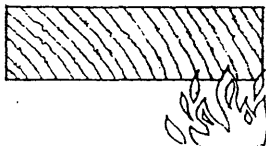
A process for pressure-treating wood in which a vacuum is first drawn to remove air from the wood fibers and allow the preservative to be absorbed by the cell walls, after which pressure is applied to force additional preservative into the cell cavities. The full-cell process leaves the maximum amount of preservative in the wood.

## empty-cell process

A process for pressure-treating wood in which the pressure of the entering preservative entraps air in the wood fibers, which expands when the pressure is released to expel excess preservative from the cell cavities. The empty-cell process yields a drier product while ensuring deep, uniform penetration of the preservative.

## vacuum process

A non-pressure treatment in which a vacuum or partial vacuum exhausts air from the cells and pores of the wood while atmospheric pressure forces preservative into the wood.



## preservative

Any of various substances for coating or impregnating wood in order to protect it against wood-destroying fungi and insects.



## size factor

A coefficient for modifying the base values of a species and grade of lumber according to the cross-sectional size of the piece.

## repetitive member factor

A coefficient for increasing the size-adjusted values of repetitive members, since the sharing of the load by the pieces enhances the strength of the entire assembly.

## repetitive member

Any of a series of three or more light framing members, as joists or rafters, spaced not more than 24 in. (610 mm) on center and joined by sheathing, decking, or other load-distributing members.

## duration of load factor

A coefficient for increasing the size-adjusted values of a wood member subject to a short-term load, since wood has the property of carrying substantially greater maximum loads for short durations than for long durations of loading.

## horizontal shear factor

A coefficient for increasing the size-adjusted horizontal shear value of a wood member having shakes, checks, or splits when their length is known and any increase in length is not anticipated.

## flat use factor

A coefficient for increasing the size-adjusted bending value for planking having a face width of 4 in. (102 mm) or more.

## wet use factor

A coefficient for decreasing the size-adjusted values for wood members when their moisture content will likely exceed 19% in use.

## water-borne preservative

An inorganic, water-soluble compound, as ammoniacal copper arsenite (ACA) or chromated copper arsenite (CCA), used as a wood preservative. ACA and CCA affix chemically to the wood cell walls and is resistant to leaching. The copper acts as a fungicide while the arsenate is toxic to wood-destroying insects. Wood treated with ACA and CCA is odorless and paintable.

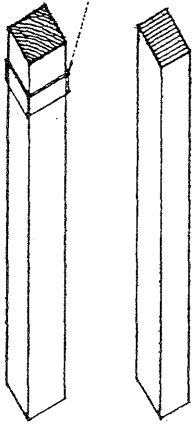
## oil-borne preservative

An organic chemical dissolved in a petroleum oil carrier, as pentachlorophenol or copper naphthenate, used as a wood preservative. Pentachlorophenol, the most commonly used oil-borne preservative, has a persistent odor, is insoluble in water, and is highly toxic not only to fungi and insects but also to humans and plants.

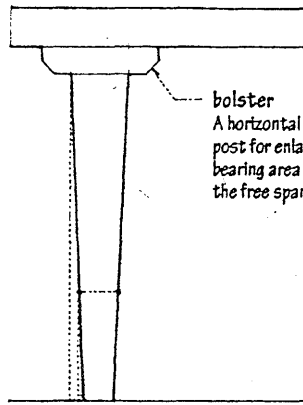
## creosote

An oily liquid of aromatic hydrocarbons obtained by the distillation of coal tar, used as a wood preservative for marine installations or for severe exposures to wood-destroying fungi and insects. Creosote and creosote solutions have a penetrating odor and render wood unpaintable.

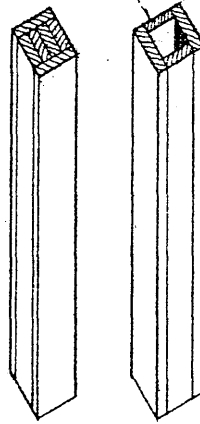
**ferrule**  
A metal ring or cap placed around the end of a wooden post or handle to prevent splitting.



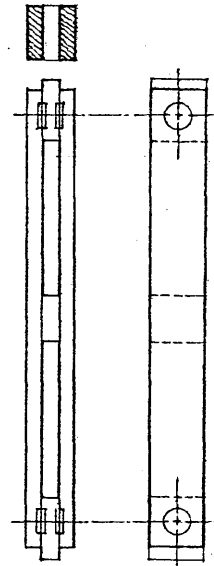
**bracket load**  
An eccentric load applied at some point below the upper end of a timber column, the static effect of which is assumed to be equivalent to the same load applied axially plus an additional side load applied at midheight.



**box column**  
A built-up column having a hollow, square or rectangular cross section.



**bolster**  
A horizontal timber on a post for enlarging the bearing area and reducing the free span of a beam.

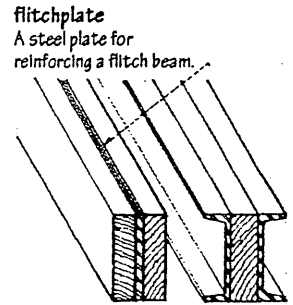
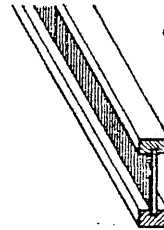
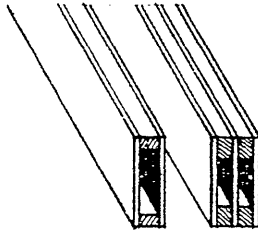
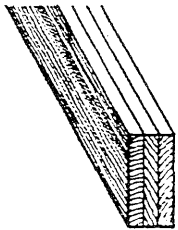


**solid column**  
A wood column consisting of a single piece of solid-sawn or glued-laminated timber, usually square or rectangular in cross section.

**tapered column**  
A wood column having a cross section that diminishes along its length. In determining the slenderness ratio for a tapered column, the least dimension is taken as the sum of the minimum diameter or least dimension and one-third the difference between the minimum and maximum diameters or lesser and greater dimensions.

**built-up column**  
A wood column formed by fastening or gluing cover plates to two or more parallel planks, or boxing planks around a solid core. A built-up column is never equal in strength to a solid column of comparable material and overall dimensions.

**spaced column**  
A wood column consisting of two or more parallel members separated at their ends and midpoints by blocking, and joined at the ends by timber connectors capable of developing the required shear resistance.

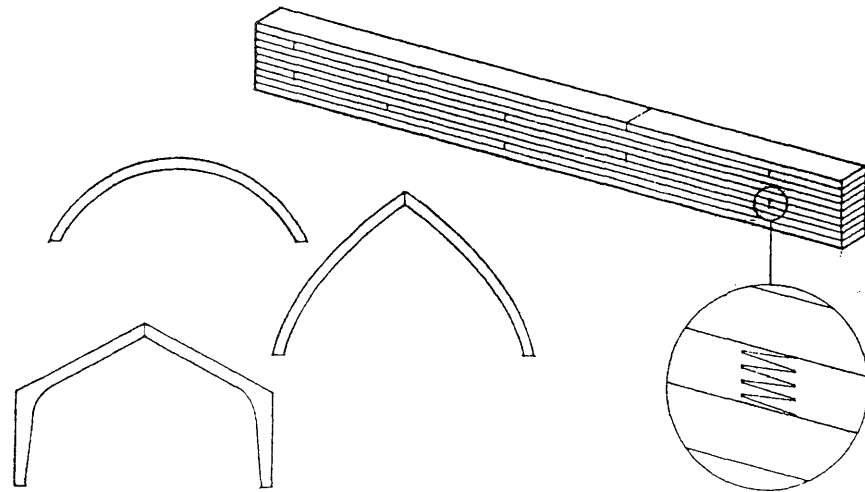


**built-up beam**  
A vertically laminated wood beam made by fastening together two or more smaller members with bolts, lag screws, or spikes, equal in strength to the sum of the strengths of the individual pieces. If none of the laminations are spliced.

**box beam**  
A beam having a hollow, rectangular cross section, made by gluing two or more plywood or oriented strandboard webs to sawn or laminated veneer lumber flanges.

**I-beam**  
A beam made by gluing sawn or laminated veneer lumber flanges along the top and bottom edges of a single plywood or oriented strandboard web. Also called I-joist.

**flitch beam**  
A vertically laminated beam consisting of timbers set on edge and bolted side by side to steel plates or sections. Also called flitch girder, sandwich beam.



**glue-laminated timber**  
A structural lumber product made by laminating stress-grade lumber with adhesive under controlled conditions, usually with the grain of all plies being parallel. The advantages of glue-laminated timber over dimension lumber are generally higher allowable unit stresses, improved appearance, and availability of various sectional shapes. Glue-laminated timbers may be end-joined with scarf or finger joints to any desired length, or edge-glued for greater width or depth. Also called glulam.

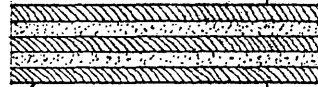
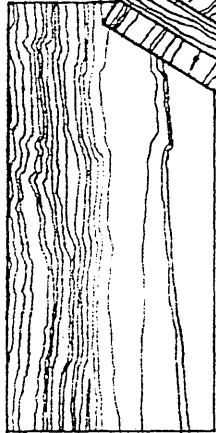
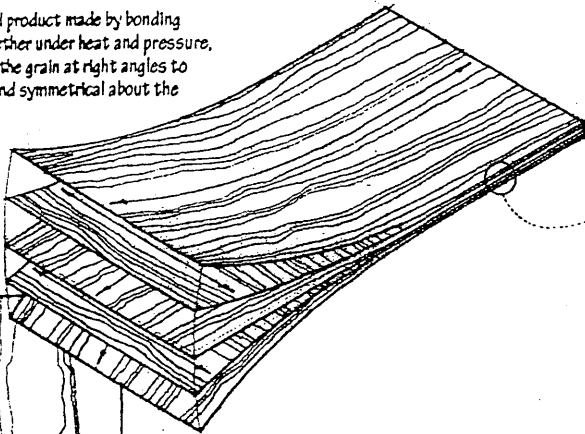
**appearance grade**  
One of three grades of glue-laminated timber – premium, architectural, and industrial – based on surface appearance as affected by growth characteristics, wood fillers, and dressing operations.

examples of glue-laminated timber shapes

# WOOD

## plywood

A wood panel product made by bonding veneers together under heat and pressure, usually with the grain at right angles to each other and symmetrical about the center ply.



### group number

A number identifying one of five groups of species used for the face and back veneers of a plywood panel, the species being classified on the basis of bending strength and stiffness, with Group 1 containing the stiffest species and Group 5 the least stiff.

### span rating

A number specifying the maximum recommended center-to-center spacing in inches of the supports for a structural wood panel spanning with its long dimension across three or more supports.

### exposure durability

A classification of a wood panel product according to its ability to withstand exposure to weather or moisture without weakening or warping.

### exterior

An exposure durability classification for structural wood panels manufactured with a waterproof glue for use as siding or other continuously exposed applications.

### exposure 1

An exposure durability classification for structural wood panels manufactured with an exterior glue for use in protected construction subject to repeated wetting.

### exposure 2

An exposure durability classification for structural wood panels manufactured with an intermediate glue for use in fully protected construction subject to a minimum of wetting.

## exterior plywood

A plywood panel consisting of C-grade veneers or better, bonded with a fully waterproof glue for permanent exposure to weather or moisture.

## interior plywood

A plywood panel made with D-grade veneers or better, bonded with an exterior, intermediate, or interior glue.



### high-density overlay

An exterior wood panel having a resin-fiber overlay on both sides providing a smooth, hard, abrasion-resistant surface, used for concrete forms, cabinets, and countertops. Abbr.: HDO

### medium-density overlay

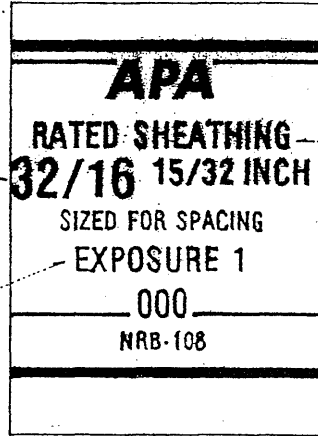
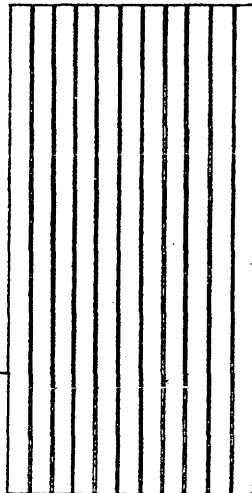
An exterior wood panel having a phenolic or melamine resin overlay on one or both sides providing a smooth base for painting. Abbr.: MDO

### specialty panel

Any of various wood panel products, as grooved or rough-sawn plywood, intended for use as siding or paneling.

### texture 1-11

An exterior plywood panel having grooves 1/4 in. (6.4 mm) deep and 3/8 in. (9.5 mm) wide, spaced 4 or 8 in. (102 or 203 mm) on center.



### panel grade

The grade of a wood panel product identified by the face and back veneer grades or by its intended use.

### engineered grade

The grade of a structural wood panel based on its intended use as sheathing, subflooring, or in the fabrication of box beams and stressed-skin panels.

### gradestamp

A trademark of the American Plywood Association (APA), stamped on the back of a structural wood panel product to identify the panel grade, thickness, span rating, exposure durability classification, mill number, and National Research Board (NRB) report number.

### veneer grade

A grade defining the appearance of a veneer in terms of growth characteristics and the number and size of repairs that may be made during manufacture.

### N-grade

A smooth softwood veneer of all heartwood or all sapwood, free from open defects with only a few well-matched repairs.

### A-grade

A smooth, paintable softwood veneer with a limited number of neatly made repairs parallel to the grain.

### B-grade

A softwood veneer having a solid surface with circular repair plugs, tight knots, and minor splits permitted.

### C-grade

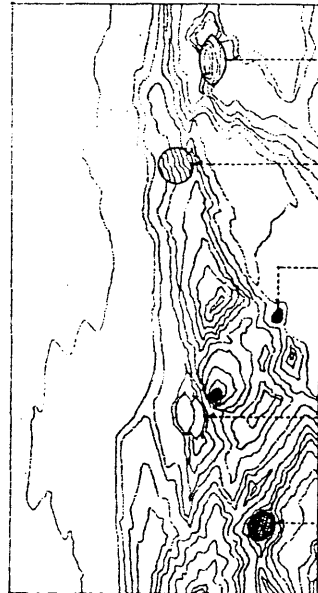
A softwood veneer having tight knots and knotholes of limited size, synthetic or wood repairs, and discoloration and sanding defects that do not impair the strength of the panel.

### C-plugged grade

An improved C-grade softwood veneer having smaller knots and knotholes, some broken grain, and synthetic repairs.

### D-grade

A softwood veneer having large knots and knotholes, pitch pockets, and tapering splits.



**premium grade**

The highest grade of hardwood veneer, permitting only a few small burls, pin knots, and inconspicuous patches.

**good grade**

A grade of hardwood veneer similar to premium grade except that matching of veneer faces is not required.

**sound grade**

A sound, smooth hardwood veneer free of open defects but containing streaks, discoloration, patches, and small sound tight knots.

**utility grade**

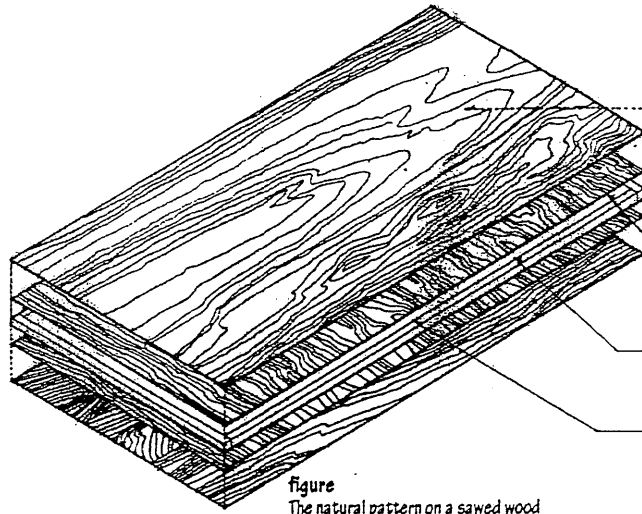
A hardwood veneer permitting discoloration, streaks, patches, tight knots, small knotholes and splits.

**backing grade**

A grade of hardwood veneer similar to utility grade but permitting larger defects not affecting the strength or durability of the panel.

**decorative plywood**

Hardwood-faced plywood manufactured for use as paneling or in cabinetry and furniture.



**veneer**

A thin sheet of wood rotary cut, sliced, or sawn from a log or flitch and used as a superior facing to inferior wood or bonded together to form plywood.

**crossband**

A layer of veneer immediately adjacent to and at right angles to the face plies in a plywood panel.

**core**

The center of a plywood panel, consisting of veneers, sawn lumber, or composition board.

**banding**

The solid wood stock extending around the sides of a veneered panel, concealing the core and facilitating the shaping of the panel edges.

**figure**

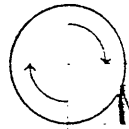
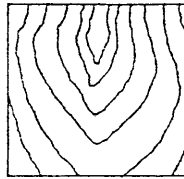
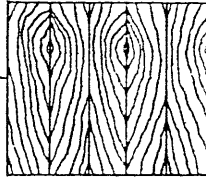
The natural pattern on a sawed wood surface produced by the intersection of annual rings, knots, burls, rays, and other growth characteristics.

**matching**

Arranging sheets of veneers so as to emphasize the color and figure of the wood.

**book matching**

Arranging veneers from the same flitch alternately face up and face down to produce symmetrical mirror images about the joints between adjacent sheets.

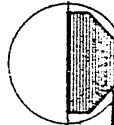
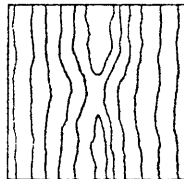
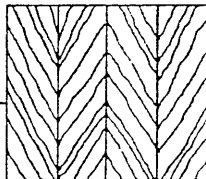


**rotary cutting**

The rotating of a log against the cutting edge of a knife in a lathe, producing a continuous veneer with a bold, variegated ripple figure.

**herringbone matching**

Book matching in which the figures in adjacent sheets slope in opposite directions.

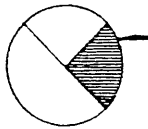
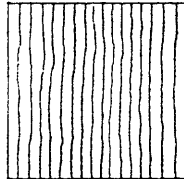
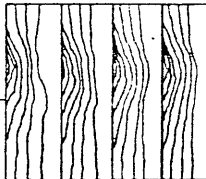


**flat slicing**

The longitudinal slicing of a half-log parallel to a line through its center, producing a veneer having a variegated wavy figure. Also called plain slicing.

**slip matching**

Arranging adjacent sheets of veneer from the same flitch side by side without turning so as to repeat the figure.

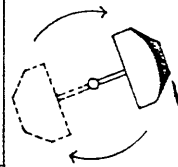
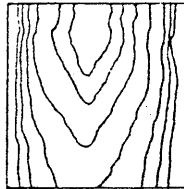
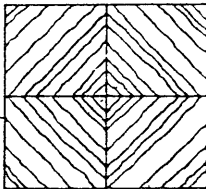


**quarter slicing**

The longitudinal slicing of a quarter log perpendicular to the annual rings, producing a series of straight or varied stripes in the veneer.

**diamond matching**

Arranging four diagonally cut sheets of a veneer to form a diamond pattern about a center.



**half-round slicing**

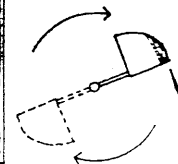
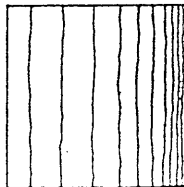
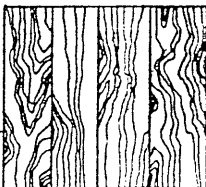
The slicing of a flitch mounted off-center in the lathe, slightly across the annual rings, producing characteristics of both rotary cutting and flat slicing.

**flitch**

A longitudinal section of a log to be cut into veneers.

**random matching**

Arranging veneers to intentionally create a casual, unmatched appearance.



**rift cutting**

The slicing of oak and similar species perpendicular to the conspicuous, radiating rays so as to minimize their appearance.

## WOOD

### oriented strandboard

A nonveneered wood panel product commonly used for sheathing and as subflooring, made by bonding three or five layers of long, thin wood strands under heat and pressure using a waterproof adhesive. The surface strands are aligned parallel to the long axis of the panel, making the panel stronger along its length.

Abbr.: OSB

### waterboard

A nonveneered panel product composed of large, thin wood flakes bonded under heat and pressure with a waterproof adhesive. The planes of the wafers are generally oriented parallel to the plane of the panel but their grain directions are random, making the panel approximately equal in strength and stiffness in all directions in the plane of the panel.

### composite panel

A wood panel product consisting of two face veneers bonded to a reconstituted wood core.

### particleboard

A nonveneered wood panel product made by bonding small wood particles under heat and pressure, commonly used as a core material for decorative panels and cabinetwork, and as underlayment for floors. Also called chipboard.

### parallel strand lumber

A structural lumber product made by bonding long, narrow wood strands together under heat and pressure using a waterproof adhesive. Parallel strand lumber is a proprietary product marketed under the trademark, Parallam, used as beams and columns in post-and-beam construction and for beams, headers, and lintels in light frame construction.

Abbr.: PSL

### laminated veneer lumber

A structural lumber product made by bonding layers of wood veneers together under heat and pressure using a waterproof adhesive. Having the grain of all veneers run in the same longitudinal direction results in a product that is strong when edge loaded as a beam or face loaded as a plank.

Laminated veneer lumber is marketed under various brand names, as Microlam, and used as headers and beams or as flanges for prefabricated wood I-joists. Abbr.: LVL

### fiberboard

A building material made of wood or other plant fibers compressed with a binder into rigid sheets.

### hardboard

A very dense, compressed wood fiberboard.

### tempered hardboard

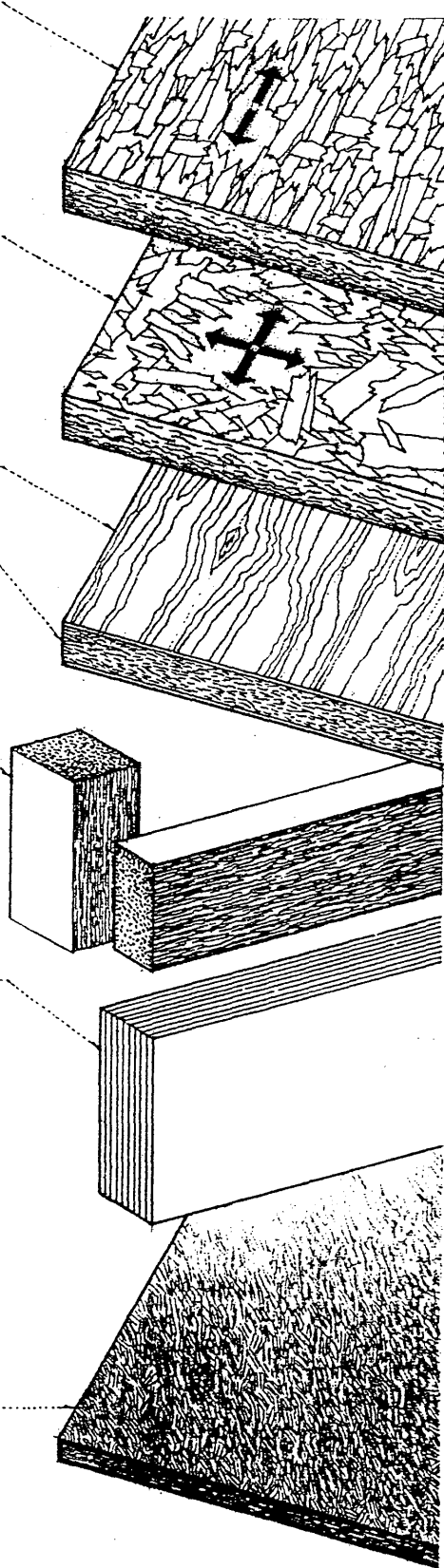
A hardboard impregnated with a drying oil or other oxidizing resin and baked to improve its hardness and moisture resistance.

### Masonite

Trademark for a brand of tempered hardboard.

### Peg-Board

Trademark for a brand of tempered hardboard having regularly spaced perforations into which hooks may be inserted for the storage or display of articles.





## Aa

- Aaron's rod 185  
 abacus 180  
 Abram's law 44  
 abrasion resistance 165  
 abrasion-resistance index 165  
 abscissa 108  
 absolute humidity 120  
 absolute scale 117  
 absolute temperature 117  
 absolute zero 117  
 absorber 124  
 absorbing well 223  
 absorptance 143  
 absorption 18, 160, 165, 231  
 absorption bed 201  
 absorption coefficient 231  
 absorption field 201  
 absorption refrigeration 124  
 absorption trench 201  
 absorption unit 231  
 abstract 52, 59  
 abstract expressionism 135  
 A bulb 144  
 abutment 13, 206  
 Abyssinian well 221  
 acanthus 181  
 accelerated aging 165  
 accelerated weathering 165  
 acceleration of gravity 167  
 accelerator 43  
 accent lighting 148  
 access 57  
 access flooring system 93  
 accident 59  
 acclimatize 277  
 accommodation 264  
 accordion door 62  
 accouplement 179  
 achromatic 39  
 acorn nut 84  
 acoustical analysis 230  
 acoustical ceiling 31  
 acoustical cloud 230  
 acoustical design 230  
 acoustical door 65  
 acoustical plaster 188  
 acoustical tile 31  
 acoustical treatment 230  
 acoustic decking 93  
 acoustic mass 232  
 acoustics 230  
 acre 166  
 acropolis 250  
 acroterium 250  
 acroterion 250  
 acrylic resin 192  
 acrylonitrile-butadiene-styrene 192  
 act curtain 257  
 act drop 257  
 actinic ray 187  
 action 58  
 active earth pressure 100  
 active leaf 62  
 active solar-heating system 226  
 acute 109  
 acute angle 108  
 adaptation 148  
 additive 43, 52  
 additive color 38  
 address 59  
 adhered veneer 156  
 adiabatic cooling 120  
 adiabatic heating 120  
 adjacent spaces 218  
 adjustable doorframe 65  
 adjustable tie 156  
 admixture 43  
 adobe 34  
 adsorption 165  
 advancing color 39  
 aerator 197  
 aerial perspective 72  
 aerodynamic damping 245  
 aerodynamic oscillation 154  
 aesthetics 10  
 A-frame 104  
 aggregate 43  
 agitator truck 46  
 agora 250  
 A-grade 282  
 agreement 54  
 airborne sound 230  
 air chamber 198  
 air change 127  
 air conditioner 124  
 air conditioning 124  
 air curtain 62  
 air cushion 198  
 air-dried 277

- air duct 122  
 air-entraining agent 43  
 air-entraining portland cement 42  
 air gap 198  
 air-handling unit 125  
 air-inflated structure 168  
 air mile 166  
 air-supported structure 168  
 air switch 79  
 air terminal 77  
 air trap 198  
 air-water system 126  
 airway 119  
 aisle 35, 257  
 alabaster 188  
 albarium 189  
 albronze 175  
 albumum 276  
 alclad 175  
 alcove 216  
 alidade 247  
 aligning punch 86  
 alignment 54  
 alignment valve 199  
 alkyd paint 187  
 alkyd resin 187  
 all-air system 126  
 allée 27  
 Allen head 83  
 allowable bearing capacity 100  
 allowable bearing pressure 100  
 allowable load 240  
 allowable pile load 102  
 allowable soil pressure 100  
 allowable stress 164  
 allowable stress design 240  
 allowable unit stress 164  
 alloy 170  
 alloy steel 170  
 allure 37  
 all-water system 126  
 almemar 250  
 alpha-beta brass 175  
 altar 35, 250  
 alternating current 75  
 alternative 58  
 alternator 75  
 altitude 109, 226  
 alto-relievo 182  
 alumina 175  
 aluminum 175  
 aluminum brass 175  
 aluminum bronze 175  
 aluminum oxide 175  
 alure 37  
 amalaka 253  
 ambiance 217  
 ambient sound 231  
 ambiguity 59  
 ambo 35  
 ambon 35  
 ambulatory 35, 37  
 amenity 58  
 American bond 20  
 American standard beam 172  
 American standard channel 172  
 Americans with Disabilities Act 51  
 amorphous 161  
 amortizement 262  
 amperage 74  
 ampere 74  
 amphiprostyle 251  
 amphitheater 256  
 amplitude 152, 228  
 anaglyph 182  
 analogous color 39  
 analogy 59  
 analysis 58  
 analytical drawing 66  
 analytique 67  
 anamorphosis 73  
 Anatolia 128  
 anchor 65, 206, 269  
 anchorage 202, 206, 242  
 anchor bolt 267  
 anchored veneer 156  
 ancon 186  
 ang 254  
 angel light 275  
 angle 108, 172  
 angle bead 190  
 angle cleat 174  
 angle clip 174  
 angle iron 172  
 angle joint 140  
 angle of incidence 143  
 angle of reflection 143  
 angle of refraction 143  
 angle of repose 270  
 angle of slide 270  
 angle tile 214  
 angle valve 199  
 Anglo-Saxon architecture 131  
 angstrom 142  
 anhydrous 188  
 animated 217  
 anion 161  
 anisotropic 162  
 anneal 169  
 annealed glass 112  
 annual ring 276  
 annular vault 263  
 annulet 180  
 annunciator 81  
 anode 74  
 anodize 171  
 anomaly 54  
 anse de panier 14  
 anta 251  
 antefix 250  
 anteroom 216  
 anthemion 184  
 anthropology 11  
 anthropometry 57  
 anthropomorphize 57  
 antic 183  
 anticlastic 219  
 anticorrosive paint 187  
 anticum 250  
 antimony 175  
 anti-scald faucet 197  
 anvil 102  
 apartment building 139  
 apartment house 139  
 apophyge 181  
 apophysis 181  
 apothem 109  
 appearance grade 281  
 appearance lumber 279  
 apprentice 208  
 appliance circuit 77  
 applied force 97  
 appliqué 182  
 apron 257, 271  
 apron piece 235  
 apse 35  
 apsis 35  
 apteral 251  
 aquifer 196  
 arabesque 184  
 areostyle 179  
 arbor 27  
 arc 86, 110  
 arcade 36  
 arcature 36  
 arc-boutant 262  
 arc doubleau 263  
 arch 12  
 arch action 13  
 arch axis 13  
 arch brace 210  
 arch corner bead 190  
 archetype 59  
 arching 100  
 architect 48  
 architectonics 11  
 architectural bronze 175  
 architectural concrete 47  
 architectural hardware 114  
 architectural terra cotta 34  
 architecture 9  
 architrave 179, 186  
 archivolt 12  
 arch order 251  
 arcuate 36, 106  
 arc welding 86  
 are 166  
 area 166  
 area frame 223  
 area of refuge 91  
 area plan 69  
 area source 147  
 areaway 23  
 arena theater 257  
 areostyle 179  
 ark of the covenant 250  
 armature 75  
 armored cable 78  
 arris 185  
 arris fillet 214  
 arris gutter 209  
 arris tile 214  
 art 10  
 Art Deco 135  
 artesian well 196

- articulate 141  
 artificial horizon 247  
 artificial sky 150  
 articulation 52  
 Art Nouveau 134  
 Arts and Crafts Movement 134  
 A/SB bulb 144  
 ashlar 158  
 ashpit 87  
 ashpit door 87  
 aspect 59, 264  
 aspect ratio 109  
 asphalt 215  
 asphalt mastic 176  
 asphalt shingle 212  
 Assyrian architecture 129  
 astragal 62, 185  
 asymptote 110  
 atlas 250  
 atmosphere 167  
 atmospheric pressure 167  
 atom 161  
 atomic number 161  
 atomic weight 161  
 atrium 26, 35, 137  
 attenuation 230  
 Atterberg limits 225  
 attic 23  
 Attic base 181  
 attic ventilator 127  
 audio frequency 229  
 auditorium 258  
 auditory fatigue 229  
 aureole 183  
~~automatic closing fire assembly 89~~  
 automatic door 62  
 automatic door bottom 114  
 automatic fire extinguishing system 90  
 autumnal equinox 226  
 auxiliary rafter 210  
 avant-garde 135  
 average transmission loss 232  
 award 49  
 awning 274  
 awning window 273  
 axial force 162  
 axial load 162  
 axial stress 162  
 axis 55  
 axis of abscissas 108  
 axis of ordinates 108  
 axis of symmetry 55  
 axonometric 71  
 axonometric projection 71  
 azimuth 246  
~~Aztec architecture 132~~
- Bb**
- back 271  
 backband 271  
 backband 65  
 backcheck 114  
 backfill 222  
 backflap hinge 115  
 backflow 198  
 backflow valve 198  
 background 265  
 background noise 231  
 background noise level 231  
 back hearth 87  
 backing 95, 156, 211, 267  
 backing board 191  
 backing grade 283  
 backlight 148  
 back plaster 156  
 backset 116  
~~back-siphonage 198~~  
 backsplash 198  
 backstage 258  
 backup rod 178  
 backup wall 269  
 back vent 200  
 backwater valve 198  
 baffle 146  
 baguette 185  
 bailey 98  
 Bakelite 193  
 balance 55  
 balanced door 62  
 balanced sash 272  
 balanced section 202  
 balanced step 234  
 balconet 273  
 balcony 24, 258  
 baldachin 35  
 baldaquin 35  
 ballast 145  
 ball-bearing hinge 115  
 ball cock 198  
 ballflower 183  
 balloon frame 267  
 baluster 235  
 balustrade 235  
 band 228  
 bandage 61  
 banderole 184  
 banding 283  
 bandrole 184  
 banister 235  
 bank 80  
 baptism 35  
 baptistery 35  
 bar 172  
 barbacan 99  
 bargeboard 211  
 barge couple 211  
 barge course 214  
 bar joist 173  
 bark 276  
 barometer 167  
 barometric pressure 167  
 Baroque architecture 133  
 barrel roof 208  
~~barrel shell 219~~  
 barrel vault 263  
 barrier-free 57  
 barrow 248  
 bartizan 99  
 bar tracery 275  
 base 109, 153, 179  
 base anchor 65  
 baseboard 186  
 baseboard heater 123  
 basecoat 187, 188  
 base flashing 177  
 base isolation 245  
 base line 72, 246, 247  
 basement 23  
 basement wall 266  
 base metal 86, 170  
 base molding 186  
 base plate 174  
 base screed 190  
 base shear 153  
 base shear coefficient 153  
 base sheet 215  
 base shoe 186  
 base value 280  
 basic wind speed 154  
 basilica 35, 251  
 basket-handle arch 14  
 bas-relief 182  
 basso-relievo 182  
 bastard pointing 155  
 bastard-saw 278  
 bastion 98  
 bat 19  
 bathtub 198  
 batted surface 237  
 batten 214, 257, 268  
 batten door 64  
 batten seam 214  
 batter 270  
 batter board 221  
 batter pile 102  
 battery 74, 200  
 batt insulation 119  
 battlement 99  
 Bauhaus 135  
 bauxite 175  
 bay 24, 239  
 Bayer process 175  
 bay window 274  
 B bulb 144  
 bead 86, 178, 185, 214  
 bead and reel 185  
 bead molding 28  
 beak 185  
 beam 15, 149  
 beam-and-girder slab 204  
 beam ceiling 30  
 beam fill 93  
 beam pocket 93  
 beams and stringers 279  
 beam seat 85  
 beam spread 149  
 bearing 241, 246  
 bearing stiffener 173  
 bearing stratum 102  
 bearing stress 241  
 bearing wall 266  
 bearing wall system 244  
 beauty 10  
 Beaux Arts architecture 132  
 bed 155

- bedding 113  
 bedding plane 237  
 bed joint 155  
 bed molding 179  
 bedrock 224  
 beehive tomb 248  
 behavioral science 11  
 Belfast truss 261  
 Belgian 261  
 bell 103, 181, 199  
 bell-and-spligot 199  
 bell arch 14  
 bell bucket 103  
 below grade 222  
 belt course 159  
 belvedere 27  
 bema 35, 250  
 bench mark 247  
 bench terrace 222  
 bending 163  
 bending member 238  
 bending moment 15  
 bending stress 15  
 bent 105  
 bent approach 255  
 bent bar 203  
 bentonite 224  
 berm 98, 227  
 Bernoulli equation 154  
 Bernoulli's theorem 154  
 béton armé 202  
 béton brut 47  
 bevel 116, 141  
 bevel siding 268  
 B-grade 282  
 bidding 49  
 bidet 198  
~~blind door 62~~  
 bifurcation 40  
 bilateral symmetry 55  
 bilection 268  
 bi-level 138  
~~bill 169, 185~~  
 bimin 250  
 bimetallic element 121  
 binder 107, 158, 187  
 binding beam 107  
 binding rafter 210  
 binocular vision 264  
 bin wall 270  
 bird's-beak 185  
 bird's-mouth 211  
 biscuit 32  
 bisque 32  
 bisque-fired 32  
 bit 116  
 bite 113  
 bitumen 215  
 black label 213  
 blackplate 172  
 blank 169  
~~blanket insulation 119~~  
 blank jamb 63  
 blast furnace 170  
 blast-furnace slag 170  
 bleeder 123  
 bleeder valve 123  
 bleeding 46  
 blind 24  
 blind arcade 36  
 blind casing 272  
 blind door 64  
 blind floor 92  
 blinding glare 148  
 blind mortise 141  
 blind-nail 82  
 blind row 257  
 blindstory 24  
 blind wall 266  
 block 26  
 block flooring 94  
 blocking 267  
 bloom 169  
 blooming mill 169  
 blow 221  
 blower 125  
 blow molding 192  
 blue label 213  
 bluestone 236  
 board and batten 268  
 board foot 277  
 boarding 268  
 board measure 277  
 boards 279  
 boasted surface 237  
 BOCA National Building Code 51  
 body 32, 111  
 boil 221  
 boiler 123  
 bolection 268  
 bolster 12, 45, 281  
 bolt 84, 116  
 boltel 185  
 bond 20, 157, 161, 202  
 bond beam 160  
 bond-beam block 160  
 bond breaker 178  
 bond coat 33  
 bond course 20  
 bonded 48  
 bonded posttensioning 207  
 bonded terrazzo 94  
 bondertize 171  
 bond face 178  
 bonding agent 94, 190  
 bonding layer 204  
 bond plaster 188  
 bondstone 158  
 bond stress 202  
 bonnet 87, 122, 199  
 bonnet tile 214  
 book matching 283  
 boot 122  
 border 257  
 borrowed light 274  
 borrow pit 222  
 boss 159, 263  
 Boston hip 213  
 Boston ridge 213  
 bottom bar 203  
 bottom car clearance 80  
 bottom rail 64  
 boulder 224  
 boundary cable 29  
 boutel 185  
 bow 278  
 bower 99  
 Bow's notation 260  
 bowstring truss 261  
 bowtel 185  
 bow window 274  
 box beam 281  
 box column 174, 281  
 box cornice 213  
 box culvert 223  
 boxed frame 272  
 box girder 173  
 box gutter 209  
 box-head window 272  
 box nail 82  
 box office 258  
 box sill 267  
 box stair 235  
 box strike 116  
 Boyle's law 167  
 brace 243  
 braced core 245  
 braced frame 104, 107, 243  
 braced tube 245  
 brace molding 185  
 bracket 210, 235  
 bracket load 281  
 brad 82  
 branch 197  
 branch circuit 77  
 branch drain 200  
 branch interval 200  
 branch vent 200  
 brass 175  
 brattice 99  
 braze 86  
 breakdown voltage 78  
~~brake 74~~  
 break joints 212  
 break line 68  
 breast beam 107  
 breastsummer 107  
 breast timber 45  
 breast wall 270  
 breezeway 138  
 brick 18  
 brick grade 18  
 brick molding 271  
 brick type 18  
 brickwork 20  
 bridge 257  
 bridge lamp 147  
 bridging 92  
 bride joint 141  
 brightness 38, 142  
 brightness ratio 148  
 brilliant 38  
 Brinell number 165  
 prise-soleil 227  
 British thermal unit 117

- brittleness 164  
 broken pediment 186  
 broken rangework 158  
 bronze 175  
 Bronze Age 128  
 broom finish 47  
 brown coat 188  
 brownstone 139, 236  
 brush 75  
~~brush~~ 135  
 BT bulb 145  
 buck 63  
 bucket trap 123  
 buckling 40  
 buckling load 40  
 Buddha 253  
 Buddhism 253  
 Buffalo box 196  
 buffer 80  
 buggy 46  
 bugle head 83  
 building 21  
 building brick 18  
 building code 51  
 building drain 200  
 building official 49  
 building paper 268  
 building permit 49  
 building separation 153  
 building sewer 200  
 building stone 237  
 building storm drain 223  
 building storm sewer 223  
 building trap 200  
 building type factor 153  
 built-up beam 281  
 built-up column 174, 281  
 built-up roofing 215  
 bulb 103, 144  
 bulk-active structure 238  
 bulkhead 23, 45, 80  
 bulking 165  
 bulk modulus 162  
 bull float 47  
 bullnose 185  
 bullnose block 160  
 bullnose corner bead 190  
 bull's nose 185  
 bullstretcher 19  
 bumper 114  
 bundled tubes 245  
 bungalow 138  
 bungalow court 138  
 burden 221  
~~burden~~  
 bus bar 76  
 bus duct 78  
 bushhammered finish 47  
 bushing 78  
 busway 78  
 butsu 255  
 butsuden 255  
~~butt~~ 115, 218  
 butterfly 140  
 butterfly roof 208  
 butterfly wedge 140  
 butt hinge 115  
 butt joint 140  
 butt-joint glazing 113  
 buttonhead 83  
 butt plate 174  
 buttress 262  
 buttress pier 262  
 butts and bounds 246  
 butt splice 203  
 butt weld 86  
 Butyl 193  
 butyl rubber 193  
 BX cable 78  
 Byzantine architecture 130  
  
**Cc**  
 cabinet drawing 71  
 cable 28, 78  
 cable loop 168  
 cable molding 185  
 cable-restrained pneumatic structure 168  
 cable-stayed structure 29  
 cable structure 28  
 cable support 242  
 cable tray 78  
 CA bulb 144  
 cadastral survey 246  
 cadmium 175  
 cairn 248  
 caisson 30, 103  
 calcine 42  
 calcined gypsum 188  
 calcium hydroxide 157  
 calcium oxide 157  
 calendaring 192  
 calf's tongue 184  
 call button 81  
 calorie 117  
 cab 157  
 cam 116  
 camber 15  
 camber bar 87  
 camber piece 12  
 camber slip 12  
 cambium 276  
 camelback truss 261  
 cam handle 273  
 camouflage 265  
 campanile 36  
 camp ceiling 30  
 cancell 35  
 candela 142  
 candle 142  
 candlepower 142  
 candlepower distribution curve 146  
 canephora 250  
 cant 109  
 cant bay window 274  
 cantharus 35  
 cantilever 17  
 cantilever beam 17  
 cantilevered step 235  
 cantilever footing 101  
 cantilever method 105  
 cantilever wall 270  
 canton 266  
 cant strip 177  
 cap 199  
 cap bead 113  
 cap block 160  
 cap flashing 177  
 Cape Cod 138  
 capillarity 177  
 capillary action 177  
 capillary attraction 177  
 capillary break 177  
 capital 179  
 cap nut 84  
 cap plate 174  
 cap receiver 177  
 capscrew 83  
 cap sealant 113  
 cap sheet 215  
 capstone 159  
 caravansary 252  
 carbide 175  
 carbon 170  
 carbon steel 170  
 car frame 81  
 carn 248  
 Carolingian architecture 131  
 Carpenter Gothic 134  
 carpet 95  
 carpet cushion 95  
 carpet pad 95  
 carpet tile 95  
 carriage 235  
 carriage bolt 84  
 carriage porch 25  
 Cartesian coordinate 108  
 Cartesian space 217  
 cartoon 67  
 cartouché 183  
 cartridge fuse 76  
 carved work 237  
 caryatid 250  
 cased opening 63  
 cased pile 103  
 case-harden 169  
 casemate 98  
 casement 273  
 casement door 64  
 casement stay 273  
 casement window 273  
 casing 63, 103  
 casing bead 190  
 casing nail 82  
 castellated beam 173  
 castellated nut 84  
 casting 169, 192  
 casting bed 206  
 cast-in-place concrete 46  
 cast-in-place concrete pile 103  
 cast-in-situ concrete 46  
 cast iron 170  
 castle 99  
 castle nut 84  
 cast stone 237  
 Catal Hüyük 128

- catalyst 192  
 catch basin 223  
 catenary 28  
 cathedral 37  
 Catherine wheel 36  
 cathetus 181  
 cathode 74  
 cathodic protection 171  
 cation 161  
 caulcole 181  
 cauliculus 181  
 caulk 178  
 causeway 249  
 caustic lime 157  
 cavalier drawing 71  
 cavetto 185, 249  
 cavetto cornice 249  
 cavity wall 156  
 cavo-relievo 182  
 C bulbs 144  
 ceiling 30  
 ceiling cavity 149  
 ceiling joist 211  
 cell 74  
 cella 250  
 cellar 23  
 cellular decking 93  
 cellular mat 101  
 cellular wall 270  
 cellulose 276  
 Celsius scale 117  
 Celtic cross 183  
 cement 42  
 cement content 44  
 cement-lime mortar 157  
 cement mortar 157  
 cement paste 43  
 cement temper 188  
 cenotaph 251  
 center 110, 111, 217  
 centering 12  
 centering shim 113  
 centerline 68, 110  
 center of gravity 96  
 center of mass 96  
 center of resistance 244  
 center of rigidity 244  
 center of vision 72  
 center-to-center 267  
 Centigrade scale 117  
 centimeter 166  
 central air conditioning 125  
 central axis of vision 72  
 central heating 121  
 centralized organization 218  
 centrifugal fan 127  
 centroid 96  
 ceramic 32  
 ceramic bond 32  
 ceramic mosaic tile 33  
~~ceramic tile~~  
 ceramic ware 32  
 cercis 256  
 certificate of occupancy 49  
 cesspool 201  
 C-grade 282  
 chain 247  
 chair 45  
 chair rail 186  
 chaitya 253  
 chamber grave 248  
 chamfer 140  
 chamfer strip 45  
 chancel 37  
 chandelier 147  
 chantry 37  
 chaos 54  
 chapel 37, 99  
 chapter 37  
 chapter house 37  
 charrette 58  
 chase 122  
 chase mortise 141  
 chat-sawn 237  
 chattri 253  
 Chavin 129  
 check 278  
 checker 184  
 checkered plate 172  
 check rail 272  
 check throat 271  
 check valve 199  
 cheek 209  
 cheek cut 211  
 chemical bond 161  
 chemin-de-ronde 99  
 chevet 37  
 chevron 184  
 Chicago School 135  
 chigi 255  
 chilled water plant 125  
 chiller 125  
 chimney 87  
 chimney arch 87  
 chimney bar 87  
 chimney breast 87  
 chimney cap 87  
 chimney cheek 87  
 chimney corner 87  
 chimney effect 127  
 chimney pot 87  
~~chimney stack~~  
 Ch'in 129  
 china 32  
 china clay 32  
 Chinese architecture 128  
 Chinese lacquer 187  
 chiniserie 133  
 chipboard 284  
 Chi-Rho 183  
 chisel point 82  
 choir 37  
 chord 110, 259  
 chorten 253  
 chorus 256  
 Chou 129  
 chrismon 183  
 Christianity 35  
 chroma 38  
 chrome 171  
 chromeplate 171  
 chromium 171  
 chudo 255  
 chumon 255  
 chute 46  
 ciborium 35  
 CIE 150  
 cinder 170  
 Cinquecento architecture 133  
 cinquefoil 275  
 circle 110  
 circuit 74  
 circuit breaker 76  
 circuit vent 200  
 circular mill 166  
 circular stair 234  
 circulation 218  
 circumference 110  
 circumvallate 98  
 cistern 196  
 citadel 99  
 city planning 10  
 civilization 128  
 cladding 171  
 claim 27  
 clapboard 268  
 class A 89  
 class A fire 90  
 class B 89  
 class B fire 90  
 class C 89  
 class C fire 90  
 class D 89  
 class D fire 90  
 class E 89  
 Classic 130  
 Classical architecture 130  
 classicism 133  
 Classic Revival 133  
 clay 224  
 clay loam 224  
 cleanout 157, 200  
 clear sky 150  
 clear span 15  
 clear story 274  
 cleat 214  
 cleavage plane 237  
 clerestory 274  
 clevis 84  
 climbing form 45  
 clinch 82  
 clinker 18, 42  
 clip joint 155  
 clithral 251  
 cloister 37  
 cloister garth 37  
 cloister vault 263  
 close 37  
 closed cornice 213  
 closed plan 216  
 closed string 235  
 closed valley 212  
 close grain 278  
 closer 20, 155  
 closet bend 199

- closure 20, 265  
 cloudy sky 150  
 clustered organization 218  
 cluster housing 139  
 coach screw 83  
 coal tar 215  
 coarse aggregate 43  
 coarse grain 278  
 coarse texture 278  
 coaxial cable 78  
 cobble 224  
 cobblestone 224  
 cock bead 268  
 cocking piece 213  
 Code of Hammurabi 129  
 coefficient of elasticity 164  
 coefficient of expansion 165  
 coefficient of heat transfer 118  
 coefficient of utilization 149  
 coffer 30  
 cofferdam 221  
 coherent 54  
 cohesionless soil 225  
 cohesive soil 225  
 coil 75, 126  
 coincident 109  
 coke 170  
 cold-air return 122  
 cold-cathode lamp 145  
 cold-draw 169  
 cold-process roofing 215  
 cold-roll 169  
 cold-working 169  
 collage 54  
 collapse mechanism 243  
 collar 177  
 collar beam 211  
 collar joint 155  
 collar tie 211  
 collector 226  
 collegiate Gothic 134  
 collimate 146  
 collinear forces 96  
 Colonial architecture 133  
 colonial siding 268  
 colonnade 25  
 color 38  
 color circle 39  
 colorfast 187  
 coloring agent 43  
 color rendering Index 145  
 color scheme 39  
 color temperature 145  
 color triangle 39  
 color wheel 39  
 column 40, 179  
 column base 85  
 column cap 85  
 column capital 205  
 column-cover-and-spandrel system 269  
 columniation 179  
 column strip 204  
 colymbethra 28  
 combed finish 189  
 combination door 64  
 combination window 274  
 combined footing 101  
 combined sewer 223  
 combined stresses 41, 163  
 combplate 81  
 combustible 88  
 combustible construction 51  
 combustion air 121  
 comfort envelope 120  
 comfort zone 120  
 commercial bronze 175  
 commodity 10  
 common alloy 175  
 common bond 20  
 common brass 175  
 common brick 18  
 common dovetail 141  
 common lap 212  
 common logarithm 229  
 common nail 82  
 common rafter 210  
 commons 139  
 common vent 200  
 communicate 58  
 communion table 35  
 compact fluorescent lamp 145  
 compaction 225  
 complementary color 39  
 complexity 54  
 compluvium 137  
 components of a force 96  
 composite column 203  
 composite decking 93  
 Composite order 181  
 composite panel 284  
 composite pile 102  
 composite truss 261  
 composite wall 156  
 composition 53  
 compound column 203  
 compressibility 162  
 compression 162  
 compression gasket 113  
 compression member 238  
 compression molding 192  
 compression reinforcement 202  
 compression splice 203  
 compression test 44, 162  
 compressive force 162  
 compressive refrigeration 124  
 compressive strain 162  
 compressive stress 162  
 compressor 124  
 concatenation 55  
 concave 110  
 concave joint 155  
 concealed grid 31  
 concealed hinge 115  
 conceive 58  
 concentrated load 151  
 concentric 110  
 concentric tendon 207  
 concept 59  
 conception 67  
 concrete 42  
 concrete block 160  
 concrete brick 160  
 concrete masonry unit 160  
 concrete mixer 46  
 concrete nail 82  
 concurrent forces 96  
 condensate 176  
 condensation 176  
 condense 161  
 condenser 124  
 condominium 139  
 conduction 118  
 conductivity 74  
 conductor 78  
 conduit 78  
 cone 45  
 cone bolt 45  
 cone of vision 72  
 configurationism 265  
 Confucianism 129  
 congé 185  
 congruent 109  
 conical vault 263  
 conic section 111  
 conifer 276  
 connected load 77  
 connection 59  
 connector 79  
 conoid 220  
 consistency 44  
 console 186  
 consolidation 46, 100  
 constancy 265  
 constant-air-volume system 126  
 construction 48, 49, 50  
 construction class 51  
 construction documents 50  
 construction drawings 68  
 construction joint 178  
 construction load 151  
 construction manager 48  
 construction type 51  
 Constructivism 135  
 consultant 48  
 contact pressure 100  
 content 53  
 continental seating 257  
 continuity 54, 265  
 continuity of outline 72  
 continuous beam 17  
 continuous footing 101  
 continuous hinge 115  
 continuous plate 194  
 continuous slab 204  
 continuous vent 200  
 contour 66  
 contour drawing 66  
 contour interval 69  
 contour line 69  
 contract 49  
 contract documents 50  
 contract drawings 68  
 contraction joint 178  
 contract limit 221  
 contractor 48

- contradiction 54  
 contrast 54  
 contrast ratio 148  
 contributory area 241  
 contrive 58  
 control joint 178, 190  
 control-joint block 160  
 controlled fill 222  
 control panel 80  
 convection 118  
 convector 123  
 convenience outlet 79  
 convergence 73, 264  
 conversion burner 121  
 conversion table 166  
 convex 110  
 cool 39  
 coolant 124  
 cooling degree-day 124  
 cooling load 124  
 cooling medium 124  
 cooling tower 125  
 co-op 139  
 cooperative 139  
 cooperative apartment 139  
 coordinate 108  
 coordinator 116  
 copal 187  
 coped joint 140  
 copestone 159  
 coping 266  
 coping block 160  
 coplanar forces 96  
 copolymer 192  
 copper 175  
 copper roofing 214  
 corbel 155  
 corbel arch 14  
 corbeling 155  
 corbel vault 262  
 corbie gable 159  
 corblestep 159  
 cord 79  
 cordon 98, 159  
 cone 65, 75, 160, 225, 283  
 coreboard 191  
 core test 44  
 Corinthian order 181  
 cork tile 95  
 corner bead 190  
 corner block 160  
 corner board 268  
 corner brace 267  
 corner lath 190  
 corner post 267  
 corner reinforcement 190  
 cornice 179, 186  
 cornice lighting 147  
 cornice return 213  
 corona 179  
 coronet 186  
 corporation cock 196  
 corporation stop 196  
 correction line 246  
 corridor 216  
 corrosion 171  
 corrugated fastener 82  
 corrugated metal 172  
 corrugated roofing 214  
 cortile 26  
 cosecant 109  
 cosine 109  
 cosine law 142  
 cotangent 109  
 coulomb 28  
 counterbore 84  
 counterbrace 259  
 counterflashing 177  
 counterfort 270  
 counterlight 150  
 counterpoint 54  
 counterpoise 55  
 counterscarp 98  
 countersink 83  
 counterweight 80  
 couple 96, 211  
 couple-close 211  
 coupling 199  
 course 155, 246  
 coursed ashlar 158  
 coursed rubble 158  
 court 26  
 courtyard 26  
 covalent bond 161  
 cove 30, 185  
 cove ceiling 30  
 cove lighting 147  
 cover 202  
 coverage 187, 212  
 covering power 187  
 cover plate 173  
 cowl 87  
 C-plugged grade 282  
 CPM 49  
 cracked section 202  
 cracking load 202  
 cradle vault 263  
 cramp iron 158  
 crawlspace 23  
 crazing 47  
 creative imagination 59  
 creativity 59  
 creep 165  
 cremona bolt 273  
 crenel 99  
 crenelated 99  
 crenelle 99  
 creosote 280  
 crepidoma 250  
 crescent 139  
 crescent truss 261  
 crib 270  
 cribbing 270  
 cribwork 270  
 cricket 209  
 cripple 267  
 cripple jack 211  
 criterion 58  
 critical angle 233  
 critical buckling load 40  
 critical buckling stress 40  
 critical density 225  
 critical height 270  
 critical section 202  
 critical void ratio 225  
 crocket 37  
 cromlech 248  
 crook 278  
 cross 183, 199  
 crossband 65, 283  
 cross bracing 243  
 crossbridging 92  
 cross-contour drawing 66  
 crosscut 278  
 cross formée 183  
 cross-garnet 115  
 cross grain 278  
 crosshatching 66  
 crossing 36  
 cross-lap joint 141  
 crosslight 150  
 crossover 199  
 cross section 70  
 cross tee 31  
 cross vault 263  
 cross ventilation 127  
 crowfoot 68  
 crown 12, 276  
 crown glass 112  
 crown molding 186  
 crown post 261  
 crown tile 214  
 crowstep 159  
 cruck 210  
 crushed gravel 224  
 crushed rock 224  
 crushed stone 224  
 crypt 37  
 crystal 161  
 cube 111  
 cubic measure 166  
 cubism 135  
 cul-de-four 61  
 cull 18  
 cult temple 249  
 culture 128  
 culvert 223  
 cup 278  
 cupola 61  
 curb 208  
 curb box 196  
 curb cock 196  
 curb cut 221  
 curb roof 208  
 curb stop 196  
 cure 47  
 current 74  
 curtail 235  
 curtail step 235  
 curtain 98  
 curtain wall 269  
 curve 110  
 Curvilinear style 132  
 curvilinear tracery 275  
 cushion 102



- cushion block 102  
 cushion head 102  
 cushion rafter 210  
 cusp 110, 275  
 cusplation 275  
 cut and fill 222  
 cut-and-mitered string 235  
 cutaway 71  
 cut nail 82  
 cutoff 223  
 cutoff stop 65  
 cut pile 95  
 cut stone 237  
 cut string 235  
 cycloid 110  
 cyclone cellar 23  
 cyclopean 158  
 cyclostyle 251  
 cylinder 111, 116  
 cylinder glass 112  
 cylindrical surface 219  
 cyma 185  
 cyma recta 185  
 cyma reversa 185  
 cymatium 179, 181  
 cyrtostyle 251
- Dd**
- Dacron 193  
 dado 140, 179, 268  
 dado joint 140  
 dagoba 253  
 daibutsu 255  
 damp 245  
 damp check 177  
 damp course 177  
 damper 87, 125  
 damping 152  
 damping mechanism 245  
 dampproofing 176  
 dancette 184  
 dancing step 234  
 dancing winder 234  
 dap 140  
 darby 47  
 dark 38  
 Dark Ages 130  
 dash-bond coat 28  
 dashed line 68  
 dash-tracweled finish 189  
 datum 58, 247  
 daubing 189  
 day 271  
 daylight 150  
 daylight factor 150  
 daylighting 150  
 dead 76, 230  
 dead-air space 119  
 deadbolt 116  
 deadknot 278  
 dead load 151  
 deadlock 116  
 deadman 270  
 dead shore 222  
 deadbulatory 37
- decastyle 179  
 decay 278  
 decay rate 230  
 decibel 229  
 deciduous 276  
 deck 25, 93  
 decking 93, 279  
 deconstruction 135  
 decorated shed 135  
 Decorated style 132  
 decorative plywood 283  
 deep 38  
 deep beam 203  
 deep foundation 102  
 defector sheave 80  
 deflection 15  
 deformation 164  
 deformed bar 202  
 degree 108  
 degree-day 121  
 degree of freedom 105  
 degree of indeterminacy 105  
 degree of redundancy 105  
 delight 10  
 deluge system 90  
 demand factor 77  
 demirelief 182  
 demountable partition 266  
 density 167  
 dentil 181  
 dentil band 184  
 depressed tendon 207  
 descriptive geometry 69  
 descriptive specification 50  
 design 52, 58  
 design-build 48  
 design concept 59  
 design drawing 67  
 design load 240  
 design principle 54  
 design process 58  
 design value 280  
 design wind pressure 154  
 design wind velocity 154  
 de Stijl 135  
 detached dwelling 138  
 determinate 105  
 develop 58  
 developed length 199  
 developer 48  
 devise 58  
 dewater 221  
 dew point 120  
 dew-point temperature 120  
 D-grade 282  
 diaconicon 35  
 diagonal 73, 109, 261  
 diagonal bracing 243  
 diagonal grain 278  
 diagonal point 73  
 diagonal rib 263  
 diagonal sheathing 268  
 diagonal slating 213  
 diagonal tension 203  
 diagonal vanishing point 73
- diagram 53  
 diameter 110  
 diamond matching 283  
 diamond point 82  
 diaper 184  
 diaphragm 243  
 diastyle 179  
 diazoma 256  
 dicalcium silicate 42  
 die 169, 179  
 die casting 169  
 dielectric 78  
 dielectric strength 78  
 differential leveling 247  
 differential settlement 100  
 diffracted sound 230  
 diffraction 143  
 diffuse 143  
 diffuser 122, 146  
 diffusion 143  
 dimension line 68  
 dimension lumber 279  
 dimension shingles 213  
 dimension stone 237  
 dimensional stability 165  
 dimetric projection 71  
 diminishing course 213  
 dimmer 79  
 dimmer switch 79  
 dipteral 251  
 direct current 75  
 direct glare 148  
 direct-indirect lighting 148  
 direction 55  
 direct lighting 148  
 Directoire style 133  
 direct placement 46  
 direct return 123  
 directrix 111  
 direct sound 230  
 direct stress 162, 259  
 disability glare 148  
 discharge lamp 145  
 discharging arch 266  
 discomfort glare 148  
 discontinuous construction 232  
 discontinuous diaphragm 244  
 discontinuous shear wall 244  
 discrimination 264  
 displuviate 137  
 disposal 198  
 disposal field 201  
 disposer 198  
 distance point 73  
 distance separation 89  
 distributed load 151  
 distribution box 201  
 distribution cap 168  
 distribution line 201  
 distribution of base shear 153  
 distribution panel 77  
 distribution pipe 201  
 distribution rib 204  
 distyle 179  
 distyle in antis 251

- diversion box 201  
 diversity factor 77  
 dodecahedron 111  
 dodecastyle 179  
 dog-leg stair 234  
 dogtooth 184  
 dogtrot 138  
 dolly 86  
 Dolly Varden siding 268  
 dolmen 248  
 dolomite 236  
 dome 60, 205  
 donjon 99  
 door 62  
 door bevel 63  
 door buck 63  
 door chain 114  
 door check 114  
 door clearance 63  
 door contact 81  
 doorframe 63  
 door interlock 81  
 doorjamb 63  
 doorknob 116  
 door opener 62  
 doorplate 114  
 door pull 114  
 doorskin 28  
 doorstop 63, 114  
 Doppler effect 228  
 Doric cyma 185  
 Doric order 180  
 dormer 209  
 dormer window 274  
 dosing chamber 201  
 dossieret 36  
 dotted line 68  
 dou 254  
 double-acting door 62  
 double-acting hinge 115  
 double angle 172  
 double-bevel weld 86  
 double-cable structure 29  
 double complementary 39  
 double-corner block 160  
 double-curvature structure 29  
 double doors 62  
 double-egress frame 65  
 double-extra-strong pipe 172  
 double-framed roof 210  
 double glazing 113  
 double grid 239  
 double-hung window 272  
 double jack rafter 211  
 double-L stair 234  
 double overhanging beam 17  
 double-return stair 234  
 double roof 210  
 double-strength glass 112  
 double tee 206  
 double-vee weld 86  
 doubling course 212  
 dougong 254  
 dovetail 141  
 dovetail halving 141  
 dovetail hinge 115  
 dovetail joint 141  
 dowel 85, 178  
 dowel pin 85  
 downdraft 87  
 downfeed distribution system 197  
 downlight 147  
 downspout 209  
 draft 58, 67, 87, 237  
 drafted margin 237  
 drafting 68  
 draft stop 89  
 dragged finish 189  
 dragon beam 211  
 dragon piece 211  
 dragon tile 211  
 drain 200  
 drainage mat 176  
 drainage system 200  
 drainage tile 201  
 drainfield 201  
 drainspout 209  
 drain tile 201  
 draped tendon 207  
 Dravidian 130  
 drawbore 141  
 drawbore pin 141  
 drawbridge 99  
 drawdown 196  
 drawing 66  
 drawn finish 169  
 drawn glass 112  
 dress circle 258  
 dressed dimension 277  
 dressed lumber 277  
 dressed size 277  
 dressed stone 237  
 dressing 271  
 dressing room 258  
 drift 13, 86, 152  
 driftbolt 82  
 drift index 153  
 drift limitation 153  
 drift pin 82, 86  
 drip 271  
 drip cap 271  
 drip edge 212  
 drip molding 271  
 dripstone 159  
 drive band 102  
 drivescrew 82  
 drive shoe 102  
 driving sheave 80  
 dromos 248  
 drop 122, 180, 263  
 drop arch 14  
 drop ceiling 31  
 drop chute 46  
 droplight 147  
 drop panel 205  
 dropped ceiling 31  
 dropped girt 107  
 drop-point slating 213  
 drop siding 268  
 drop stage 257  
 drop tee 199  
 drop window 272  
 drum 61, 180  
 drum trap 198  
 drum wall 227  
 dry-bulb temperature 120  
 dry glazing 113  
 drying oil 187  
 drying shrinkage 47  
 dry mix 44  
 dry-pack 174  
 dry-pipe system 90  
 dry-press process 18  
 dry return 123  
 dry rot 278  
 dry-shake finish 47  
 dry standpipe 90  
 drywall 191  
 drywall frame 65  
 dry well 223  
 dual-duct system 126  
 dual system 244  
 dual vent 200  
 duct 78, 122  
 ductility 164  
 ducting 122  
 duct liner 122  
 ductwork 122  
 dumbwaiter 80  
 dungeon 99  
 duodecastyle 179  
 duomo 132  
 duplex 138, 139  
 duplex apartment 139  
 duplex house 138  
 duralumin 175  
 duramen 276  
 duration of load factor 280  
 Dutch bond 20  
 Dutch Colonial 138  
 Dutch door 64  
 Dutch lap 212  
 dwarf wall 267  
 dye 187  
 dynamic fit 57  
 dynamic load 151  
 dynamic pile formula 102  
 dynamics 58, 97  
 dynamic wind pressure 154

**Ee**

- Early Christian Architecture 130  
 Early English style 132  
 Early French style 132  
 Early Renaissance 132  
 early wood 276  
 earthenware 32  
 earth pressure 151  
 earthquake 152  
 earthquake load 152  
 earth tieback wall 270  
 earthwork 221  
 eased edge 140  
 easement 140, 221  
 eaves 209

- eaves course 214  
 eaves flashing 212  
 eaves trough 209  
 E bulb 145  
 eccentric 110  
 eccentric bracing 244  
 eccentric force 162  
 eccentricity 41  
 eccentric load 162  
 eccentric tendon 207  
 echinus 180, 181  
 echo 230  
 eclectic 134  
 eclecticism 134  
 economy 58  
 economy brick 19  
 economy wall 156  
 ectype 59  
 edge 111, 218  
 edge block 113  
 edge clearance 113  
 edge distance 84  
 edge grain 278  
 edge joint 140  
 edger 47  
 edifice 22  
 effective area of concrete 202  
 effective area of reinforcement 202  
 effective depth 202  
 effective length 17, 41  
 effective length factor 41  
 effective prestress 206  
 effective span 15  
 effective temperature 120  
 efficacy 144  
 efficiency apartment 139  
 efflorescence 18  
 effluent 201  
 egg and dart 181  
 egg and tongue 181  
 eggcrate 146  
 eggshell 187  
 egg stone 236  
 Egyptian architecture 128  
 Egyptian Gorge 249  
 eightpenny nail 82  
 el 26, 199  
 elastic deformation 164  
 elastic design 240  
 elasticity 164  
 elastic limit 164  
 elastic modulus 164  
 elastic range 164  
 elastomer 193  
 elastomeric 215  
 elastomeric roofing 215  
 elbow 199  
 electrical metallic tubing 78  
 electric arc 86  
 electric cell 74  
 electric charge 74  
 electric elevator 80  
 electric furnace 121  
 electric heat 123  
 electricity 74  
 electric motor 75  
 electrode 74  
 electrolysis 171  
 electrolyte 74  
 electrolytic protection 171  
 electromotive force 74  
 electron 161  
 electroplate 171  
 electrovalent bond 161  
 element 161  
 elevation 70, 247  
 elevator 80  
 elevator car 81  
 elevator car safety 80  
 elevator pit 80  
 elevator shaft 80  
 ell 26, 199  
 ellipse 110, 111  
 ellipsoid 111  
 elliptical stair 234  
 elliptical surface 220  
 elliptic paraboloid 219  
 elongation 162  
 embattlement 99  
 embedded space 218  
 embedment length 202  
 emboss 182  
 embrasure 99, 159  
 emergency generator 75  
 emergency lighting 91  
 emissivity 112, 119  
 emphasis 54  
 Empire style 133  
 empty-cell process 280  
 enamel 32, 187  
 encased knot 278  
 encante 99  
 encroachment 221  
 end-bearing pile 102  
 end distance 84  
 end grain 278  
 end joint 140  
 endlap 212  
 end-lap joint 141  
 end-nail 82  
 endurance ratio 165  
 endwall 223  
 energy 167  
 energy code 51  
 energy efficiency rating 124  
 enfilade 216  
 engage 59  
 engaged column 266  
 engawa 137  
 engineer 48  
 engineered brick 19  
 engineered grade 282  
 engineering 11  
 engineer's chain 247  
 English bond 20  
 English cross bond 20  
 engrave 182  
 enneastyle 179  
 entablature 179  
 entasis 180  
 enthalpy 120  
 entrained air 42  
 environmental design 10  
 envision 59  
 EPDM 215  
 epicenter 152  
 epinaos 250  
 epoxy mortar 157  
 epoxy resin 193  
 épure 67  
 equal leg angle 172  
 equal loudness contour 229  
 equiangular 109  
 equilateral 109  
 equilateral arch 14  
 equilibrant 97  
 equilibrium 55, 97  
 equilibrium diagram 97  
 equilibrium moisture content 277  
 equinox 226  
 equipole 55  
 equivalent load 151  
 equivalent round 172  
 equivalent thickness 160  
 ER bulb 144  
 erect 49  
 erection bracing 151  
 erection stress 151  
 ergonomics 57  
 escalator 81  
 escarp 98  
 esconson 63  
 escutcheon 116  
 esonarthex 35  
 esquisse 67  
 esthetics 10  
 Etruscan architecture 129  
 Euclidean geometry 108  
 Euclidean space 217  
 Euler buckling load 40  
 eurythmy 56  
 eustyle 179  
 evaluate 58  
 evaluation 58  
 evaporate 161  
 evaporative cooling 120  
 evaporator 124  
 evergreen 276  
 evolute 110  
 excavation 221  
 excelsior 119  
 exedra 35  
 exfoliation 43  
 exhaust air 125  
 exhaust fan 127  
 exhedra 35  
 existing grade 222  
 exit 91  
 exit access 91  
 exit corridor 91  
 exit court 91  
 exit discharge 91  
 exit door 91  
 exit light 91  
 exit passageway 91

- exit stairway 91  
 exonarthex 35  
 expanded clay 43  
 expanded metal 172  
 expanded-metal lath 190  
 expanded plastic 119  
 expanded shale 43  
 expanded slate 43  
 expanded view 71  
 expansion bend 197  
 expansion bolt 84  
 expansion joint 178  
 expansion joint cover 178  
 expansion loop 197  
 expansion screed 190  
 expansion shield 84  
 expansion sleeve 84, 178  
 expansion valve 124  
 expansivity 165  
 exploded view 71  
 explosive rivet 86  
 exposed aggregate finish 47  
 exposed grid 31  
 exposure 212  
 exposure 1 282  
 exposure 2 282  
 exposure condition 154  
 exposure durability 282  
 expression 128  
 extended plenum system 122  
 extended-service lamp 144  
 extensibility 178  
 extension bolt 116  
 extension casement hinge 273  
 extensometer 162  
 exterior 282  
 exterior angle 109  
 exterior exit 91  
 exterior exit balcony 91  
 exterior panel 205  
 exterior plywood 282  
 exterior wall 266  
 external reflected component 150  
 external wall 266  
 extra-strong pipe 172  
 extrados 12  
 extruded polystyrene 119  
 extrusion 169  
 eye 264  
 eyebolt 84  
 eyebrow 209  
 eyelet 99
- Ff**  
 fabric 53  
 fabricate 50  
 facade 24  
 face 98  
 face brick 18  
 face clearance 113  
 faced block 160  
 faced wall 156  
 face glazing 113  
 face-nail 82  
 faceplate 79, 116  
 face putty 113  
 face shell 160  
 face string 235  
 face width 279  
 facing 156  
 facing brick 18  
 factored load 240  
 factored load design 240  
 factor of safety 240  
 factory lumber 279  
 Fahrenheit scale 117  
 fall 200  
 false front 24  
 falsework 49  
 fan 127  
 fan-coil unit 126  
 fancy 59  
 fanlight 63  
 fan truss 261  
 fan vault 263  
 fascia 181, 213  
 fascia board 213  
 fastening 82  
 fastest-mile wind speed 154  
 fast-pin hinge 115  
 fast-track 49  
 fatigue 165  
 fatigue limit 165  
 fatigue ratio 165  
 fat mix 157  
 faucet 197  
 fault 76, 152  
 feasibility study 49  
 feather 140  
 Federal style 133  
 feedback 58  
 feeder 75  
 feint 177  
 female 199  
 fenestration 24  
 ferrocement 202  
 ferroconcrete 202  
 ferrous metal 170  
 ferrule 281  
 Fertile Crescent 128  
 festoon 184  
 fiber 276  
 fiberboard 119, 284  
 fiberboard sheathing 119  
 Fiberglas 119  
 fiberglass 119  
 fiberglass-reinforced concrete 202  
 fiberglass-reinforced plastic 193  
 fiberglass shingle 212  
 fiber-saturation point 277  
 Fibonacci series 56  
 field 155  
 fielded panel 268  
 field of vision 264  
 fieldstone 237  
 field tile 214  
 figure 109, 265, 283  
 figured glass 112  
 figure-ground 265  
 filament 144  
 fillgree 182  
 fill 222  
 filler 192  
 filler metal 86  
 filler plate 174  
 fillet 181, 185  
 filleting 177  
 fillet weld 86  
 fillister head 83  
 film 192  
 filter 125  
 filter fabric 176  
 final prestress 206  
 fine aggregate 43  
 fine grading 222  
 fine texture 278  
 finger joint 140  
 final 37  
 finish coat 187, 188  
 finish floor 92  
 finish flooring 94  
 finish grade 222  
 finish hardware 114  
 finishing 47  
 finishing nail 82  
 finish string 235  
 Fink truss 261  
 fin tube 123  
 fire-alarm system 90  
 fire area 89  
 fire assembly 89  
 firebox 87  
 firebreak 89  
 firebrick 18  
 fire clay 18  
 fire curtain 257  
 firecut 93  
 fire damper 89  
 fire-detection system 90  
 fire door 89  
 fire escape 91  
 fire hazard 88  
 fire hose 90  
 fire hydrant 90  
 fire load 88  
 fireplace 87  
 fireplug 90  
 fireproofing 88  
 fire pump 90  
 fire-rated 88  
 fire-resistance rating 88  
 fire-resistant 88  
 fire-retardant paint 187  
 fire-retardant wood 280  
 fire safety 88  
 fire screen 87  
 fire separation 89  
 firestop 267  
 fire wall 89  
 fire window 89  
 fire zone 89  
 firing 32  
 firmness 11  
 first floor 23  
 fish joint 140

- fishplate 140  
 fixed arch 13  
 fixed connection 242  
 fixed-end beam 17  
 fixed-end connection 242  
 fixed frame 104  
 fixed joint 242  
 fixed light 273  
 fixed sash 273  
 fixture drain 200  
 fixture unit 197  
 Flamboyant style 132  
 flame finish 237  
 flame retardant 88  
 flame-spread rating 88  
 flange 173  
 flange angle 173  
 flank 98  
 flanking path 232  
 flap hinge 115  
 flare header 20  
 flashing 18, 177  
 flash point 88  
 flat 139, 187, 257  
 flat arch 14  
 flat grain 278  
 flat head 83  
 flat-joint pointing 155  
 flat plate 205  
 flat roof 208  
 flat slab 205  
 flat slicing 283  
 flat truss 261  
 flat use factor 280  
 flèche 37  
 Flemish bond 20  
 Flemish cross bond 20  
 Flemish diagonal bond 20  
 fleur-de-lis 184  
 flexible 238  
 flexible duct 122  
 flexible metal conduit 78  
 flexure formula 16  
 filer 234  
 files 257  
 flight 233  
 fitch 283  
 fitch beam 281  
 fitch girder 281  
 fitch plate 281  
 float 47  
 float finish 47, 189  
 float glass 112  
 floating coat 188  
 floating foundation 101  
 float switch 79  
 float valve 198  
 flocked carpet 95  
 flood lamp 147  
 flood level 198  
 floodlight 147  
 floor 23, 92  
 floor anchor 85  
 floor cavity 149  
 floor closer 114  
 floor covering 95  
 floor framing 92  
 flooring nail 82  
 floor plan 69  
 Florentine mosaic 182  
 flowing tracery 275  
 flow pressure 197  
 flow rate 198  
 flue 87  
 flue lining 87  
 fluid 161  
 fluid-applied roofing 215  
 fluid ounce 166  
 fluorescence 145  
 fluorescent lamp 145  
 flush bead 268  
 flush bolt 116  
 flush door 65  
 flush frame 65  
 flush girt 107  
 flush glazing 113  
 flush joint 140, 155  
 flushometer valve 198  
 flush panel 268  
 flute 180  
 fluting 180  
 flutter 154, 230  
 flux 86  
 flux-cored arc welding 86  
 fly ash 42  
 flying buttress 262  
 flying form 45  
 flying shore 221  
 fly loft 257  
 fly rafter 211  
 foamed plastic 119  
 foamed-in-place insulation 119  
 foam glass 119  
 foam rubber 193  
 focus 217  
 focusing 230  
 foil 275  
 foil-backed gypsum board 191  
 folded plate 194  
 folding casement 273  
 folding door 62  
 foliated 184  
 foliation 275  
 folly 27  
 font 35  
 foot 166  
 foot-candle 142  
 foot cut 211  
 footing 100  
 foot-lambert 142  
 footlights 257  
 footpace 234  
 foot-pound 167  
 force 96  
 force arm 96  
 forced warm-air heating 122  
 forecourt 25  
 foreground 265  
 foreshortening 73  
 forge 169  
 form 45, 52, 53  
 form-active structure 238  
 form decking 93  
 formeret 263  
 Formica 193  
 form liner 45  
 form nail 82  
 form tile 45  
 formula weight 161  
 formwork 45  
 fortification 98  
 forum 251  
 foundation 100  
 foundation drain 176  
 foundation investigation 225  
 foundation wall 101  
 Four Noble Truths 253  
 four-pipe system 126  
 four-way switch 79  
 fox bolt 84  
 foxtail wedge 141  
 fox wedge 141  
 foyer 258  
 fractable 159  
 fracture 164  
 frame 104  
 framed connection 174  
 framed tube 245  
 frame house 267  
 frame system 244  
 framework 106  
 framing 106  
 framing anchor 85  
 framing plan 69  
 Franklin stove 121  
 free-body diagram 97  
 free fall 46  
 freehand drawing 66  
 freestone 237  
 freight elevator 80  
 French arch 14  
 French door 64  
 French drain 223  
 French window 273  
 frequency 228  
 fresco 182  
 fresh air 125  
 fresh-air inlet 200  
 Fresnellens 146  
 fret 184  
 frictional damping 245  
 friction pile 102  
 frieze 179, 186  
 frit 32  
 front 27  
 front hearth 87  
 frontispiece 24  
 front of the house 258  
 frost boil 100  
 frost heave 100  
 frostline 100  
 frustum 111  
 fuel-contribution rating 88  
 fulcrum 97  
 full-cell process 280

- full frame 107  
 full-penetration weld 86  
 full-surface hinge 115  
 function 58  
 functional dimension 57  
 functional grouping 216  
 Functionalism 135  
 fundamental 228  
 fundamental frequency 228  
 fundamental period of vibration 152  
 funicular arch 13  
 funicular curve 28  
 funicular polygon 28  
 funicular shape 28  
 funicular structure 28  
 funicular truss 259  
 furnace 121  
 furring 190  
 fuse 76  
 fusible alloy 76  
 fusible link 89  
 fusible metal 76  
 fusion-bonded carpet 95
- Gg**
- gabion 270  
 gable 208  
 gable dormer 209  
 gable roof 208  
 gable wall 266  
 gable window 274  
 gadroon 185  
 gage 172  
 gain 115, 141  
 galilee 37  
 gallery 27  
 gallery 36, 216, 258  
 gallet 158  
 gallon 166  
 galvanic cell 74  
 galvanic corrosion 171  
 galvanic series 171  
 galvanize 171  
 galvanized iron 171  
 gambrel roof 208  
 garden apartment 139  
 garden-wall bond 20  
 wardrobe 99  
 gargyle 37  
 garnet 158  
 garth 37  
 gas 161  
 gas furnace 121  
 gasket 199  
 gas welding 86  
 gate contact 81  
 gate valve 199  
 gathering 122  
 gauge 19, 95, 172, 212  
 aged plaster 188  
 auging plaster 188  
 Gautama Buddha 253  
 azebo 27  
 bulb 144  
 general contractor 48  
 general diffuse lighting 148  
 general lighting 148  
 general purpose circuit 77  
 generator 75, 111, 124  
 generatrix 111  
 geodesic dome 60  
 geometric 52  
 geometrical stair 234  
 Geometric style 132  
 geometric tracery 275  
 geometry 108  
 Georgian architecture 133  
 geotechnical 225  
 geotextile 176  
 gestalt 265  
 Gestalt psychology 265  
 gesture 66  
 gesture drawing 66  
 gfrc 202  
 gib door 64  
 gingerbread 134  
 girder 106  
 girt 107, 269  
 glaciis 98  
 glare 148  
 glass 112  
 glass block 112  
 glass brick 112  
 glass door 64  
 glassed surface 237  
 glass mullion system 113  
 glass size 113  
 glass wool 119  
 glaze 32  
 glaze coat 187  
 glazed wall tile 33  
 glaze-fired 32  
 glazier's point 113  
 glazing 113  
 glazing bar 271  
 glazing bead 113  
 glazing brad 113  
 glazing compound 113  
 glazing size 113  
 glazing stop 113  
 glazing tape 113  
 globe valve 199  
 gloss 187  
 glory 183  
 glued-laminated timber 281  
 glulam 281  
 gneiss 236  
 godroon 185  
 gold bronze 175  
 golden mean 56  
 golden section 56  
 gong 254  
 good grade 283  
 gooseneck lamp 147  
 gopuram 253  
 gorge 98  
 Gothic arch 14  
 Gothic architecture 132  
 Gothic Revival 134  
 government system 246  
 grab bar 198  
 gradation 55  
 grade 222  
 grade beam 101  
 graded aggregate 43  
 grade line 222  
 grademark 280  
 Grade N 160  
 grade stake 222  
 gradestamp 282  
 grade strip 45  
 Grade S 160  
 gradin 256  
 gradine 256  
 grading plan 69  
 graffiti 182  
 graffito 182  
 grain 237, 278  
 gram 167  
 gram calorie 117  
 grand tier 258  
 granite 236  
 granular material 225  
 graphic 73  
 graphic scale 69  
 gravel 224  
 gravel drain 176  
 gravel stop 215  
 gravity 167  
 gravity hinge 115  
 gravity wall 270  
 gravity water system 197  
 gray 39  
 gray scale 38  
 grease interceptor 201  
 grease trap 201  
 great circle 60  
 great hall 99  
 Great Wall of China 129  
 Greek architecture 129  
 Greek cross 183  
 Greek temple 250  
 Greek theater 256  
 green 157  
 Greenfield conduit 78  
 green room 258  
 grid 68, 101, 257  
 gridiron 257  
 grid organization 218  
 grid structure 195  
 griffe 183  
 griffin 183  
 grillage 101  
 grille 122  
 grisaille 66  
 groin 263  
 groin rib 263  
 groin vault 263  
 grommet 78  
 groove weld 86  
 gross cross-sectional area 160  
 grotesque 183  
 ground 76, 190, 265  
 ground acceleration 152  
 ground beam 101

- groundbreaking 221  
 ground coat 187  
 ground color 187  
 grounded conductor 76  
 ground fault 76  
 ground-fault interrupter 76  
 ground floor 23  
 grounding electrode 76  
 grounding outlet 79  
 grounding plug 79  
 ground light 150  
 ground line 72  
 ground plane 72  
 ground slab 101  
 groundwater 223  
 ground wire 76  
 group number 282  
 grout 157  
 grouted frame 65  
 grouted masonry 157  
 grout lift 157  
 grout pour 157  
 growth ring 276  
 gryphon 183  
 gudgeon 115  
 gulde meridian 246  
 gulde rail 80  
 gulloche 184  
 gula 185  
 gulou 254  
 Gunite 46  
 Gunter's chain 247  
 Gupta 130  
 gusset 261  
 gust factor 154  
 gutta 180  
 guttae band 180  
 gutter 209  
 gutter hanger 209  
 guy cable 29  
 gypsum 188  
 gypsum board 191  
 gypsum lath 190  
 gypsum-perlite plaster 188  
 gypsum plaster 188  
 gypsum sheathing 191  
 gypsum-vermiculite plaster 188
- Hh**  
 halden 255  
 half-blind dovetail 141  
 half-lap joint 141  
 half-mortise hinge 115  
 halfpace landing 234  
 half relief 182  
 half round 185  
 half-round sicing 283  
 halfspace landing 234  
 half-surface hinge 115  
 half-timber 107  
 half-turn stair 234  
 hall 216  
 hallway 216  
 halo 183  
 halogen lamp 144  
 halved joint 141  
 hammer beam 210  
 hammer-beam roof 210  
 hammer brace 210  
 hammer post 210  
 hand 114  
 handrail 233  
 handsplit-and-resawn shake 213  
 hanger 85  
 Hanging Gardens of Babylon 129  
 hanging gutter 209  
 hanging step 235  
 hanging stile 64, 272, 273  
 haptic 57  
 Harappa 128  
 hardboard 284  
 hard-burned 32  
 hard finish 188  
 hard light 148  
 hardness 165  
 hard steel 170  
 hardware 188  
 hardware 114  
 hardware cloth 172  
 hard water 197  
 hardwood 276  
 harmonic 228  
 harmonic motion 152  
 harmonic progression 56  
 harmonic series 56  
 harmony 54  
 harped tendon 207  
 hashira 255  
 hatching 66  
 Hather 249  
 Hathoric-headed 249  
 Hathoric 249  
 haunch 12, 17  
 haunched tenon 141  
 head 63, 197, 213  
 header 19, 92  
 header block 160  
 head flashing 271  
 heading course 20  
 head joint 155  
 headlap 212  
 headroom 233  
 headwall 223  
 heal bead 113  
 hearing 229  
 hearing loss 229  
 hearth 87  
 heartwood 276  
 heat 117  
 heat-absorbing glass 112  
 heat capacity 117  
 heat content 120  
 heat exchanger 124  
 heating degree-day 121  
 heating load 121  
 heating medium 121  
 heat of condensation 161  
 heat of fusion 161  
 heat of hydration 47  
 heat of solidification 161  
 heat of vaporization 161  
 heat pump 124  
 heat-resistant paint 187  
 heat sink 124  
 heat-strengthened glass 112  
 heat-treatable alloy 175  
 heat treatment 169  
 heavy-timber construction 51  
 hectare 166  
 heel 259  
 Helan 131  
 height 109  
 height factor 154  
 helicline 233  
 hellodon 150  
 helix 110, 181  
 Hellenic 129  
 Hellenistic 129  
 heptastyle 179  
 hermetic 112  
 herringbone 184  
 herringbone matching 283  
 hertz 228  
 hexagon 109  
 hexagram 183  
 hexahedron 111  
 hexastyle 179  
 hexhead 84  
 hiding power 187  
 HID lamp 145  
 hierarchy 54  
 high altar 37  
 high chair 45  
 high-density overlay 282  
 high gloss 187  
 high-intensity discharge lamp 145  
 high key 66  
 high-lift grouting 157  
 highlight 70, 148  
 high-output lamp 145  
 high polymer 192  
 high-pressure laminate 193  
 high-pressure sodium lamp 145  
 high-range sealant 178  
 high relief 182  
 High Renaissance 133  
 high-rise 22  
 high-strength bolt 174  
 high-strength low-alloy steel 170  
 high-tech 135  
 high-tension bolt 174  
 high-velocity duct 126  
 high-voltage 75  
 Hinduism 253  
 hinge 115  
 hinged frame 104  
 hinge joint 242  
 hinge stile 64  
 hip 209  
 hipjack 211  
 hipped gable 208  
 hipped roof 208  
 hip rafter 211  
 hip roof 208  
 hip tile 214

- history 128  
 Hittite architecture 129  
 hogan 136  
 hoisting cable 80  
 hoisting machinery 80  
 hoistway 80  
 hoistway door 80  
 holddown 85  
 holddown clip 214  
 hollow-backed 94  
 hollow-core door 65  
 hollow-core slab 206  
 hollow masonry unit 160  
 hollow-metal door 65  
 hollow-metal frame 65  
 hollow tile 34  
 hollow unit masonry 157  
 Holy Art 250  
 holy of holies 250  
 homogeneous 54  
 honden 255  
 hondo 255  
 honed finish 237  
 honeycomb 47  
 honeycomb slating 213  
 honeycomb work 252  
 honeysuckle ornament 184  
 hood 87  
 hood mold 274  
 hook 202  
 Hooke's law 164  
 hoop force 60  
 hoop line 60  
 hopper 273  
 hopper light 273  
 hopper window 273  
 horizon 224  
 horizon line 72  
 horizontal 108  
 horizontal circle 247  
 horizontal diaphragm 243  
 horizontal exit 91  
 horizontal force factor 153  
 horizontal furnace 121  
 horizontally sliding window 272  
 horizontal shearing stress 15  
 horizontal torsion 153  
 horn 271  
 horse 189, 235  
 horsed mold 189  
 horsepower 167  
 horseshoe arch 14  
 hose bibb 197  
 hosecock 197  
 hospital light 273  
 hospital stop 65  
 hospital window 273  
 hot 76  
 hot-dip galvanizing 171  
 hot-roll 169  
 hot-rolled finish 169  
 hot-water heating 123  
 hot-working 169  
 house 136  
 house curtain 257  
 housed joint 140  
 house drain 200  
 housed string 235  
 houselights 257  
 house sewer 200  
 house storm drain 223  
 house storm sewer 223  
 house trap 200  
 housing unit 139  
 Howe 261  
 H-pile 102  
 HP-shape 172  
 HPS lamp 145  
 Hsia 128  
 hue 38  
 human engineering 57  
 human scale 56  
 humidifier 125  
 humidity ratio 120  
 hung sash 272  
 hung-span 17  
 hurricane anchor 85  
 hurricane tie 85  
 hut 136  
 HVAC 125  
 hydrant 90  
 hydrated lime 157  
 hydration 47  
 hydraulic cement 42  
 hydraulic elevator 81  
 hydrogen bond 161  
 hydronic heating 123  
 hygrometer 120  
 hypaethral 251  
 Hypalon 215  
 hypar 219  
 hyperbola 110, 111  
 hyperbolic paraboloid 219  
 hyperboloid 220  
 e hypethral 251  
 hypocenter 152  
 hypostyle hall 249  
 hypotenuse 109  
 hypothesis 58  
 hypotrachelum 180  
 hysteresis damping 245  
  
 ii  
 I-beam 173, 281  
 ice dam 212  
 icon 35  
 iconostasis 35  
 icosahedron 111  
 idea 59  
 idle sheave 80  
 IES 150  
 igloo 136  
 igneous rock 236  
 ignition point 88  
 I-joist 281  
 illuminance 142  
 illumination 142  
 image 59, 66  
 imagination 59  
 imbrex 214  
 imbrication 184, 212  
 impact factor 151  
 impact insulation class 232  
 impact load 151  
 impact noise 232  
 impervious soil 225  
 implement 58  
 Impluvium 137  
 importance factor 154  
 impost 12  
 impost block 36  
 inactive leaf 62  
 in-and-out bond 158  
 Inca architecture 132  
 incandescence 144  
 incandescent lamp 144  
 inch 166  
 inch-pound 167  
 incidence 143  
 inclined lift 81  
 increaser 199  
 indeterminate 105  
 Indian architecture 129  
 India rubber 193  
 indirect glare 148  
 indirect lighting 148  
 indirect waste pipe 200  
 individual circuit 77  
 individual vent 200  
 induction unit 126  
 inert gas 161  
 inert gas configuration 161  
 inert-gas shielded arc welding 86  
 inertia 97  
 inertia block 232  
 infiltration 118  
 inflection 58, 110  
 inflection point 17  
 inform 59  
 infrared 142  
 infrared lamp 144  
 inglenook 87  
 ingot 169  
 initial prestress 206  
 initiation 58  
 injection molding 192  
 inlay 182  
 inner bark 276  
 inner hearth 87  
 instant-start lamp 145  
 instrument station 247  
 insulating concrete 43  
 insulating glass 112  
 insulating gypsum lath 190  
 insulator 78  
 insurance 48  
 intaglio 182  
 integrated ceiling 31  
 intensity 38  
 intercepting drain 223  
 intercolumniation 179  
 interdome 61  
 interference 231  
 intergrown knot 278  
 interior angle 109



- Interior design 10  
 Interior panel 205  
 Interior plywood 282  
 Interior wall 266  
 Interlacing arcade 36  
 Interlocking joint 158  
 Interlocking spaces 218  
 Interlocking tile 214  
 Intermediate column 40  
 Intermediate rib 263  
 Intermediate stiffener 173  
 Internal damping 245  
 Internal dormer 274  
 Internal reflected component 150  
 International style 135  
 International System of Units 166  
 Intersecting arcade 36  
 Interstice 218  
 Interstitial 239  
 Intertriglyph 180  
 Interval 55  
 Intonaco 189  
 Intrados 12  
 Intuition 59  
 Intumescent paint 88  
 Inverse-square law 142  
 Inverted tee 206  
 Invisible hinge 115  
 Involute 110  
 Ion 161  
 Ionic bond 161  
 Ionic order 181  
 IR lamp 144  
 Iron 170  
 Irregular grid 239  
 Irregular mass 244  
 Irregular structure 244  
 Islam 131  
 Islamic architecture 131  
 Isobar 102  
 Isocephalic 73  
 Isochart 146  
 Isolated footing 101  
 Isolation joint 178  
 Isolation mount 232  
 Isolux line 146  
 Isometric 71  
 Isometric projection 71  
 Isosceles 109  
 Isostatic plate 194  
 Isostatics 194  
 Isotropic 162  
 Italian Renaissance architecture 132  
 Ivan 252  
 Iwan 252
- Jj**  
 Jack 206, 211  
 Jack arch 14  
 Jacking force 206  
 Jack rafter 211  
 Jalousie 273  
 Jalousie window 273  
 Jamb 63  
 Jamb anchor 65
- Jamb block 160  
 Jambstone 159  
 Japanese architecture 131  
 Japanese lacquer 187  
 J-bolt 84  
 Jerkinhead 208  
 Jerusalem cross 183  
 Jib door 64  
 Joggle 140, 210  
 Joggle piece 210  
 Joggle post 210  
 Joinery 140  
 Joint compound 191  
 Joint filler 178  
 Joint movement 178  
 Joint reinforcement 157  
 Joint sealant 178  
 Joint tape 191  
 Joist 92  
 Joist anchor 85  
 Joist band 204  
 Joist girder 173  
 Joists and planks 279  
 Joist slab 204  
 Joule 167  
 Joule's law 74  
 Judas 114  
 Judas hole 114  
 Judgment 58  
 Jugendstil 134  
 Jumbo brick 19  
 Junction box 78  
 Jutty 107  
 Juxtaposition 54
- Kk**  
 Ka'aba 252  
 Kairo 255  
 Kakemono 137  
 Kalamein door 65  
 Kaolin 32  
 Kasuga-zukuri 255  
 Katsuogi 255  
 K-brace 243  
 Keel 185  
 Keene's cement 188  
 Keep 99  
 Kelvin 117  
 Kelvin scale 117  
 Ken 137  
 Kerf 31  
 Kerfing 186  
 Kern 41  
 Kern area 41  
 Kern point 41  
 Key 66, 116, 141, 189, 263  
 Key course 262  
 Keyed joint 141  
 Keyhole 116  
 Key pattern 184  
 Keystone 12  
 Key switch 79  
 Keyway 45, 116  
 Khmer 253  
 Kibla 252
- Kick plate 114, 235  
 Kiln 18  
 Kiln-dried 277  
 Kilocalorie 117  
 Kilogram 167  
 Kilogram calorie 117  
 Kilometer 166  
 Kilowatt 74  
 Kilowatt-hour 74  
 Kinesthesia 57  
 Kinetic theory of heat 165  
 Kingbolt 261  
 King closer 20  
 King post 210  
 King rod 261  
 King truss 210  
 Kip 167  
 Kite winder 234  
 Kiva 136  
 Knee 105  
 Knee brace 243  
 Kneeler 159  
 Knee wall 211  
 Knife-blade fuse 76  
 Knife switch 79  
 Knitted carpet 95  
 Knob-and-tube wiring 79  
 Knockdown frame 65  
 Knocker 114  
 Knockout 78  
 Knot 278  
 Knuckle 115  
 Kodo 255  
 Kondo 255  
 Koran 252  
 Kraft paper 119  
 Kung 254
- Ll**  
 Label 159  
 Labeled 89  
 Labyrinth 37  
 Lac 187  
 Laced valley 212  
 Lacing 174  
 Lacquer 187  
 Lacunar 30  
 Ladder 233  
 Lady chapel 37  
 Lag 12  
 Lag bolt 83  
 Lagging 221  
 Lag screw 83  
 Laitance 46  
 Lally column 174  
 Lamassu 248  
 Lambert 142  
 Lambert's law 142  
 Lamella 195  
 Lamella roof 195  
 Lamine 193  
 Laminated block 94  
 Laminated glass 112  
 Laminated veneer lumber 284  
 Lamp 144

- lamp base 144  
 lamp diameter 144  
 lamp holder 144  
 lamp lumens depreciation 149  
 lamp socket 144  
 lanai 25  
 lancet arch 14  
 landing 80, 234  
 landing tread 235  
 landscape architecture 11  
 land survey 246  
 lantern 61, 81  
 lap dovetail 141  
 lap joint 141  
 lap siding 268  
 lap splice 203  
 lap weld 86  
 large calorie 117  
 Lascaux Cave 128  
 lat 253  
 latch 116  
 latchbolt 116  
 latent heat 117  
 lateral bracing 41, 243  
 lateral buckling 16  
 lateral load 152  
 lateral reinforcement 203  
 lateral stability 243  
 late wood 276  
 latex 187  
 latex paint 187  
 bath 190  
 Latin cross 183  
 latitude 226  
 lattice 27, 161  
 lattice dome 60  
 latticed truss tube 245  
 lavatory 198  
 law of action and reaction 97  
 law of inertia 97  
 law of reflection 143  
 layer board 209  
 L-beam 206  
 leach 201  
 lead 79, 175  
 leader 68, 122, 209  
 leader head 209  
 lead wedge 177  
 leaf 62, 115  
 lean mix 157  
 lean-to 208  
 lean board 209  
 ledger 267  
 ledger beam 206  
 ledger strip 267  
 leeward 154  
 left-hand 114  
 left-hand reverse 114  
 legal description 246  
 lending institution 48  
 length 166  
 lengthening joint 140  
 lens 146  
 lenticular structure 28  
 Lesbian cyrena 185  
 let in 267  
 letter slot 114  
 level 247  
 leveling 247  
 leveling rod 247  
 lever 97  
 lever handle 116  
 lever operator 273  
 lever tumbler 116  
 lewis 156  
 lewis bolt 84  
 Lexan 192  
 licensed 48  
 lierne 263  
 lift 45, 80  
 liftoff hinge 115  
 lift-slab construction 50  
 lift stage 257  
 light 142, 271  
 light center length 144  
 light frame construction 106  
 light framing 279  
 lighting 148  
 lighting fixture 146  
 light loss factor 149  
 lightness 38  
 lightning arrester 77  
 lightning rod 77  
 light strip 147  
 lightweight block 160  
 lightweight concrete 43  
 light wood frame construction 51  
 lignin 276  
 lime 157  
 lime mortar 157  
 lime plaster 188  
 lime putty 188  
 limestone 236  
 limit design 240  
 limit switch 80  
 line 52, 66, 108  
 linear diffuser 31  
 linear metal ceiling 31  
 linear organization 218  
 linear perspective 72  
 linear source 147  
 linear structure 238  
 line drop 75  
 line of action 96  
 line of thrust 13  
 line of travel 234  
 line voltage 75  
 lingdao 254  
 link dormer 209  
 linked spaces 218  
 linoleum 95  
 lintel 266  
 lintel block 160  
 lip 116  
 liquefaction 153  
 liquid-filled column 88  
 liquid limit 225  
 list 185  
 liter 166  
 live 76, 230  
 live knot 278  
 live load 151  
 liwan 252  
 load 77, 124, 151  
 load balancing 207  
 load-bearing partition 266  
 load-bearing wall 266  
 load combination 151  
 load factor 77  
 load-factor design 240  
 load flow 241  
 load reduction 151  
 load strip 241  
 load trace 241  
 loam 224  
 lobby 258  
 local buckling 259  
 local color 70  
 local lighting 148  
 local symmetry 55  
 lock 116  
 locking handle 273  
 lock nut 84  
 lock rail 64  
 lock seam 214  
 lockset 116  
 lock stile 64  
 lockstrip gasket 113  
 lock washer 84  
 loess 224  
 loft 22, 36  
 loft building 22  
 log 277  
 logarithm 229  
 loge 258  
 loggia 26  
 Lombard architecture 131  
 long-and-short work 158  
 long column 40  
 longhouse 136  
 longitude 226  
 longitudinal reinforcement 203  
 longitudinal section 70  
 longitudinal shrinkage 277  
 long-life lamp 144  
 lookout 211  
 loom 79  
 loophole 99  
 loop pile 95  
 loop vent 200  
 loose-fill insulation 119  
 loose fit 216  
 loose-joint hinge 115  
 loose knot 278  
 loose-pin hinge 115  
 loss of prestress 206  
 lotus 184  
 lotus capital 249  
 loudness 229  
 lounge 258  
 louver 64, 107, 146  
 louvered ceiling 31  
 louvered door 64  
 low-e glass 112  
 low-emissivity glass 112

- low-lift grouting 157  
 low-key 66  
 low-pressure laminate 193  
 low-pressure sodium lamp 145  
 low relief 182  
 low-rise 22  
 lowside window 274  
 low-voltage 77  
 LPS lamp 145  
 L sill 267  
 L stair 234  
 lucarne 61, 274  
 Lucite 192  
 lug sill 271  
 lumber 277  
 lumen 142  
 lumen method 149  
 luminaire 146  
 luminaire dirt depreciation 149  
 luminaire efficiency 146  
 luminance 142  
 luminous ceiling 31  
 luminous flux 142  
 luminous intensity 142  
 lunette 61  
 luthern 274  
 lux 142  
 lychnoscope 274
- Mm**  
 machicolation 99  
 machine beam 80  
 machine bolt 84  
 machine burr 278  
 machine rating 280  
 machine room 81  
 machine screw 83  
 machine stress-rating 280  
 made ground 222  
 madrasah 252  
 Magen David 28  
 magnesium 175  
 magnetic north 246  
 maldan 252  
 mall slot 114  
 main 122, 197  
 main member 241  
 main runner 31  
 maintenance factor 149  
 major axis 110  
 maksoorah 252  
 malachite 236  
 male 199  
 malleable 170  
 malleable cast iron 170  
 Maltese cross 183  
 mandapa 253  
 mandira 253  
 mandorla 183  
 mandrel 103  
 manganese 175  
 manganese bronze 175  
 manhole 223  
 manifold 122  
 Mannerism 133  
 mansard 208  
 mansard roof 208  
 mantel 87  
 mantelpiece 87  
 manteltree 87  
 marble 236  
 margin 212  
 marigold window 36  
 marine varnish 187  
 marquee 258  
 mascarón 183  
 mashrebeeyeh 274  
 masjid 252  
 mask 183  
 Masonite 284  
 masonry 155  
 masonry arch 12  
 masonry cement 157  
 masonry nail 82  
 mass 67, 167, 217  
 massing 52  
 mast 29  
 mastaba 249  
 Masterformat 50  
 mastic 95, 176  
 mat 101  
 matched lumber 279  
 matching 283  
 material 161  
 matter 161  
 Maurya 129  
 maximum demand 77  
 maximum overall length 144  
 Maxwell diagram 260  
 Mayan architecture 130  
 meander 184  
 mean radiant temperature 120  
 means of egress 91  
 measure 166  
 measuring point 73  
 Mecca 252  
 mechanical bond 190  
 mechanical drawing 68  
 mechanical equipment room 125  
 mechanical equivalent of heat 167  
 mechanical property 162  
 mechanical scale 56  
 mechanical system 121  
 mechanical ventilation 127  
 mechanics 97  
 medallion 183  
 mediating space 218  
 Medieval architecture 130  
 medium-density overlay 282  
 medium-range sealant 178  
 medium steel 170  
 meeting rail 272  
 meeting stile 64, 273  
 megalith 248  
 megaron 250  
 melon 252  
 melamine resin 193  
 melon dome 252  
 membrane 168  
 membrane stresses 219  
 menhir 248  
 mercury lamp 145  
 mercury switch 79  
 mercury-vapor lamp 145  
 merge 27  
 meridian 226  
 meridional force 60  
 meridional line 60  
 merlon 99  
 mesa 136  
 mesh 172  
 meshrebeeyeh 274  
 Mesoamerica 130  
 Mesopotamia 128  
 metal 169  
 metal decking 93  
 metal lath 190  
 metallic bond 161  
 metal pan 31  
 metamorphic rock 236  
 metaphor 59  
 meter 166  
 metes and bounds 246  
 metes-and-bounds survey 246  
 method of joints 260  
 method of sections 260  
 metope 180  
 metric sabin 231  
 metric system 166  
 metric ton 167  
 mew 139  
 meydan 252  
 mezzanine 23, 258  
 mezzo-relievo 182  
 Microlam 284  
 micrometer 166  
 micron 166  
 micropascal 229  
 Middle Ages 130  
 middle strip 204  
 middle-third rule 41  
 mid-rise 22  
 mihrab 252  
 mil 166  
 mildew 176  
 mild steel 170  
 mile 166  
 mill construction 51  
 mill finish 169  
 milliliter 166  
 millimeter 166  
 mill scale 169  
 mimbar 252  
 minaret 252  
 mineral-insulated cable 78  
 mineral spirits 187  
 mineral wool 119  
 Minoan architecture 128  
 minor axis 110  
 minster 132  
 minute 108  
 miscellaneous channel 172  
 Mission Style 134  
 mission tile 214  
 mist coat 187

- miter 140
- miter dovetail 141
- mitered halving 141
- miter joint 140
- mix design 44
- mixed grain 278
- mixer 197
- mixing box 126
- mixing faucet 197
- mixing ratio 120
- mixing valve 199
- mixing water 43
- Mixtec architecture 131
- moat 99
- Moché 129
- Mochica 129
- mock-up 58
- model 58, 59
- model code 51
- modeling 66
- modernism 135
- Modernismo 134
- modify 58
- modillion 181
- modular brick 19
- modular coordination 50
- modular design 50
- module 50, 56
- modulus of elasticity 164
- modulus of rigidity 163
- modulus of torsion 163
- Mogen David 183
- Mogul architecture 133
- Mohammed 131, 252
- Mohs' scale 165
- moisture content 277
- moisture expansion 165
- moisture protection 176
- mold 169, 185
- molded insulation 199
- molded polystyrene 119
- molding 185
- molding plaster 189
- mole 161
- molecular weight 161
- molecule 161
- Molly 84
- moment 96
- moment arm 96
- moment center 96
- moment connection 174
- moment diagram 17
- moment distribution method 105
- moment of inertia 16
- moment-resisting frame 104, 244
- Monel metal 214
- monochromatic 39
- monolith 248
- monolithic terrazzo 94
- monomer 192
- monopteron 251
- monotony 54
- Moor 131
- Moorish arch 14
- Moorish architecture 131
- mopboard 186
- mortar 157
- mortise 141
- mortise-and-tenon joint 141
- mortise hinge 115
- mortise joint 141
- mortise lock 116
- mortuary temple 249
- mosaic 182
- Moslem 252
- mosque 252
- motif 184
- motte 98
- motte and bailey 98
- mouchette 275
- moulding 185
- movable partition 266
- movement 55, 66
- moving load 151
- moving sidewalk 81
- moving staircase 81
- moving stairway 81
- Mozarabic style 131
- MR bulb 144
- M-shape 172
- Mudéjar 132
- Mudéjar architecture 132
- mud sill 267
- Muhammad 131
- Muhammadanism 131
- mullion 62, 268, 271
- multibay frame 105
- multifamily 139
- multifoil 275
- multi-outlet assembly 78
- multistory frame 105
- multizone system 126
- Munself System 38
- muntin 64, 271
- Muntz metal 175
- muqarna 252
- mural 182
- mushroom construction 205
- musjid 252
- Muslim 252
- Muslim architecture 131
- mutule 180
- Mycenaean architecture 129
- Mylar 193
  
- Nn**
- Nagare-zukuri 255
- nail 82
- nailing strip 82
- nandaimon 255
- nanometer 142
- naos 250
- Nara 131
- narthex 35
- natural cement 42
- natural grade 222
- natural period of vibration 152
- natural rubber 193
- natural ventilation 127
- nautical mile 166
- naval brass 175
- nave 35
- neat plaster 188
- necessarium 99
- neck 84
- necking 180
- necropolis 249
- needle 222
- needle beam 222
- needlepunched carpet 95
- negative friction 102
- negative ion 161
- negative moment 17
- negative shear 17
- Neo-Babylonian architecture 129
- Neoclassicism 133
- Neolithic 128
- neon lamp 145
- neoprene 193
- net cross-sectional area 160
- net structure 168
- net tracery 275
- neutral 76
- neutral axis 15
- neutron 161
- newel 81, 234, 235
- newel cap 235
- newel drop 235
- newel post 235
- New Kingdom 249
- newton 167
- newton-meter 167
- Newton's first law of motion 97
- Newton's second law of motion 97
- Newton's third law of motion 97
- N-grade 282
- nickel 175
- nimbus 183
- nipple 199
- noble gas 161
- noble metal 171
- node 259
- nog 107
- nogging 107
- noise 231
- noise criteria curve 231
- noise reduction 231
- noise reduction coefficient 231
- nominal dimension 19, 277
- nominal size 277
- nonbearing partition 266
- nonbearing wall 266
- noncombustible construction 51
- nonconcurrent forces 96
- nonconforming 51
- nonferrous metal 175
- non-heat-treatable alloy 175
- non-load-bearing partition 266
- non-load-bearing wall 266
- nonmetallic sheathed cable 78
- nonobjective 52
- nonparallel system 244
- non-pressure-treated wood 280
- nonrecoverable light loss factor 149
- nonrepresentational 52

- nonstaining mortar 157  
 nonvitreous 32  
 normal force method 154  
 normal stress 162  
 Norman architecture 131  
 Norman brick 19  
 Norman Conquest 131  
 north arrow 69  
 Norwegian brick 19  
 nosing 233, 262  
 notice to proceed 49  
 novelty siding 268  
 nut 84  
 nylon 192
- Oo**  
 obelisk 249  
 object line 68  
 oblate 111  
 oblate spheroid 111  
 oblique 71, 108  
 oblique projection 71  
 oblique section 70  
 obscure glass 112  
 obsidian 236  
 obtuse 109  
 obtuse angle 108  
 occupancy load 151  
 occupancy separation 89  
 occupant load 91  
 octagon 109  
 octahedron 111  
 octastyle 179  
 octave 228  
 oculus 61  
 oeil-de-boeuf 274  
 off-center 110  
 offset bend 203  
 ogee 185  
 ogee arch 14  
 ogive 263  
 ohm 74  
 Ohm's law 74  
 oil-borne preservative 280  
 oil-canning 214  
 oil furnace 121  
 oillet 99  
 oil of turpentine 187  
 oil paint 187  
 oil stain 187  
 oil varnish 187  
 olfactory 57  
 olive hinge 115  
 olive knuckle hinge 115  
 Olmec architecture 129  
 on center 267  
 one-point perspective 73  
 one-sheet hyperboloid 220  
 one-way 238  
 one-way slab 204  
 onion dome 36  
 oolite 236  
 opaque 143  
 opaque stain 187  
 open boarding 213  
 open cornice 213  
 open eaves 213  
 open-end block 160  
 open grain 278  
 opening leaf 62  
 open mortise 141  
 open plan 216  
 open riser 235  
 open-riser stair 235  
 open slating 213  
 open string 235  
 open-string stair 235  
 open-timbered 107  
 open valley 212  
 open-web steel joist 173  
 openwork 182  
 opera house 258  
 operable window 273  
 opisthodomos 250  
 opposition 54  
 optical illusion 264  
 optical mixing 38  
 optical plummet 247  
 optimum moisture content 225  
 opus Alexandrinum 182  
 opus sectile 182  
 opus vermiculatum 182  
 orchestra 256, 258  
 orchestra pit 257  
 orchestra shell 257  
 order 12, 54  
 ordinary construction 51  
 ordinate 108  
 organic 52  
 Organic architecture 135  
 organic soil 224  
 organization 53  
 oriel 274  
 orientation 27, 264  
 oriented strandboard 284  
 originality 59  
 ornament 182  
 orthogonal projection 69  
 orthographic projection 69  
 oscillate 152  
 oscillation 152  
 Osirian column 249  
 Ottoman architecture 132  
 Ottonian architecture 131  
 oulette 99  
 outer hearth 87  
 outlet 79  
 outlet box 79  
 outline 66  
 outlook 217  
 outrigger 211  
 outside air 125  
 outwork 98  
 oval head 83  
 oven-dry 277  
 overburden 221  
 overcast sky 150  
 overcloak 214  
 overdoor 63  
 overflow 198  
 overhanging beam 17  
 overhead concealed closer 114  
 overhead door 62  
 overreinforced section 202  
 overturning moment 153  
 ovolo 185  
 owner 48  
 oxeve 274  
 oxidation 171  
 oxide 171  
 oyelet 99
- Pp**  
 pace 234  
 packaged air conditioner 124  
 pagoda 254  
 pal-lou 254  
 paint 187  
 paint system 187  
 palazzo 26  
 pale 38, 98  
 pallsade 98  
 Palladiana 94  
 Palladian motif 274  
 Pallava 130  
 palm capital 249  
 palmette 184  
 pan 204  
 pan-and-roll tiling 214  
 pane 271  
 panel 50, 64, 76, 204, 259, 268  
 panelboard 76  
 panel clip 212  
 panel grade 282  
 paneled door 64  
 panel heating 123  
 paneling 268  
 panel length 259  
 panel load 259  
 panel point 259  
 panel strip 204  
 panel system 269  
 panel wall 156  
 panhead 83  
 panic bar 116  
 panic bolt 116  
 panic hardware 116  
 pantheon 251, 253  
 pantile 214  
 pan tread 235  
 paper-backed lath 190  
 parabola 110, 111  
 parabolic reflector 146  
 parabolic surface 220  
 paraboloid 219  
 paradise 37  
 parallel drawing 71  
 Parallax 284  
 parallax 264  
 parallel 74, 108  
 parallel-chord truss 261  
 parallel forces 96  
 parallelogram 109  
 parallelogram law 96  
 parallel strand lumber 284

- parapet 98, 266  
 parapet skirting 177  
 parascaenum 256  
 PAR bulb 144  
 parge 87, 176, 189  
 pargeing 87, 189  
 paring 176  
 parliament hinge 115  
 parados 256  
 parquet 94  
 parquet circle 258  
 parquetry 94  
 parterre 27, 258  
 Parthian architecture 129  
 parti 53  
 partial-penetration weld 86  
 partial prestressing 206  
 particleboard 284  
 particle-size distribution 43  
 parting bead 272  
 parting compound 45  
 parting strip 272  
 partition 266  
 partition block 160  
 party wall 266  
 pascal 167  
 passage 67  
 passage grave 248  
 passenger elevator 80  
 passing 177  
 passive earth pressure 100  
 passive solar-heating 227  
 pass-through 274  
 pastiche 183  
 Paternoster 185  
 path 218  
 patina 175  
 patio 26  
 pattern 53, 265  
 patterned glass 112  
 patterned lumber 279  
 paumelle 115  
 pavement saw 47  
 paver tile 33  
 pavilion 24, 27  
 pavilion roof 208  
 P-delta effect 41  
 pea gravel 224  
 peanut gallery 258  
 perlite 43  
 pearl molding 185  
 pebble 224  
 pebble dash 189  
 pecky 278  
 pedestal 179  
 pedestal pile 103  
 pediment 250  
 Peg-Board 284  
 pendant 147, 263  
 pendant post 210  
 pendentive 61  
 pendentive bracketing 252  
 pendentive dome 61  
 penetrating stain 187  
 penetration resistance 225  
 penetration test 225  
 penny 82  
 pent 208  
 pentagon 109  
 pentastyle 179  
 penthouse 80, 139, 208  
 pentice 208  
 people mover 81  
 percentage reinforcement 202  
 perception 265  
 perched water table 223  
 percolation test 201  
 perforated gypsum lath 190  
 perforated shell tube 245  
 perforated tracery 275  
 performance specification 50  
 pergellisol 224  
 pergola 27  
 perimeter heating 122  
 perimeter loop system 122  
 perimeter radial system 122  
 period 152  
 periodic motion 152  
 periodic table 161  
 peripteral 251  
 peristyle 137  
 perlite 43  
 perm 176  
 permafrost 224  
 permanent set 164  
 permeability 225  
 permeance 176  
 perpend 158  
 Perpendicular style 132  
 perpendicular tracery 275  
 Persian 129  
 Persian architecture 129  
 personal distance 57  
 personal space 57  
 perspective 59, 72, 73  
 perspective projection 72  
 pervious soil 225  
 petcock 123  
 phantom 71  
 phantom line 71  
 pharaoh 249  
 phase 58, 76, 228  
 phenolic resin 193  
 phenoplast 193  
 Phillips head 83  
 phloem 276  
 phon 229  
 phosphor 145  
 phosphor bronze 175  
 photochemical 187  
 pi 110  
 piano hinge 115  
 piano nobile 26  
 piazza 27  
 pickle 171  
 pictograph 182  
 pictorial space 72  
 picture mold 186  
 picture plane 72  
 picture rail 186  
 picture window 274  
 plend 185  
 pler 103, 266  
 plg 170  
 pig iron 170  
 pigment 187  
 pigmented stain 187  
 pigtail 79  
 pilaster 266  
 pilaster block 160  
 pile 95, 102  
 pile cap 103  
 pile density 95  
 pile driver 102  
 pile eccentricity 102  
 pile foundation 102  
 pile ring 102  
 pile tolerance 102  
 pile weight 95  
 pillar 40  
 pilot hole 83  
 pilot 26  
 pin 242  
 pin joint 242  
 pinned connection 242  
 pint 166  
 pinnacle 262  
 pintle 115  
 pipe 199  
 pipe batten 257  
 pipe column 174  
 pipe fitting 199  
 pipe pile 102  
 pisay 34  
 pisé 34  
 pisé de terre 34  
 pitch 83, 95, 208, 228, 276  
 pitched roof 208  
 pitched truss 261  
 pitch-faced 237  
 pitching piece 235  
 pitch pocket 278  
 pit dwelling 136  
 pith 276  
 pivoted door 62  
 pivoted window 273  
 place 217  
 placement 46  
 place of beginning 246  
 plafond 30  
 plain lap 141  
 plain rail 272  
 plain-saw 278  
 plain slicing 283  
 plan 69  
 plane 109  
 plane geometry 109  
 plane survey 246  
 plane truss 259  
 plank-and-beam construction 106  
 plank flooring 94  
 plank house 136  
 plant 186  
 planted stop 63  
 plan view 69

- plaster 188  
 plasterboard 191  
 plaster bond 190  
 plasterer's putty 188  
 plaster of Paris 188  
 plastic 192  
 plastic deformation 164  
 plastic flow 164  
 plastic foam 119  
 plastic hinge 104  
 plasticity index 225  
 plasticizer 157, 192  
 plastic laminate 193  
 plastic limit 225  
 plastic mix 44  
 plastic range 164  
 plastic soil 225  
 plat 246  
 plate 152, 172, 194, 267  
 plate action 194  
 plate cut 211  
 plate girder 173  
 plate glass 112  
 plate rail 186  
 plate tracery 275  
 plate tread 235  
 platform frame 267  
 Platonic solid 111  
 plaza 27  
 plenum 31, 122  
 plenum barrier 232  
 plenum chamber 127  
 plenum ventilation 127  
 Plexiglas 192  
 plinth 159, 179, 186  
 plinth block 186  
 plinth course 159  
 plot plan 69  
 plug 79, 199  
 plug fuse 76  
 plumb 211  
 plumbing 196  
 plumbing fixture 198  
 plumbing wall 199  
 plywood 282  
 pneumatic placement 46  
 pneumatic riveter 86  
 pneumatic structure 168  
 pneumatic water supply 197  
 poché 69  
 pocket door 62  
 pocket piece 272  
 podium 250, 256  
 point 54, 108, 155  
 point-bearing pile 102  
 pointed arch 14  
 point method 149  
 point of refusal 102  
 point of resistance 102  
 point of support 242  
 point source 147  
 Poisson's ratio 162  
 polar angle 108  
 polar axis 108  
 polar coordinate system 108  
 polarized 79  
 pole 106  
 pole construction 106  
 pole house 106  
 pole plate 210  
 polished work 237  
 polycarbonate 192  
 polychromatic 39  
 polyester 193  
 polyethylene 192  
 polygon 109  
 polygon method 96  
 polyhedron 111  
 polymer 192  
 polymerization 192  
 polypropylene 192  
 polystyrene 192  
 polythene 192  
 polyurethane 193  
 polyurethane foam 119  
 polyurethane varnish 187  
 polyvinyl butyral 192  
 polyvinyl chloride 192  
 polyvinyl resin 192  
 pony wall 267  
 porcelain 32  
 porcelain enamel 32  
 porch 25  
 pore 276  
 portal 25, 105  
 portal method 105  
 portcullis 99  
 porte-cochère 25  
 portico 25  
 portland cement 42  
 portland cement mortar 33  
 portland cement-lime stucco 189  
 portland cement stucco 189  
 positive ion 161  
 positive moment 17  
 positive shear 17  
 post 40  
 post-and-beam construction 106  
 post-and-lintel construction 106  
 post base 85  
 post cap 85  
 Postclassic 132  
 postern 25, 99  
 postforming 193  
 postiche 183  
 posticum 250  
 post-modernism 135  
 postoccupancy evaluation 49  
 posts and timbers 279  
 posttension 207  
 potable water 196  
 potential 74  
 potential difference 74  
 pound 167  
 power 74, 167  
 power trowel 47  
 pozzolan 42  
 practice 59  
 Prairie School 138  
 Pratt 261  
 preaction system 90  
 precast concrete 206  
 precast concrete pile 102  
 Preclassic 128  
 Pre-Columbian 130  
 prefabricate 50  
 prefabricated flue 87  
 preferred angle 233  
 prefinished gypsum board 191  
 preheat lamp 145  
 preheater 125  
 prehistoric 128  
 prehung door 65  
 premium grade 283  
 preparation 58  
 pre-posttension 207  
 presbytery 37  
 presentation drawing 67  
 preservative 280  
 pressure 167  
 pressure bulb 102  
 pressure coefficient 154  
 pressure drop 197  
 pressure-equalized design 177  
 pressure forming 192  
 pressure head 197  
 pressure-treated wood 280  
 prestress 206  
 prestressed concrete 206  
 pretension 206  
 primary air 126  
 primary beam 106  
 primary cable 29  
 primary color 39  
 primary compression 100  
 primary consolidation 100  
 primary member 241  
 prime coat 187  
 primer 178, 187  
 principal 210  
 principal beam 106  
 principal meridian 246  
 principal rafter 210  
 principal reinforcement 204  
 principal stresses 16  
 principle 59  
 prism 111  
 prismatic lens 146  
 process 58  
 profile 66, 185, 247  
 program 58  
 project 59  
 projected area method 154  
 projected window 273  
 projection 69, 265  
 projet 59  
 prolate 111  
 prolate spheroid 111  
 promenade 27  
 promenade tile 33  
 pronaos 250  
 proof stress 164  
 property 162  
 property line 221  
 proportion 56

proportional limits 164  
 proposal 58  
 proprietary specification 50  
 propylon 249  
 proscenium 256  
 proscenium arch 256  
 prospect 217  
 prostyle 251  
 protected membrane roof 215  
 protected noncombustible construction 51  
 protected opening 89  
 protected ordinary construction 51  
 protected light frame construction 51  
 prosthesis 35  
 proton 161  
 proton number 161  
 prototype 59  
 proxemics 57  
 proximity 54, 265  
 PS bulb 144  
 pseudodipteral 251  
 pseudoperipteral 251  
 psychrometer 120  
 psychrometric chart 120  
 pteroma 251  
 pteron 251  
 public way 91  
 puddle weld 86  
 pueblo 136  
 pull bar 114  
 pulley stile 272  
 pump 125  
 punching shear 205  
 purfle 184  
 purlin 210  
 purpose 58  
 push plate 114  
 putty 113  
 pycnostyle 179  
 pylon 249  
 pyramid 111, 249, 252  
 Pythagorean theorem 109

**Qq**

qibla 252  
 Qin 129  
 quadrangle 27  
 quadrant 110  
 quadrilateral 109  
 quadripartite vault 263  
 quarry-faced 237  
 quarry tile 33  
 quart 166  
 quarterpace landing 234  
 quarter round 185  
 quartersaw 278  
 quarter string 283  
 quarterspace landing 234  
 quarter-turn stair 234  
 quartz heater 123  
 quartzite 236  
 quartz lamp 144  
 quatrefoil 275  
 Quattrocento architecture 132  
 queen closer 20

queen post 210  
 queen truss 210  
 quench 169  
 Quetzalcoatl 131  
 quicklime 157  
 quirk 140, 268  
 quoin 158

**Rr**

rabbet 140  
 rabbeted stop 63  
 rabbet joint 140  
 raceway 78  
 racking 243  
 radial dome 60  
 radial organization 218  
 radial shrinkage 277  
 radial symmetry 55  
 radian 108  
 radiant heat 120  
 radiant heating 123  
 radiation 118  
 radiator 123  
 radius 110  
 radius of gyration 40  
 radius vector 108  
 raft 101  
 rafter 211  
 rafter tail 213  
 rail 64  
 railing 235  
 rainbow roof 208  
 rainscreen 177  
 rainscreen principle 177  
 raised-chord truss 261  
 raised flooring system 93  
 raised girt 107  
 raised grain 278  
 raised panel 268  
 raising plate 267  
 rake 209, 268  
 raked joint 155  
 raker 221  
 rake tile 214  
 raking riser 233  
 raking shore 221  
 rambler 138  
 rammed earth 34  
 ramp 233, 235  
 rampant arch 14  
 rampant vault 263  
 rampart 98  
 random ashlar 158  
 random matching 283  
 random rubble 158  
 random shingles 213  
 random slates 213  
 range 155, 246  
 range line 246  
 ranger 45  
 rapid-start lamp 145  
 rated life 144  
 rath 253  
 ratio 56  
 Rationalism 134

ravelin 98  
 raw water 196  
 ray 276  
 Rayonnant style 132  
 R bulb 144  
 reactive force 97  
 ready-mixed concrete 46  
 ready-mixed plaster 188  
 real 59  
 reason 59  
 rebar 202  
 rebate 140  
 receding color 39  
 receptor 198  
 recessed grid 31  
 recharge 223  
 recoverable light loss factor 149  
 rectangle 109  
 rectangular 109  
 rectangular coordinate system 108  
 rectangular system 246  
 rectilinear 109  
 Rectilinear style 132  
 rectilinear tracery 275  
 red brass 175  
 red label 213  
 reducer 199  
 reduction 175  
 reduction of area 162  
 redundancy 105  
 reeding 185  
 reentrant 109  
 reentrant corner 244  
 reevaluation 58  
 reference specification 50  
 referential drawing 67  
 refine 58  
 reflectance 143  
 reflected ceiling plan 69  
 reflected color 38  
 reflected glare 148  
 reflected plan 69  
 reflected sound 230  
 reflecting surface 230  
 reflection 143  
 reflective glass 112  
 reflective insulation 119  
 reflector 146  
 refraction 143  
 refractory 18  
 refrigerant 124  
 refuge 217  
 Regency style 133  
 register 122  
 registered 48  
 reglet 177  
 regula 180  
 regular 54, 109, 111  
 regular bevel 116  
 regular grid 239  
 regular structure 244  
 regulating line 66  
 reheat coil 126  
 reinforced concrete 202  
 reinforced concrete beam 203



- reinforced concrete column 203  
 reinforced concrete slab 204  
 reinforced grouted masonry 157  
 reinforced hollow-unit masonry 157  
 reinforcement 202  
 reinforcing bar 202  
 reinforcing edge cable 168  
 relative humidity 120  
 release agent 45  
 relief 70, 182  
 relief valve 123  
 relief vent 200  
 relieving arch 266  
 Renaissance 132  
 Renaissance architecture 132  
 rendering 67  
 rendering coat 189  
 repetition 55  
 repetitive member 280  
 repetitive member factor 280  
 repose 54, 217  
 reproductive imagination 59  
 reservoir 196  
 residual stress 169  
 resilient channel 232  
 resilient clip 232  
 resilient flooring 95  
 resilient mounting 232  
 resin 192, 276  
 resin canal 276  
 resin duct 276  
 resinous matrix 94  
 resistance 74  
 resistance welding 86  
 resisting moment 15  
 resistivity 74  
 resonance 152, 230  
 respond 36  
 restoring moment 153  
 restrictive covenant 51  
 resultant 96  
 retaining wall 270  
 retarder 43  
 reticulate 184  
 reticulated tracery 275  
 retrochoir 37  
 return 186  
 return air 125  
 return bend 199  
 return-corner block 160  
 return grille 122  
 return pipe 126  
 return wall 266  
 reveal 63  
 revert 200  
 reverberation 230  
 reverberation time 230  
 reverse bevel 116  
 reverse return 123  
 reverse-trap 198  
 reversible lock 116  
 revet 270  
 revetment 270  
 revolving door 62  
 rheostat 79  
 rhythm 55  
 rib 263  
 ribband 267  
 ribbed mat 101  
 ribbed slab 204  
 ribbed vault 263  
 ribbon 267  
 ribbon strip 267  
 ribbon course 212  
 ribbon window 274  
 rib lath 190  
 rib vault 263  
 rich mix 157  
 Richardsonian Romanesque 134  
 ridge 209  
 ridge beam 211  
 ridge board 211  
 ridge cap 212  
 ridge course 212  
 ridged baffle 146  
 ridgepiece 211  
 ridgepole 211  
 ridge rib 263  
 ridge roll 214  
 ridge tile 214  
 rift cutting 283  
 right angle 108  
 right circular cone 111  
 right circular cylinder 111  
 right-hand 114  
 right-hand reverse 114  
 righting moment 153  
 right triangle 109  
 rigid 238  
 rigid arch 13  
 rigid board insulation 119  
 rigid connection 242  
 rigid frame 104  
 rigid joint 242  
 rigid metal conduit 78  
 rim joist 92  
 rim lock 116  
 ring-shank nail 82  
 rip 278  
 riprap 270  
 ripsaw 278  
 rise 12, 80, 208, 233  
 riser 197, 233  
 riser-tread ratio 233  
 rising hinge 115  
 rivet 86  
 rivet set 86  
 rivaq 252  
 rock 236  
 rock calisson 103  
 rock-cut tomb 249  
 rock-faced 237  
 rock lath 190  
 Rockwell number 165  
 rock wool 119  
 Rococo 133  
 rod 166, 247  
 rodding 46  
 roiled glass 112  
 roller joint 242  
 roller support 242  
 rolling door 62  
 rollock 19  
 roll roofing 215  
 roll seam 214  
 Roman arch 14  
 Roman architecture 130  
 Roman brick 19  
 Romanesque architecture 131  
 Roman theater 256  
 Rome 130  
 Romex cable 78  
 rood 37  
 rood screen 37  
 roof 208  
 roof drain 209  
 roof flange 177  
 roof framing 211  
 roofing 212  
 roofing bond 215  
 roofing felt 215  
 roofing nail 82  
 roofing paper 215  
 roofing tile 214  
 roof plan 69  
 room 216  
 room acoustics 230  
 room cavity 149  
 room cavity ratio 149  
 room surface dirt depreciation 149  
 root 86, 141  
 rose 116, 184  
 rose window 37  
 rosette 184  
 rotary cutting 283  
 rotation 97  
 rotational surface 220  
 roto operator 273  
 rotunda 26  
 rough buck 63  
 roughcast 189  
 rough coat 189  
 rough floor 92  
 rough grading 222  
 rough hardware 114  
 roughing-in 199  
 rough lumber 277  
 rough opening 63  
 rough stringer 235  
 round arch 14  
 round head 83  
 round point 82  
 rout 140  
 row house 139  
 rowlock 19  
 row spacing 84  
 rubber 193  
 rubber-base paint 187  
 rubber tile 95  
 rubble 158  
 ruled surface 220  
 run 208, 233  
 Rundbogenstil 134  
 rung 233  
 running bond 20

# INDEX

- running mold 189  
runoff 223  
runway 258  
rustic 158  
rustication 158  
rustication strip 45  
rustic joint 158  
rustic siding 268  
rustic slates 213  
rustic terrazzo 94  
rust-inhibiting paint 187  
R-value 118
- Ss**
- sabin 231  
sack 44  
sacred 248  
sacrificial anode 171  
sacristy 35  
saddle 63, 209  
saddlebacked coping 266  
saddle coping 266  
saddle joint 159  
saddle surface 219  
safety curtain 257  
safety factor 240  
safety glass 112  
safety nosing 235  
safety tread 235  
safety valve 123  
sailing 269  
sag 28  
sahn 252  
sailor 19  
salient 54, 109  
sally port 98  
saltbox 138  
sanctuary 35  
sanctum sanctorum 250  
sand 224  
sand clay 224  
sand-cushion terrazzo 94  
sand filter 201  
sand-float finish 189  
sand-lime brick 160  
sand pile 103  
sandstone 236  
sand-struck brick 18  
sandwich beam 281  
sandwich panel 50  
sanitary base 33  
sanitary cross 199  
sanitary sewer 200  
sanitary stop 65  
sanitary tee 199  
sanitary ware 198  
sap 276  
sapwood 276  
sarcophagus 35  
sash 271  
sash balance 272  
sash bar 271  
sash block 160  
sash chain 272  
sash cord 272  
sash fast 272  
sash fastener 272  
sash line 272  
sash ribbon 272  
sash stop 272  
sash weight 272  
Sassanian architecture 130  
satin finish 187  
saturated air 176  
saturation 38  
saturation coefficient 18  
saucer dome 60  
sawtooth roof 208  
S bulb 144  
scaffold 49  
scaffold nail 82  
scagliola 189  
scale 56, 69, 166, 169  
scalene 109  
scaling 47  
scallop 184  
scarce ment 159  
scarf joint 140  
scarp 98  
scheme 59  
Schwedler dome 60  
science 11  
scissors truss 261  
sconce 147  
sconcheon 63  
scored block 160  
scotta 181  
SCR brick 19  
scratch coat 188  
screed 47, 190  
screen 266, 274  
screen block 160  
screen door 64  
screw 83  
screw eye 83  
screw nail 82  
scribbling 66  
scribed joint 140  
scrim 190  
scroll 184  
scum 201  
scum clear space 201  
sconcheon 63  
scupper 209  
scutcheon 116  
seal 68  
sealer 187  
seasoned 277  
seat 199  
seat angle 174  
seat cut 211  
seated connection 174  
seating 257  
secant 109  
second 108  
secondary beam 106  
secondary cable 29  
secondary color 39  
secondary consolidation 100  
secondary member 241  
secondary stresses 259  
secret dovetail 141  
section 70, 246  
section line 70  
section modulus 16  
sector 110  
secular 248  
security glass 112  
sedimentary rock 236  
see 264  
seepage pit 201  
segmental arch 14  
segregation 46  
seismic 152  
seismic coefficient 153  
seismic force 152  
seismic joint 244  
seismic zone factor 153  
select 58  
selective absorption 38  
self-centering lath 190  
self-closing fire assembly 89  
self-furring lath 190  
self-tapping screw 83  
Seljuk architecture 132  
selvage 116, 215  
semicircular dome 60  
semidetached dwelling 138  
semidirect lighting 148  
semidome 61  
semigloss 187  
semi-indirect lighting 148  
semivitreous 32  
sensible heat 117  
septic tank 201  
serdab 249  
serendipity 59  
serial distribution 201  
series 74  
Serlian motif 274  
serpentine 236  
service 75  
service conductor 75  
service drop 75  
service entrance conductor 75  
service equipment 75  
service lateral 75  
service load 240  
service pipe 196  
service raceway 78  
service sink 198  
service switch 76  
service temperature 193  
set 47, 82  
setback 221  
set screw 83  
setting block 113  
setting shrinkage 47  
settlement 100  
settlement load 151  
set-up 247  
severy 262  
sewage 200  
sewage treatment plant 201  
sewer 200

- sexpartite vault 263  
 Sezession 134  
 sgraffito 182  
 shade 39, 70  
 shades and shadows 70  
 shading 66  
 shading coefficient 112  
 shadow 70  
 shadow block 160  
 shaft 179, 262  
 shaft grave 248  
 shake 213, 278  
 shallow foundation 100  
 Shang 128  
 shank 82  
 shape 52  
 shear 163  
 shear center 16  
 shear diagram 17  
 shear force 163  
 shear head 205  
 shearing force 163  
 shearing resistance 225  
 shearing strain 163  
 shearing strength 225  
 shearing stress 163  
 shear modulus 163  
 shear plate 85, 173  
 shear strain 163  
 shear stress 163  
 shear stud 93  
 shear wall 243  
 sheath 207  
 sheathing 212, 268  
 sheath pile 221  
 she bolt 45  
 shed dormer 209  
 shed roof 208  
 sheet glass 112  
 sheeting 192  
 sheet metal 172  
 sheet-metal screw 83  
 sheet pile 221  
 Sheetrock 191  
 shell 21, 161, 219  
 shellac 187  
 shellac varnish 187  
 shelter 136  
 shielded cable 78  
 shielded metal arc welding 86  
 shielding angle 146, 273  
 Shimmē-zukuri 255  
 shiner 19  
 shingle 212  
 Shingle style 134  
 shingle tile 214  
 Shinto 255  
 shiplap 268  
 ship's ladder 233  
 shock 76  
 shoe 102, 186, 209, 259, 267  
 shoin 137  
 shoin-zukuri 137  
 shoji 137  
 shoplumber 279  
 shore 221  
 shoring 221  
 shoro 255  
 short 76  
 short circuit 76  
 short column 40  
 short ton 167  
 shotcrete 46  
 shot-sawn 237  
 shoulder 98, 141  
 shoulder miter 140  
 shoved joint 155  
 shower 198  
 shreadhead 208  
 shrinkage 277  
 shrinkage limit 225  
 shrinkage reinforcement 204  
 shrink-mixed concrete 46  
 shutoff valve 196  
 shutter blind 227  
 shutter panel 227  
 shutting stile 64  
 siamese 90  
 side cut 211  
 sidelap 212  
 sidelight 63, 148  
 slidesway 104  
 sliding 268  
 sightline 72, 258  
 slyn 52  
 sikhara 253  
 sikra 253  
 siliceous 42  
 silicon 175  
 silicon bronze 175  
 silicone 193  
 silicone rubber 193  
 sill 63, 267  
 sill anchor 85  
 sill block 160  
 sillcock 197  
 sill plate 267  
 sill sealer 267  
 sit 224  
 similar 109  
 similarity 54, 265  
 simple beam 17  
 simulate 58  
 simultaneous contrast 265  
 sine 109  
 single-acting door 62  
 single-bay frame 105  
 single-bevel weld 86  
 single-curvature structure 29  
 single-duct system 126  
 single-hung window 272  
 single-phase 76  
 single-strength glass 112  
 single tee 206  
 single-vee weld 86  
 sink 198  
 sinking 115  
 siphon-jet 198  
 siphon-vortex 198  
 site 221  
 site coefficient 153  
 site drainage 223  
 site plan 69  
 sitework 221  
 SI unit 166  
 sixteenpenny nail 82  
 size-adjusted value 280  
 sized slates 213  
 size factor 280  
 size perspective 72  
 skeleton construction 106  
 skene 256  
 sketch 67  
 skew 159  
 skew arch 12  
 skewback 14  
 skew corbel 159  
 skew grid 195  
 skew lines 108  
 skim coat 188  
 skin friction 102  
 skip 278  
 skip sheathing 213  
 skirt 186, 271  
 sky component 150  
 skylight 150, 209  
 skyscraper 22  
 slab 26  
 slab on grade 101  
 slag 170  
 slaked lime 157  
 slat block 94  
 slate 236  
 slating nail 213  
 sleeper 94  
 slenderness ratio 40  
 sliding 154  
 sliding door 62  
 sliding sash 272  
 slip 37  
 slip form 45  
 slip matching 283  
 slip mortise 141  
 slipped grid 239  
 slip sill 271  
 slope of grain 280  
 slop sink 198  
 slot diffuser 31  
 slot mortise 141  
 slotted head 83  
 sludge 201  
 sludge clear space 201  
 slump 44  
 slump block 160  
 slump cone 44  
 slump test 44  
 slurry wall 221  
 slype 37  
 small calorie 117  
 smalto 182  
 smelt 170  
 smoke chamber 87  
 smoke detector 90  
 smoke-developed rating 88  
 smoke dome 87

- smokeproof enclosure 91  
 smoke shelf 87  
 smokestack 87  
 smoke vent 89  
 snap tie 45  
 snow load 151  
 soap 19  
 soapstone 236  
 society 128  
 sociology 11  
 socket 79  
 socketed caisson 103  
 sod house 136  
 sodium lamp 145  
 sodium-vapor lamp 145  
 soffit 180  
 soft-burned 32  
 softening point 193  
 soft joint 156  
 soft light 148  
 soft-mud process 18  
 soft steel 170  
 soft story 244  
 softwood 276  
 soil 224  
 soil analysis 224  
 soil binder 270  
 soil class 224  
 soil mechanics 225  
 soil pipe 200  
 soil pressure 100  
 soil profile 224  
 soil stabilizer 270  
 soil stack 200  
 soil structure 225  
 soil vent 200  
 solar 107  
 solar collector 226  
 solar constant 226  
 solar energy 226  
 solar-heating system 226  
 solar house 226  
 solar orientation 226  
 solar path diagram 226  
 solar screen 227  
 solder 86  
 soldier 19  
 soldier beam 221  
 soldier course 20  
 soldier pile 221  
 sole 267  
 solepiece 267  
 soleplate 267  
 solid III, 161  
 solid angle 142  
 solid block flooring 94  
 solid bridging 92  
 solid column 281  
 solid-core door 65  
 solid flat slab 206  
 solid geometry 111  
 solidify 161  
 solid masonry 156  
 solid masonry unit 160  
 solid-top block 160  
 solar 107  
 solvent 187  
 sone 229  
 Sonotube 45  
 sorin 255  
 sound 228  
 sound-absorbing masonry unit 160  
 sound grade 283  
 sound-insulating door 65  
 sound insulation 232  
 sound intensity 229  
 sound-intensity level 229  
 sound isolation 232  
 sound knot 278  
 sound level meter 229  
 sound power 229  
 sound-power level 229  
 sound pressure 229  
 sound-pressure level 229  
 soundproof 230  
 sound transmission class 232  
 sound wave 228  
 space 217  
 spaced column 281  
 spaced sheathing 213  
 spaced slating 213  
 space frame 195  
 space heater 123  
 space heating 121  
 space planning 10  
 spacer 45, 113  
 space truss 195  
 spacing criteria 149  
 spading 46  
 spalling 47  
 span 15  
 spandrel 12, 269  
 spandrel beam 269  
 spandrel glass 112, 269  
 spandril 12, 269  
 Spanish tile 214  
 span rating 282  
 spark arrester 87  
 spark gap 77  
 spar varnish 187  
 spat 65  
 spatialede 72  
 spatter dash 189  
 specialty panel 282  
 specifications 50  
 specific conductance 74  
 specific gravity 167  
 specific heat 117  
 specific humidity 120  
 specific resistance 74  
 specific volume 167  
 spectral distribution curve 145  
 spectrum 38  
 specular 143  
 speculation 59  
 speculative builder 48  
 speed of sound 228  
 sphere 111  
 spherical surface 220  
 spheroid 111  
 sphinx 249  
 spigot 197, 199  
 spike 82  
 spike-and-ferrule 209  
 spike grid 85  
 spill 147  
 spill light 147  
 spindle 116  
 spiral 110  
 spiral column 203  
 spiral reinforcement 203  
 spiral stair 234  
 spire 36  
 spirit level 247  
 spirits of turpentine 187  
 spirit stain 187  
 spirit varnish 187  
 splash block 209  
 splay 63, 185  
 splayed coping 266  
 splice plate 174  
 spline 31, 140  
 split 278  
 split complementary 39  
 split-face block 160  
 split-faced 237  
 split-level 138  
 split-ring 85  
 spot 147, 257  
 spot elevation 247  
 spotlight 147, 257  
 spray-on fireproofing 88  
 spread 122  
 spreader 45  
 spread footing 101  
 sprig 113  
 spring 12  
 spring balance 272  
 spring equinox 226  
 springer 12  
 spring hinge 115  
 springing 12  
 spring steel 170  
 springwood 276  
 sprinkler head 90  
 sprinkler system 90  
 sprinklered 90  
 sprocket 213  
 spur 183  
 square 109, 212  
 squared rubble 158  
 square head 84  
 square measure 166  
 square splice 140  
 squinch 61  
 S-shape 172  
 stability 243  
 stabilizer 192  
 stabilizing moment 153  
 stack 122, 200  
 stack bond 20  
 stack partition 199  
 stack vent 200  
 stadia 247  
 stadia rod 247

- staff bead 271  
 stage 257  
 stagehouse 257  
 staggered course 212  
 staggered joints 212  
 staggered-stud partition 232  
 staging 49  
 stain 187  
 stained glass 37  
 stainless steel 170  
 stair 233  
 staircase 235  
 stairhead 233  
 stair headroom  
 stair lift 81  
 stair rod 235  
 stairway 233  
 stairwell 233  
 stalactite work 252  
 stamba 253  
 stanchion 235  
 standing leaf 62  
 standard atmosphere 167  
 Standard Building Code 51  
 standard candle 142  
 standard hook 202  
 standard pipe 172  
 standard terrazzo 94  
 standby generator 75  
 standing seam 214  
 standing wave 231  
 standpipe 90  
 staple 82  
 star 183  
 Star of David 183  
 starter 145  
 starter tile 214  
 starting course 212  
 star vault 263  
 statically equivalent 97  
 static fit 57  
 static load 151  
 static load test 102  
 statics 97  
 station 247  
 station point 72  
 statute mile 166  
 stove church 36  
 Steamboat Gothic 134  
 steam heating 123  
 steam trap 123  
 steatite 236  
 steel 170  
 steel beam 173  
 steel column 174  
 steeple 36  
 Steiner tunnel test 88  
 stele 250  
 stellar vault 263  
 step 233  
 step-down transformer 75  
 step flashing 177  
 stepped flashing 177  
 stepped footing 101  
 stepped ramp 233  
 stepping off 211  
 step-up transformer 75  
 steradian 142  
 stereobate 250  
 Stick style 134  
 stick system 269  
 stiffback 45  
 stiffener 173  
 stiff mix 44  
 stiff-mud process 18  
 stiffness 164  
 stile 64  
 Stile Liberty 134  
 stilt 106  
 stilted arch 14  
 stilted vault 263  
 stipple-troweled finish 189  
 stippling 66  
 stirrup 203  
 stoa 250  
 stone 236  
 Stone Age 128  
 Stonehenge 248  
 stoneware 32  
 stool 271  
 stoop 25  
 stop 63, 186, 272  
 stop bead 272  
 stop chamfer 140  
 stopped dado 140  
 stopped mortise 141  
 storm cellar 23  
 storm door 64  
 storm drain 223  
 storm sewer 223  
 storm window 274  
 story 22, 24  
 story drift 153  
 story shear 153  
 stovebolt 84  
 stovepipe 121  
 straight flight 234  
 straight-run stair 234  
 straight-split shake 213  
 strain 162  
 strain gauge 162  
 strain-hardening range 164  
 straining beam 210  
 straining piece 210  
 straining sill 210  
 strain-rate effect 165  
 strand 206  
 strap footing 101  
 strap hinge 115  
 strapwork 184  
 stratification 46  
 stratum 224  
 strength 162  
 strength of materials 162  
 stress 162  
 stress concentration 163  
 stress design 240  
 stressed-skin panel 50  
 stress grade 280  
 stress relaxation 165  
 stress relieving 169  
 stress reversal 259  
 stress-strain diagram 164  
 stress trajectories 16  
 stretcher 19  
 stretcher block 160  
 stretcher bond 20  
 stretching course 20  
 strla 180  
 strike 116  
 strike plate 116  
 string 235  
 stringboard 235  
 string course 159  
 stringer 92, 235  
 strip 83  
 strip flooring 94  
 strip footing 101  
 strip lath 190  
 strongback 45  
 struck joint 155  
 structural analysis 240  
 structural clay tile 34  
 structural design 240  
 structural dimension 57  
 structural facing tile 34  
 structural failure 240  
 structural grid 239  
 structural insulating roof deck 215  
 structural lightweight concrete 43  
 structural lumber 279  
 structural member 238  
 structural pattern 239  
 structural rating 240  
 structural sealant 113  
 structural sheathing 268  
 structural steel 173  
 structural tee 172  
 structural tubing 172  
 structural unit 239  
 structure 53, 238  
 structure-borne sound transmission 232  
 strut 238  
 stub tenon 141  
 stucco 189  
 stud 267  
 studio apartment 139  
 stud partition 267  
 stud wall 267  
 study 67  
 stupa 253  
 style 128  
 Style Moderne 135  
 stylobate 250  
 Styrofoam 119  
 subbasement 23  
 subcasing 63  
 subcontractor 48  
 subdiagonal 261  
 subfloor 92  
 subgrade 222  
 submerged arc welding 86  
 subpurlin 210  
 subsill 271  
 subsoil 224

# INDEX

- substation 75
- subtractive color 38
- substrate 101, 178
- substratum 101
- substructure 21
- subsurface drainage 223
- subsurface investigation 225
- subsurface sand filter 201
- subtractive 52
- suction 18, 190
- suite 216
- sulfate action 42
- Sumertan architecture 128
- summer 107
- summer solstice 226
- summertree 107
- summerwood 276
- sump 200
- sump pump 200
- sun control 227
- sun deck 227
- sunk draft 237
- sunk panel 268
- sunk relief 182
- sunlight 150
- sun parlor 227
- sun porch 227
- sunroom 227
- sunshade 227
- supercolumniation 256
- superplasticizer 43
- superstructure 21
- supply air 125
- supply pipe 126
- support condition 242
- surbased arch 14
- surcharge 270
- surface 111
- surface-active agent 43
- surface-active structure 238
- surface bonding 160
- surface condensation 176
- surface drainage 223
- surfaced dry 277
- surfaced green 277
- surface structure 238
- surface tension 177
- surfactant 43
- surround 27, 268
- surround theater 257
- survey 246
- surveyor's chain 247
- survey plat 246
- suspended ceiling 31
- suspended-span 17
- suspension bridge 29
- suspension structure 29
- swale 223
- swan's neck pediment 186
- sway brace 243
- sweating 176
- sweep 62
- sweep fitting 199
- swinging door 62
- swirl finish 47
- switch 79
- switchboard 75
- switchgear 75
- switchgear room 75
- symbol 52
- symmetry 55
- synagogue 250
- synclastic 220
- synectics 59
- synthesis 58
- synthetic rubber 193
- syrinx 249
- system 21
- systems building 50
- systyle 179
- Tt**
- tabernacle 36, 250
- tabernacle frame 186
- table 159, 183
- tablero 252
- tablet 183
- tactile texture 52
- taenia 180
- tag 177
- tail 213
- tail cut 213
- tail in 159
- talling 159
- tallpiece 92, 211
- talud 252
- tambour 61
- tana 137
- Tang 254
- tangent 109, 110
- tangential shrinkage 277
- tangential stress 163
- Tao 129
- Taoism 129
- tap 83, 197
- tapered column 281
- tapered end form 204
- tapersplit shake 213
- tapping screw 83
- target 247
- task lighting 148
- taste 10
- tatami 137
- T-bar 172
- TB bulb 144
- T-beam 203
- T bulb 145
- teaser 257
- technics 11
- technique 66
- technology 11
- tectonics 11
- tee 172, 199, 253
- teepee 136
- tegula 214
- telamon 250
- tell 128
- temenos 250
- temper 169
- temperature 117
- temperature effect 165
- temperature reinforcement 204
- tempered glass 112
- tempered hardboard 284
- template 266
- template hinge 115
- temple 248
- Temple of Solomon 250
- templet 266
- tendon 206
- tenia 180
- tenon 141
- tensile force 162
- tensile strain 162
- tensile strength 162
- tensile stress 162
- tensile test 162
- tension 54, 162
- tension-control bolt 174
- tension member 238
- tension reinforcement 202
- tension ring 60
- tent structure 168
- tepee 136
- terminal 79
- terminal reheat system 126
- terminal unit 126
- terminal velocity 122
- termite shield 267
- terne metal 175
- terneplate 175
- terra cotta 34
- terrace 25, 139
- terrace house 139
- terrazzo 94
- terreplein 98
- territoriality 57
- tertiary beam 106
- tertiary color 39
- tertiary member 241
- tessera 182
- test 58
- test cylinder 44
- test pit 221
- tetrahedron 111
- tetrastyle 179
- texture 52, 53
- texture 1-11 282
- texture perspective 72
- thatch 107
- theater 256
- theater-in-the-round 257
- theodolite 247
- theory 59
- therm 117
- thermal barrier 118
- thermal break 118
- thermal comfort 120
- thermal conductance 118
- thermal conductivity 118
- thermal contraction 165
- thermal expansion 165
- thermal finish 237
- thermal insulation 119
- thermal resistance 118

- thermal shock 165  
 thermal stress 165  
 thermal transmittance 118  
 thermocouple 121  
 thermoforming 192  
 thermometer 117  
 thermoplastic 192  
 thermoset 193  
 thermosetting plastic 193  
 thermostat 121  
 thick-set process 33  
 thimble 121  
 thin-bed process 33  
 thin-coat plaster 188  
 T-hinge 115  
 thinner 187  
 thin-set terrazzo 94  
 thin shell 219  
 tholobate 61  
 tholos 248  
 thread 83  
 three-coat plaster 188  
 three-hinged arch 13  
 three-hinged frame 104  
 three-phase 76  
 three-point perspective 73  
 three-quarter-turn stair 234  
 three-way lamp 144  
 three-way switch 79  
 threshold 63, 218  
 threshold of hearing 229  
 threshold of pain 229  
 throat 65, 86, 87  
 through check 278  
 through stone 158  
 through tenon 141  
 through-wall flashing 177  
 throw 122, 149  
 thrust 13  
 thrust stage 257  
 thumbnut 84  
 thumbscrew 83  
 Tlahuanaco 130  
 tie 156, 238  
 tieback 221  
 tie beam 103, 210  
 tied column 203  
 tier 258  
 tierceron 263  
 tie rod 13  
 tight fit 216  
 tight knot 278  
 tile accessory 33  
 tile grout 33  
 tile tie 214  
 tilting fillet 214  
 tilt-up construction 50  
 timber 277  
 timber connector 85  
 timber pile 102  
 timbers 279  
 time-delay fuse 76  
 time of haul 46  
 tin 171  
 tinplate 171  
 tin roofing 214  
 tint 39  
 tinted glass 112  
 to 255  
 toe 86, 270  
 toenail 82  
 toggle bolt 84  
 toggle switch 79  
 toilet 198  
 toilet partition 198  
 tokobashira 137  
 tokonoma 137  
 Toltec architecture 131  
 ton 167  
 tone 39  
 tongue-and-groove 140  
 tongued miter 140  
 tonne 167  
 ton of refrigeration 124  
 tooled joint 155  
 tooled surface 237  
 toothed plate 85  
 top bar 203  
 top car clearance 80  
 topcoat 187  
 top cut 211  
 tope 253  
 toplary 27  
 toplap 212  
 top out 49  
 topping 94, 204, 206  
 top plate 267  
 top rail 64  
 topsoil 224  
 torana 253  
 torchiere 147  
 toril 255  
 tormentor 257  
 torque 163  
 torsion 163  
 torsional irregularity 244  
 torus 181, 220  
 totem 136  
 totem pole 136  
 tou 254  
 toughness 164  
 tou-kung 254  
 tourelle 99  
 tower 26  
 Tower of Babel 248  
 town planning 10  
 township 246  
 trabeate 106  
 trace 66  
 tracery 275  
 tracheld 276  
 trachelium 180  
 track lighting 147  
 tract house 138  
 traction elevator 80  
 transept 36  
 transfer column 105  
 transfer girder 105  
 transfer molding 192  
 transformation 58  
 transformer 75  
 transformer vault 75  
 transit 247  
 transition 218  
 transitional structure 239  
 transit-mixed concrete 46  
 translation 97  
 translational surface 219  
 translucent 143  
 transmission loss 232  
 transmittance 143  
 transom 63  
 transom light 63  
 transom window 63  
 transparent 143  
 transverse arch 262  
 transverse force 163  
 transverse load 163  
 transverse rib 263  
 transverse section 70  
 transverse shear 15  
 trap 198  
 trapezium 109  
 trapezoid 109  
 trave 107  
 travel 80  
 traveling cable 80  
 traverse 246  
 travertine 236  
 tread 233  
 tread return 235  
 treated wood 280  
 trefoil 275  
 trefoil arch 14  
 trellis 27  
 tremie 221  
 triad 39  
 triangle 109  
 triangle method 96  
 triangular arch 14  
 triangulation 247  
 tribunal 251  
 tribune 35, 251  
 tributary 241  
 tributary area 241  
 tributary load 241  
 tricalcium aluminate 42  
 tricalcium silicate 42  
 triforium 37  
 triglyph 180  
 trigonometric function 109  
 trigonometry 109  
 trilateration 247  
 trillith 248  
 trillithon 248  
 trim 186  
 trimetric projection 71  
 trimmer 33, 92  
 trimmer arch 87  
 tripartite vault 263  
 triphosphor 145  
 triple point 117  
 triplex 138  
 tristyle 179  
 triumphal arch 251

# INDEX

---

orking load 240  
orking stress 164  
orking stress design 240  
ork plane 149  
oven carpet 95  
oven valley 212  
oven-wire fabric 202  
eathe 184, 234  
eathe piece 234  
rought iron 170  
-shape 172  
ye 199  
ythe 155

x  
axis 108  
bracing 243  
coordinate 108  
a 128  
lem 276

y  
ng-shao 128  
rd 166  
rd lumber 279  
axis 107  
coordinate 107  
ld point 102, 164  
ld strength 164  
n 128  
ke 45, 272  
ng's modulus 162  
ngang 254  
rt 136

z  
potec architecture 130  
shiki 137  
xis 108  
zar 172  
coordinate 108  
: 172  
ith 150  
o-force member 259  
nglou 254  
ou 129  
gurat 248  
c 171  
ada 252  
al cavity method 149  
e 126  
ng ordinance 51  
horus 180  
nger 133



Architecture is an art for all to learn because all are concerned with it. —John Ruskin • Architecture depends on Order, Arrangement, Eurythmy, Symmetry, Propriety, and Economy. All of these must be built with due reference to durability, convenience, and beauty. Durability will be assured when foundations are carried down to the solid ground and materials wisely and liberally selected; convenience, when the arrangement of the apartments is faultless and presents no hindrance to use, and when each class of building is assigned to its suitable and appropriate exposure; and beauty, when the appearance of the work is pleasing and in good taste, and when its members are in due proportion according to correct principles of symmetry. —Vitruvius • Architecture is the masterly, correct and magnificent play of masses brought together in light. —Le Corbusier • Anyone entering on the study of architecture must understand that even though a plan may have abstract beauty on paper, the four facades may seem well balanced and the total volume well proportioned, the building itself may turn out to be poor architecture. Internal space, that space which cannot be completely represented in any form, which can be grasped and felt only through direct experience, is the protagonist of architecture. To grasp space, to know how to see it, is the key to the understanding of building. —Bruno Zevi • Architecture, painting, and sculpture are called the fine arts. They appeal to the eye as music does to the ear. But architecture is not judged by visual appeal alone. Buildings affect all of the human senses — sound, smell, touch, taste, and vision. —Forrest Wilson • It became apparent to us that architecture is generally assumed to be a highly specialized system with a set of prescribed technical goals rather than a sensual social art responsive to real human desires and feelings. This limitation is most frighteningly manifested in the reliance on two-dimensional diagrams that lay more stress on the quantifiable features of building organization than on the polychromatic and three-dimensional qualities of the whole architectural experience. —Kent Bloomer & Charles Moore • The only way you can build, the only way you can get the building into being, is through the measurable. You must follow the laws of nature and use quantities of brick, methods of construction, and engineering. But in the end, when the building becomes part of living, it evokes unmeasurable qualities, and the spirit of its existence takes over. —Louis Kahn • Built environments have various purposes: to shelter people and their activities and possessions from the elements, from human and animal enemies, and from supernatural powers; to establish place; to create a humanized, safe area in a profane and potentially dangerous world; to stress social identity and indicate status; and so on. Thus the origins of architecture are best understood if one takes a wider view and considers sociocultural factors, in the broadest sense, to be more important than climate, technology, materials, and economy. In any situation, it is the interplay of all these factors that best explains the form of buildings. No single explanation will suffice, because buildings — even apparently humble dwellings — are more than material objects or structures. They are institutions, basic cultural phenomena. People think environments before they build them. Thought orders space, time, activity, status, roles, and behavior. But giving physical expression to ideas is valuable. Encoding ideas makes them useful mnemonics; ideas help behavior by reminding people of how to act, how to behave, and what is expected of them. It is important to stress that all built environments — buildings, settlements, and landscapes — are one way of ordering the world by making ordering systems visible. The essential step, therefore, is the ordering or organizing of the environment. —Amos Rapaport • Ruskin said: 'Great nations write their autobiographies in three manuscripts, the book of their deeds, the book of their words and the book of their art. Not one of these books can be understood unless we read the two others, but of the three the only trustworthy one is the last.' On the whole I think this is true. If I had to say which was telling the truth about society, a speech by a minister of housing or the actual buildings put up in his time, I should believe the buildings. —Kenneth Clark • We require of any building, that it act well, and do the things it was intended to do in the best way; that it speak well, and say the things it was intended to say in the best words; that it look well, and please us by its presence, whatever it has to do or say. —John Ruskin • Architecture also exists without necessary assistance from an architect; and architects sometimes create buildings which are not architecture. —Norval White • Architecture is produced by ordinary people, for ordinary people; therefore it should be easily comprehensible to all. —Steen Eiler Rasmussen